

Public Hearing: YES NO

Department: Planning & Sustainability

SUBJECT:

COMMISSION DISTRICT(S): 4 & 6

Application of Mosaic Communities c/o Battle Law to rezone properties from R-85 (Residential Medium Lot) District to RSM (Small Lot Residential Mix) District to allow single-family cottages, duplexes, and triplexes, at 3943 Norman Road.

PETITION NO: N4. Z-21-1244893 (2021-2641)

PROPOSED USE: Single-family cottages, duplexes and triplexes.

LOCATION: 3943 Norman Road.

PARCEL NO. : 18-095-03-005; 18-095-03-006; 18-095-03-008; 18-095-03-009; 18-095-03-090; 18-095-03-094

INFO. CONTACT: John Reid, Sr. Planner

PHONE NUMBER: 404-371-4950

PURPOSE:

Application of Mosaic Communities c/o Battle Law to rezone properties from R-85 (Residential Medium Lot) District to RSM (Small Lot Residential Mix) District to allow single-family cottages, duplexes, and triplexes. The property is located on south side of Norman Road, approximately 292 feet west of Viking Drive and at the terminus of Spartan Lane at 3943, 4021, 4029, 4039, 4069, and 4083 Norman Road in Stone Mountain, Georgia. The property has approximately 775 feet of frontage along Norman Road and contains 35 acres.

RECOMMENDATION:

COMMUNITY COUNCIL: Full Cycle Deferral.

PLANNING COMMISSION: Pending.

PLANNING STAFF: Full Cycle Deferral.

STAFF ANALYSIS: Based on the submitted information, it cannot be determined if the zoning proposal is in conformity with the policy and intent of the *Comprehensive Plan* or if it is suitable in view of the use and development of nearby properties. The applicant is in the process of revising the plan to address compliance with DeKalb County zoning requirements including but not limited to the following: 1. Indicate what specific types of enhanced open space are being provided (i.e. pocket parks, neighborhood park, greenway trail, etc.) to comply with the enhanced open space requirements of the zoning ordinance; 2. Verify that the single-family cottage elevations and design layout are in compliance with maximum building height requirements (1.5 stories) and that all are clustered around enhanced open space as required by zoning ordinance; 3. Review the proposed shared access off Norman Road on the northwest corner of the site (opposite Otello Avenue) with the county's transportation department to ensure compliance with transportation requirements; 4. Ensure that project will incorporate at least two fee simple lots so it can qualify for density bonuses; 5. Show floodplain, stream buffer, and tree preservation areas; 6. Provide larger chunks of greenspace through more clustering of residential units. The applicant has requested that this case be deferred for a full cycle to allow an opportunity to address these issues (see attached). Therefore, it is the recommendation of the Planning and Sustainability Department that the rezoning application be "Deferred, full cycle" to allow the opportunity for the applicant to address these issues

and allow the DeKalb County Transportation Department sufficient time to review the applicant's Traffic Impact Study to determine if any road improvements are necessary.

PLANNING COMMISSION VOTE: Pending.

COMMUNITY COUNCIL VOTE/RECOMMENDATION: Full Cycle Deferral 13-0-0. Discussion included instructing the applicant to work with the community to address potential flooding, traffic and land use compatibility impacts.



DeKalb County Department of Planning & Sustainability

330 Ponce De Leon Avenue, Suite 500

Decatur, GA 30030

(404) 371-2155 / plandev@dekalbcountyga.gov

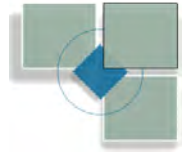

Michael Thurmond
Chief Executive Officer

Planning Commission Hearing Date: July 8, 2021
Board of Commissioners Hearing Date: July 29, 2021

STAFF ANALYSIS

Case No.:	Z-21-124893	Agenda #: N4
Location/ Address:	The south side of Norman Road, approximately 292 feet west of Viking Drive and at the terminus of Spartan Lane at 3943, 4021, 4029, 4039, 4069, and 4083 Norman Road in Stone Mountain, Georgia	Commission District: 4 Super District: 6
Parcel ID:	18-095-03-005, 18-095-03-006, 18-095-03-008, 18-095-03-009, 18-095-03-090, 18-095-03-094	
Request:	To rezone properties from R-85 (Residential Medium Lot-85) District to RSM (Small Lot Residential Mix) District to allow single-family cottages, duplexes, and triplexes.	
Property Owner:	Hugh Spivey, Mary Ben Spivey, Charles Marvin Spivey, Kay Spivey Sims, Harry Stephen Spivey	
Applicant/Agent:	Mosaic Communities LLC c/o Battle Law	
Acreage:	35	
Existing Land Use:	Vacant land and Single-Family homes	
Surrounding Properties:	Single-family detached subdivisions	
Adjacent Zoning:	North: R-85 South: R-85 East: R-85 West: R-85	
Comprehensive Plan:	SUB (Suburban)	Consistent <input checked="" type="checkbox"/> Inconsistent <input type="checkbox"/>
Proposed Density:	6.5 units per acre	Existing Density: NA
Proposed Units/Square Ft.:	228 residential units comprising of single-family cottages, duplexes, and triplexes.	Existing Units/Square Feet: Vacant Land and Single-Family Homes
Proposed Lot Coverage:	NA	Existing Lot Coverage: NA

Staff Recommendation: FULL CYCLE DEFERRAL

ZONING HISTORY

Based on DeKalb County records, it appears that the R-85 zoning of the property has not changed since adoption of the first *Zoning Ordinance* and map in 1956.

PROJECT ANALYSIS

The subject property comprises 35 acres on the south side of Norman Road, approximately 292 feet west of Viking Drive and at the terminus of Spartan Lane at 3943, 4021, 4029, 4039, 4069, and 4083 Norman Road in Stone Mountain, Georgia. The site contains vacant land and single-family structures. The site slopes moderately upward from the west to east. The site currently has an abundance of mature trees and vegetation. Spivey Lake consumes a significant portion of the west side of the project site. The general site layout consists of a mixture of housing types including single-family detached cottages, duplexes, and triplexes. The proposed single-family detached cottages are clustered around courtyard pocket parks. All proposed uses have internal pedestrian sidewalks and walking trails to connect to Spivey Lake. There is a large community forest along approximately half of the Norman Road property frontage which proposes to preserve the existing tree canopy, natural open space, and provide an appropriate visual screen from surrounding properties.

The RSM district allows a base density of four (4) units per acre, with density up to eight (8) units per acre if certain community enhancements or provisions are provided. To achieve a density of 6.5 units per acre, the applicant is requesting a 50% density bonus based on the inclusion of enhanced open space (i.e. $4 \text{ DU/AC} \times 50\% = 2 \text{ DU/AC}$; $4+2=6 \text{ DU/AC}$ (maximum)). To get this type of density bonus, at least 20% open space must be enhanced open space such as dog parks, pocket parks, pool amenities, etc.. The site plan indicates that the applicant is providing much more open space than required (i.e. 20% required (7 acres); 58.8% provided (20.54 acres)), and that 32% of the open space is enhanced open space consisting of cottage courtyards, community forest, community garden, and natural walking trails. The applicant is also requesting a 20% density bonus ($6 \text{ DU/AC} \times 20\% = .8$; $6 + .8 = 6.8 \text{ DU/AC}$) for providing off-site pedestrian connections to the nearby public school (Jolly Elementary School) and for being within a quarter mile of a public amenity (Jolly Elementary School).

There are three access points for the project; two access points off of Norman Road and one access off of Spartan Drive on the southeast corner of the site. Per County subdivision regulations, the proposed 228 residential units would require three access points. The applicant has submitted a Traffic Impact Study to the DeKalb County Transportation Department which is currently under review. The applicant will need to obtain a sewer capacity letter from the Department of Watershed Management to verify if sewer capacity is available.

The applicant is in the process of revising the plan to address compliance with DeKalb County zoning requirements including but not limited to the following:

1. Indicate what specific types of enhanced open space are being provided (i.e. pocket parks, neighborhood park, greenway trail, etc.) to comply with the enhanced open space requirements of the *Zoning Ordinance*;
2. Verify that the single-family cottage elevations and design layout are in compliance with maximum building height requirements (1.5 stories) and that all cottages are clustered around enhanced open space as required by *Zoning Ordinance*;
3. Review the proposed shared access off Norman Road on the northwest corner of the site (opposite Otello Avenue) with the county's transportation department to ensure compliance with transportation requirements;

4. Ensure that project will incorporate at least two fee simple lots so it can qualify for density bonuses;
5. Show floodplain, stream buffer, and tree preservation areas.
6. Provide larger chunks of greenspace through more clustering of residential units.

Supplemental Requirements: N/A

Compliance with District Standards: The applicant is requesting a full cycle deferral to allow sufficient time to revise the plan to address compliance with DeKalb County zoning requirements.

LAND USE AND ZONING ANALYSIS

Section 27-7.3.5 of the Zoning Ordinance, “Standards and factors governing review of proposed amendments to the official zoning map” states that the following standards and factors shall govern the review of all proposed amendments to the zoning maps.

A. Whether the zoning proposal is in conformity with the policy and intent of the comprehensive plan:

A well designed project which preserves significant environmental resources and provides a mixture of housing types may be consistent with the following policies and strategies of the Suburban Character Area:

1. Promote strong connectivity and continuity between existing and new development (Suburban Policy #10).
2. Create neighborhood focal points through the use of existing pocket parks and square for community activities (Suburban Policy #16).
3. Utilize the zoning code to provide a variety of housing opportunities and choices to better accommodate the needs of residents. Mixed use developments shall include a variety of home styles, densities and price ranges in locations that are accessible to jobs and services (Housing Policy #9).

However, it cannot be determined if the zoning proposal is in conformity with the policy and intent of the *Comprehensive Plan* at this time. The applicant is requesting a full cycle deferral (see attached) to allow sufficient time to revise the plan to address compliance with DeKalb County zoning requirements.

B. Whether the zoning proposal will permit a use that is suitable in view of the use and development of adjacent and nearby properties:

It cannot be determined if the zoning proposal will permit a use that is suitable in view of the use and development of nearby properties. The applicant is requesting a full cycle deferral to allow sufficient time to revise the plan to address compliance with DeKalb County zoning requirements (see attached).

C. Whether the property to be affected by the zoning proposal has a reasonable economic use as currently zoned:

It appears that the property may have a reasonable economic use as currently zoned R-85 which allows single-family detached residential development.

D. Whether the zoning proposal will adversely affect the existing use or usability of adjacent or nearby property:

It cannot be determined if the zoning proposal will adversely affect the existing use or usability of adjacent or nearby property. There will be additional traffic along Norman Road and Spartan Lane from the proposed development, and the applicant has submitted a Traffic Impact Study to the DeKalb County Transportation Department which is currently under review. The applicant is requesting a full cycle deferral to allow sufficient time for the Transportation Department to review the traffic study and to revise the plan to address compliance with DeKalb County zoning requirements.

E. Whether there are other existing or changing conditions affecting the use and development of the property, which give supporting grounds for either approval or disapproval of the zoning proposal:

The applicant is requesting a full cycle deferral to allow sufficient time to revise the plan to address compliance with DeKalb County zoning requirements. See additional information in Criterion H regarding school impacts.

G. Whether the zoning proposal will adversely affect historic buildings, sites, districts, or archaeological resources:

Based on the submitted information, no historic buildings, sites, districts, or archaeological resources are located on the subject property or in the surrounding area.

H. Whether the zoning proposal will result in a use which will or could cause an excessive or burdensome use of existing streets, transportation facilities, utilities, or schools:

There has been no indication from reviewing departments and agencies that the proposal would cause excessive use of utilities. However there may be school impacts. When fully constructed, this development is expected to generate 91 students, 10 at Jolly Elementary School, 12 at Freedom Middle School, 16 at Clarkston High School, 29 at other DCSD schools, and 24 at private schools. Jolly Elementary School and Clarkston High School are already over capacity and new students from this development may require additional portable classrooms. The DeKalb County Transportation Department is currently reviewing the applicant's Traffic Impact Study. The applicant will need to obtain a sewer capacity letter from the Department of Watershed Management to verify if sewer capacity is available. The applicant is requesting a full cycle deferral to allow sufficient time for the Transportation Department to review the traffic study and to revise the plan to address compliance with DeKalb County zoning requirements.

I. Whether the zoning proposal adversely impacts the environment or surrounding natural resources:

It cannot be determined if the zoning proposal will adversely impact the environment or surrounding natural resources. The applicant is requesting a full cycle deferral to allow sufficient time to revise the plan to address

compliance with DeKalb County zoning requirements.

Planning and Sustainability Department Recommendation: FULL CYCLE DEFERRAL

Based on the submitted information, it cannot be determined if the zoning proposal is in conformity with the policy and intent of the *Comprehensive Plan* or if it is suitable in view of the use and development of nearby properties. The applicant is in the process of revising the plan to address compliance with DeKalb County zoning requirements including but not limited to the following:

1. Indicate what specific types of enhanced open space are being provided (i.e. pocket parks, neighborhood park, greenway trail, etc.) to comply with the enhanced open space requirements of the zoning ordinance;
2. Verify that the single-family cottage elevations and design layout are in compliance with maximum building height requirements (1.5 stories) and that all are clustered around enhanced open space as required by zoning ordinance;
3. Review the proposed shared access off Norman Road on the northwest corner of the site (opposite Otello Avenue) with the county's transportation department to ensure compliance with transportation requirements;
4. Ensure that project will incorporate at least two fee simple lots so it can qualify for density bonuses;
5. Show floodplain, stream buffer, and tree preservation areas.
6. Provide larger chunks of greenspace through more clustering of residential units.

The applicant has requested that this case be deferred for a full cycle to allow an opportunity to address these issues (see attached). Therefore, it is the recommendation of the Planning and Sustainability Department that the rezoning application be "deferred, full cycle" to allow the opportunity for the applicant to address these issues and allow the DeKalb County Transportation Department sufficient time to review the applicant's Traffic Impact Study to determine if any road improvements are necessary.

Attachments:

1. Public Works Department Comments
 - a. Land Development Division
 - b. Traffic Engineering Division
2. Watershed Management Department Comments
3. Board of Health Comments
4. Board of Education Comments
5. Application
6. Site Plan
7. Zoning Map
8. Aerial Photograph

9. Photographs

June 29, 2021

VIA EMAIL

Brandon White, Zoning Manager
DeKalb County Planning & Sustainability Dept
330 W. Ponce de Leon Avenue
Decatur, GA 30030

Re: Z-21-1244895 Norman Road
Applicant: Mosaic Communities

Dear Brandon,

On behalf of my client, Mosaic Communities, I am hereby requesting a full cycle deferral of the above-reference Rezoning Application.

Please do not hesitate to contact me should you have any questions.

Sincerely,

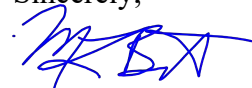

Michèle L. Battle



DEKALB COUNTY GOVERNMENT
PLANNING DEPARTMENT
DISTRIBUTION FORM

NOTE: PLEASE RETURN ALL COMMENTS VIA EMAIL OR FAX TO EXPEDITE THE PROCESS TO MICHELLE M ALEXANDER mmalexander@dekalbcountyga.gov OR JOHN REID JREID@DEKALBCOUNTYGA.GOV

COMMENTS FORM:
PUBLIC WORKS WATER AND SEWER

Case No.: Z-21-1244893

Parcel I.D. #: 18-095-03-005, -006, -008, -009, -090, -094

Address: 3943, 4039, 4069, 4021, 4083, and 4029 Norman Road

Stone Mountain, Georgia

WATER:

Size of existing water main: 6" CI and 12" CI Water Main (adequate/inadequate)

Distance from property to nearest main: Adjacent to Property

Size of line required, if inadequate: N/A

SEWER:

Outfall Servicing Project: Snapfinger Creek Basin

Is sewer adjacent to property: Yes (X) No () If no, distance to nearest line: _____

Water Treatment Facility: Snapfinger WTF () adequate () inadequate

Sewage Capacity; * (MGPD)

Current Flow: 21.77 (MGPD)

COMMENTS:

* Please note that the sewer capacity has not been reviewed or approved for this project. A Sewer Capacity Request (SCR) must be completed and submitted for review. This can be a lengthy process and should be addressed early in the process.

No SCR on file for Norman Rd.

A. Taylor

Signature: *Carlo B.*

Zoning Comments

N1 & N2 (Z-21-1244885 & SLUP-21-1244886) - North Druid Hills is classified as a major arterial. Required to add a left turn lane onto Birch. Drive on North Druid Hills limited to Right in/right out only. Please see chapter 5 of the zoning code and chapter 14-190 of the land development code for infrastructure requirements. Requires 10 foot landscape strip, bike lanes and 6 foot sidewalks or 10 foot multiuse path (preferred), street lighting on back of sidewalk. Right of way dedication of 50 feet from centerline or such that all public infrastructure is within county right of way, whichever greater. Birch Road is classified as a local street. Requires a 27.5 foot right of way dedication from the centerline or such that all public infrastructure is on county right of way. Due to the proximity of the mall, potential for redevelopment and connectivity the residential areas- a 10 foot multiuse trail to be included in the sight design along Birch. Requires a 6 foot landscape strip. Streetlights required on back of path.

N3. (Z-21-1244892) Flakes Mill Road is classified as a minor arterial. Access point on Flakes Mill Road must meet intersection sight distance prior to permitting and verified prior to occupancy by the engineer of record. Please see chapter 5 of the zoning code and chapter 14-190 of the land development code for infrastructure requirements. Requires 10 foot landscape strip, bike lanes and 6 foot sidewalks or 10 foot multiuse path (preferred), street lighting on back of sidewalk. Right of way dedication of 40 feet from centerline or such that all public infrastructure is within county right of way, whichever greater. New residential streets will be local with a right of way of 55 feet, 24 feet of pavement, curb and gutter, 6 foot landscape strip, a 6 foot sidewalk, street lighting required behind sidewalk.

N4. (Z-21-1244893) Norman Road is classified as a collector road. Please see chapter 5 of the zoning code and chapter 14-190 of the land development code for infrastructure requirements. Requires 10 foot landscape strip, bike lanes and 6 foot sidewalks or 10 foot multiuse path (preferred), street lighting on back of sidewalk. Right of way dedication of 35 feet from centerline or such that all public infrastructure is within county right of way, whichever greater. New residential streets will be local with a right of way of 55 feet, 24 feet of pavement, curb and gutter, 6 foot landscape strip, a 6 foot sidewalk, street lighting required on back of sidewalk. Continue at least 2 traffic calming features (splitter islands) similar to the ones installed in the City of Clarkton along frontage.

N5. (SLUP-21-1244895) No comment

N6. (SLUP-21-1244899) No comment

**Board of Health**

06/21/2021

To: Mr. John Reid, Senior Planner
From: Ryan Cira, Environmental Health Manager
Cc: Alan Gaines, Technical Services Manager
Re: Rezone Application Review

General Comments:

DeKalb County Health Regulations prohibit use of on-site sewage disposal systems for

- multiple dwellings
- food service establishments
- hotels and motels
- commercial laundries
- funeral homes
- schools
- nursing care facilities
- personal care homes with more than six (6) clients
- child or adult day care facilities with more than six (6) clients
- residential facilities containing food service establishments

If proposal will use on-site sewage disposal, please contact the Land Use Section (404) 508-7900.

Any proposal, which will alter wastewater flow to an on-site sewage disposal system, must be reviewed by this office prior to construction.

This office must approve any proposed food service operation or swimming pool prior to starting construction.

Public health recommends the inclusion of sidewalks to continue a preexisting sidewalk network or begin a new sidewalk network. Sidewalks can provide safe and convenient pedestrian access to a community-oriented facility and access to adjacent facilities and neighborhoods.

For a public transportation route, there shall be a 5ft. sidewalk with a buffer between the sidewalk and the road. There shall be enough space next to sidewalk for bus shelter's concrete pad installation. Recommendation: Provide trash can with liner at each bus stop with bench and monitor for proper removal of waste.

Since DeKalb County is classified as a Zone 1 radon county, this office recommends the use of radon resistant construction.



Board of Health

- N.1 Z-21-1244885 2021-2678/18-100-04-019
District 02 Super District 06
3795 North Druid Hills Road, Decatur, GA 30033
Acres: 1.04
- Please review general comments.
 - NS to C-1
- N.2 SLUP-21-1244886 2021-2638/18-100-04-019
District 02 Super District 06
3795 North Druid Hills Road, Decatur, GA 30033
Acres: 1.04
- Please review general comments.
 - SLUP to allow drive through facility through in Town Center Character area.
- N.3 Z-21-1244892 2021-2640/12-253-03-002
District 03 Super District 07
5035 Flakes Mills Road, Ellenwood, GA 30294
Acres: 27
- Septic system installed on several surrounding properties in the past.
 - Please review general comments.
 - R-100 to R-60
- N.4 Z-21-1244893 2021-2641/18-095-03-005, 18-095-03-006, 18-095-03-008, 18-095-03-009, 18-095-03-090, 18-095-03-094
District 04 Super District 06
3943 Norman Road, Stone Mountain, GA 30083
Acres: 35
- Septic system installed on several surrounding properties in the past.
 - Please review general comments.
 - R-85 to RSM
- N.5 SLUP-21-1244895 2021-2641/15-137-03-028
District 03 Super Districts 06
2445 Candler Road, Decatur, GA 30032
Acres: 0.3
- Dental Building at time septic installed on 12/4/1962.
 - Please review general comments.
 - SLUP to Housing Facility



Board of Health

N.6 SLUP-21-1244899 2021/2643/15-084-05-068
District 03 Super District 06
3008 Rollingwood Lane, Atlanta, GA 30316
Acres: 0.35
- Septic system installed 8/19/1960.
- Please review general comments.

N.7 TA-21-1244945 2021-2644
Districts 03 & 05 Super District 07
- Please review general comments.

N.8 TA-21-1244999 2021-2645
Districts 03 & 05 Super District 07
- Please review general comments.

**DeKalb County School District
Development Review Comments**

Analysis Date: 6/11/2021

Submitted to: DeKalb County

Case #: Z-21-1244883

Parcel #: 18-095-03-005/-006/-008/-009/-090/-094

Name of Development: Hugh Spivey Lake
Location: 3943 Norman Road

Description: Large development with single-family attached and detached homes

Impact of Development: When fully constructed, this development would be expected to generate 91 students: 10 at Jolly Elementary School, 12 at Freedom Middle School, 16 at Clarkston High School, 29 at other DCSD schools, and 24 at private school. Jolly ES and Clarkston HS are already over capacity and new students from this development may require additional portable classrooms.

Current Condition of Schools	Jolly Elementary School	Freedom Middle School	Clarkston High School	Other DCSD Schools	Private Schools	Total
Capacity	712	1,251	1,190			
Portables	3	0	16			
Enrollment (Fcast. Oct. 2021)	730	1,116	1,513			
Seats Available	-18	135	-323			
Utilization (%)	102.5%	89.2%	127.1%			
New students from development	10	12	16	29	24	91
New Enrollment	740	1,128	1,529			
New Seats Available	-28	123	-339			
New Utilization	103.9%	90.2%	128.5%			

Yield Rates	Attend Home School	Attend other DCSD School	Private School	Total
Elementary	0.0457	0.0984	0.1034	0.0825
Middle	0.0507	0.0138	0.0000	0.0215
High	0.0708	0.0173	0.0000	0.0294
Total	0.0558	0.0432	0.0345	0.0445
Student Calculations				
Proposed Units	228			
Unit Type	Mixed			
Cluster	Clarkston High School			
Units x Yield	Attend Home School	Attend other DCSD School	Private School	Total
Elementary	10.43	22.44	23.58	56.45
Middle	11.56	3.14	0.00	14.70
High	16.15	3.94	0.00	20.09
Total	38.14	29.52	23.58	91.24
Anticipated Students	Attend Home School	Attend other DCSD School	Private School	Total
Jolly Elementary School	10	22	24	56
Freedom Middle School	12	3	0	15
Clarkston High School	16	4	0	20
Total	38	29	24	91

N-4



DEKALB COUNTY GOVERNMENT
PLANNING DEPARTMENT
DISTRIBUTION FORM

**NOTE: PLEASE RETURN ALL COMMENTS VIA EMAIL OR FAX TO EXPEDITE THE PROCESS TO
MICHELLE ALEXANDER mmalexander@dekalbcountyga.gov AND/OR LASONDRA HILL
lahill@dekalbcountyga.gov**

**COMMENTS FORM:
PUBLIC WORKS TRAFFIC ENGINEERING**

Case No.: Z-21-1244893 Parcel I.D. #: 18-095-03-005

Address: 3943
NORMAN Rd
STN. MTN. GO

Adjacent Roadway (s):

(classification) (classification)

Capacity (TPD) _____	Capacity (TPD) _____
Latest Count (TPD) _____	Latest Count (TPD) _____
Hourly Capacity (VPH) _____	Hourly Capacity (VPH) _____
Peak Hour. Volume (VPH) _____	Peak Hour. Volume (VPH) _____
Existing number of traffic lanes _____	Existing number of traffic lanes _____
Existing right of way width _____	Existing right of way width _____
Proposed number of traffic lanes _____	Proposed number of traffic lanes _____
Proposed right of way width _____	Proposed right of way width _____

Please provide additional information relating to the following statement.

According to studies conducted by the Institute of Traffic Engineers (ITE) 6/7TH Edition (whichever is applicable), churches generate an average of fifteen (15) vehicle trip end (VTE) per 1, 000 square feet of floor area, with an eight (8%) percent peak hour factor. Based on the above formula, the _____ square foot place of worship building would generate _____ vehicle trip ends, with approximately _____ peak hour vehicle trip ends.

Single Family residence, on the other hand, would generate ten (10) VTE's per day per dwelling unit, with a ten (10%) percent peak hour factor. Based on the above referenced formula, the _____ (Single Family Residential) District designation which allows a maximum of _____ units per acres, and the given fact that the project site is approximately _____ acres in land area, _____ daily vehicle trip end, and _____ peak hour vehicle trip end would be generated with residential development of the parcel.

COMMENTS:

Field and plans reviewed. Found nothing that would disrupt traffic flow.

Signature: [Handwritten Signature]

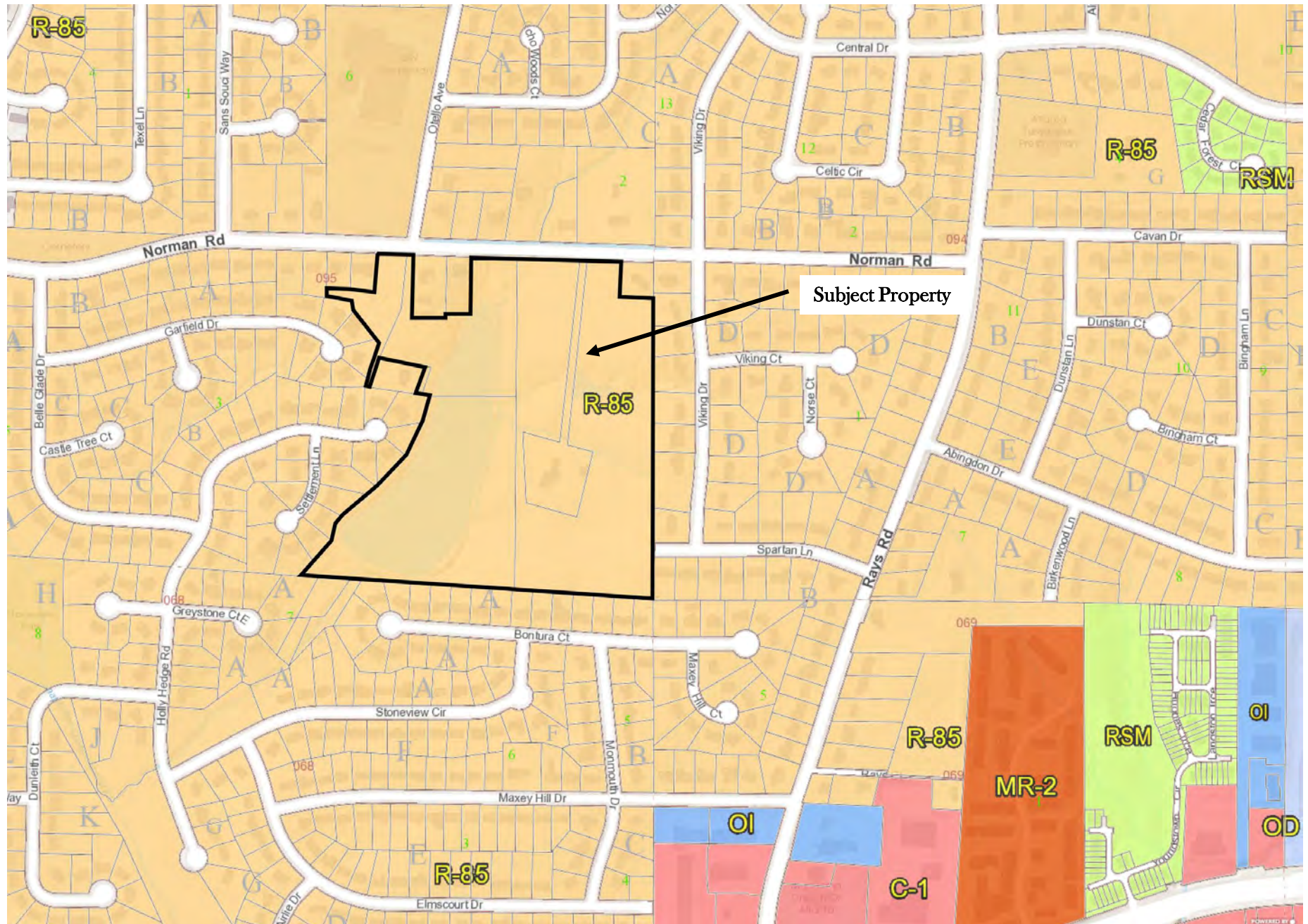

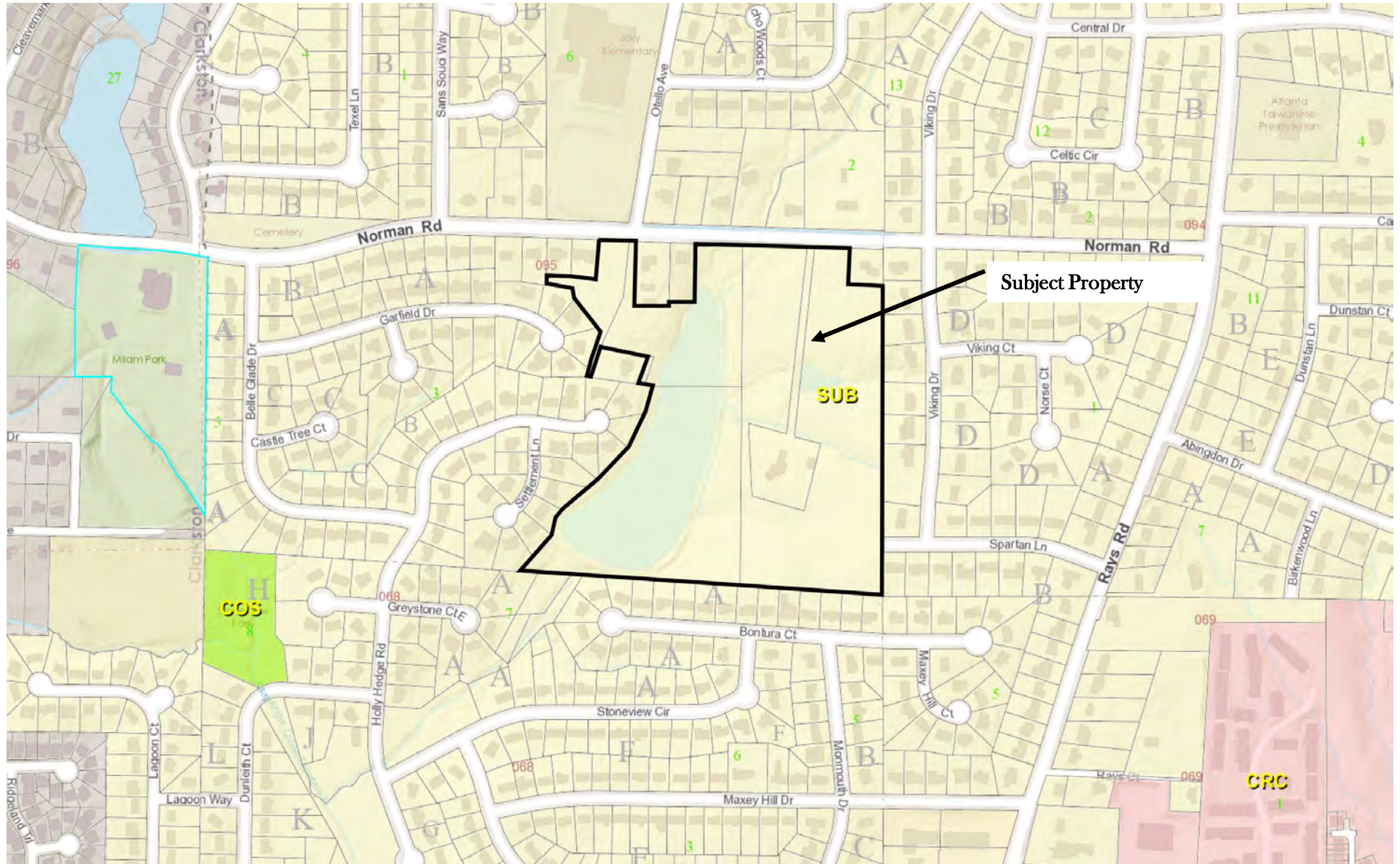



Subject Property



SITE PLAN LEGEND		PROJECT INFO	
[Orange Box]	BUILDING - 1 BEDROOM	UNITS	120
[Red Box]	BUILDING - 2 BEDROOM	1 BEDROOM HOMES	6
[Light Orange Box]	BUILDING - 3 BEDROOM	2 BEDROOM HOMES	24
[Light Red Box]	BUILDING - 3 BEDROOM	3 BEDROOM HOMES	42
[Light Orange Box]	BUILDING - TOWNHOUSE	TOWNHOUSE HOMES	24
[Blue Box]	BUILDING - COMMUNITY USE	TOTAL HOMES	100
[Green Box]	PORCH		
[Light Green Box]	NEW SIDEWALK		
[Light Green Box]	NATURAL WALKING PATH		
[Light Green Box]	PLAZA		
[Light Green Box]	NEW LANDSCAPE		
[Light Green Box]	GETTAGE COURT		
[Light Green Box]	100 YEAR FLOOD PLAN		
[Light Green Box]	STREAM BUFFER		



HIGH SPIVEY LAKE



1" = 40'-0"
SITE PLAN



DeKalb County Department of Planning & Sustainability

Michael L. Thurmond
Chief Executive Officer

Andrew A. Baker, AICP
Director



APPLICATION TO AMEND OFFICIAL ZONING MAP
OF DEKALB COUNTY, GEORGIA

Z/CZ No.
Filing Fee:
Date Received:
Application No.:

Applicant: Alderwood Capital, Inc d/b/a Mosaic Communities c/o Battle Law, P.C. E-Mail: mlb@battlelawpc.com
Applicant Mailing Address: One West Court Sq, Suite 750 Decatur, GA 30030
Applicant Phone: 404-601-7616 Fax: 404-745-0045

Owner(s): See Exhibit "A" E-Mail:
(If more than one owner, attach as Exhibit "A")

Owner's Mailing Address:

Owner(s) Phone: Fax:

Address/Location of Subject Property: 3943, 4039, 4069, 4021, 4083, and 4029 Norman Road, Stone Mountain, GA 30083

District(s): 18 Land Lot(s): 095 Block: 03 Parcel(s): 005, 006, 008, 009, 090, 094

Acreage: 34.88 34.93 Commission District(s): 4 & 6

Present Zoning Category: R-85 Proposed Zoning Category: RSM

Present Land Use Category: SUB

PLEASE READ THE FOLLOWING BEFORE SIGNING

This form must be completed in its entirety before the Planning Department accepts it. It must include the attachments and filing fees identified on the attachments. An application, which lacks any of the required attachments, shall be determined as incomplete and shall not be accepted.

Disclosure of Campaign Contributions

In accordance with the Conflict of Interest in Zoning Act, O.C.G.A., Chapter 36-67A, the following questions must be answered:

Have you the applicant made \$250 or more in campaign contributions to a local government official within two years immediately preceding the filing of this application? Yes No

If the answer is yes, you must file a disclosure report with the governing authority of DeKalb County showing the name and official position of the local government official to whom the campaign contribution was made.

- 2. The dollar amount and description of each campaign contribution made during the two years immediately preceding the filing of this application and the date of each such contribution.

The disclosure must be filed within 10 days after the application is first filed and must be submitted to the P.E.O. and the Board of Commissioners, DeKalb County, 1300 Commerce Drive, Decatur, Ga. 30030.

Signature of Notary: Michael D O'Loughlin
NOTARY

Signature of Applicant: [Signature] 4/28/21
SIGNATURE OF APPLICANT / DATE

Check One: Owner Agent X

OFFICIAL SEAL
MICHAEAL D O'LOUGHLIN
NOTARY PUBLIC - STATE OF ILLINOIS
MY COMMISSION EXPIRES 02/04/2021



DeKalb County Department of Planning & Sustainability

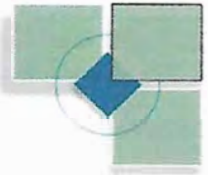

Michael L. Thurmond
Chief Executive Officer

Andrew A. Baker, AICP
Director

APPLICATION TO AMEND OFFICIAL ZONING MAP OF DEKALB COUNTY, GEORGIA

Z/CZ No. _____

Filing Fee: _____

Date Received: _____ Application No.: _____

Applicant: Alderwood Capital, Inc d/b/a Mosaic Communities c/o Battle Law, P.C. E-Mail: mlb@battlelawpc.com

Applicant Mailing Address: One West Court Sq. Suite 750 Decatur, GA 30030

Applicant Phone: 404-601-7616 Fax: 404-745-0045

Owner(s): See Exhibit "A" E-Mail: _____
(If more than one owner, attach as Exhibit "A")

Owner's Mailing Address: _____

Owner(s) Phone: _____ Fax: _____

Address/Location of Subject Property: 3943, 4039, 4069, 4021, 4083, and 4029 Norman Road, Stone Mountain, GA 30083

District(s): 18 Land Lot(s): 095 Block: 03 Parcel(s): 005, 006, 008, 009, 090, 094

Acreage: 34.88 34.93 Commission District(s): 4 & 6

Present Zoning Category: R-85 Proposed Zoning Category: RSM

Present Land Use Category: SUB

PLEASE READ THE FOLLOWING BEFORE SIGNING

This form must be completed in its entirety before the Planning Department accepts it. It must include the attachments and filing fees identified on the attachments. An application, which lacks any of the required attachments, shall be determined as incomplete and shall not be accepted.

Disclosure of Campaign Contributions

In accordance with the Conflict of Interest in Zoning Act, O.C.G.A., Chapter 36-67A, the following questions must be answered:

Have you the applicant made \$250 or more in campaign contributions to a local government official within two years immediately preceding the filing of this application? _____ Yes X No

If the answer is yes, you must file a disclosure report with the governing authority of DeKalb County showing the name and official position of the local government official to whom the campaign contribution was made.

2. The dollar amount and description of each campaign contribution made during the two years immediately preceding the filing of this application and the date of each such contribution.

The disclosure must be filed within 10 days after the application is first filed and must be submitted to the C.E.O. and the Board of Commissioners, DeKalb County, 1300 Commerce Drive, Decatur, Ga. 30030.

Michael D O'Loughlin
NOTARY

Andrew A Baker 4/28/21
SIGNATURE OF APPLICANT / DATE

Check One: Owner _____ Agent X



330 West Ponce de Leon Avenue - Suites 100-500 - Decatur, Georgia - 30030
404.371.2155 - [Planning Fax] (404) 371-4556 [Development Fax] (404) 371-3007
Web Address <http://www.dekalbcountyga.gov/planning>
Email Address: planninganddevelopment@dekalbcountyga.gov

Exhibit "A", Property Owner Signatures

Hugh Bennett Spivey, Jr.
36444 Dog Leg Court
Frankford, DE 19945
202-297-1025
Bennett.spivey@gmail.com

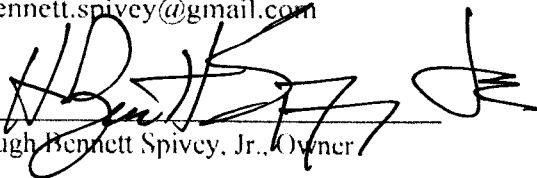

Hugh Bennett Spivey, Jr., Owner

Kay Spivey Sims
349 Nunally Farm Road
Monroe, GA 30655
770-20708020
simsrad@gmail.com

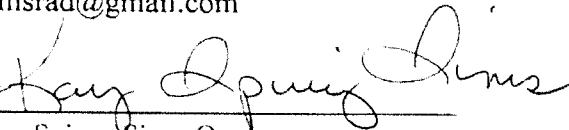

Kay Spivey Sims, Owner

Harry Stephen Spivey
339 Nunally Farm Road
Monroe, GA 30655
404-234-8835
scmspivey@windstream.net

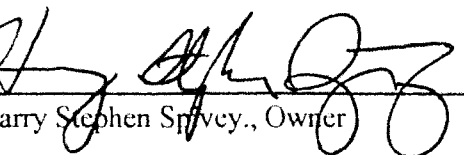

Harry Stephen Spivey, Owner



DeKalb County

404 371 2155 (6)
404 371 4556 (1)
DeKalb County, GA

Clark Harrison Building
330 W. Ponce de Leon Ave.
Decatur, GA 30030

Chief Executive Officer
Michael Thurmond

DEPARTMENT OF PLANNING & SUSTAINABILITY

Director
Andrew A. Baker, AICP

REZONE APPLICATION AUTHORIZATION

Completion of this form is required if the individual making the request is not the owner of the property.

DATE: 4/28/2021

CHECK TYPE OF APPLICATION:

- LAND USE PLAN
- REZONE
- MINOR MODIFICATION

TO WHOM IT MAY CONCERN:

(I) (WE), Hugh Bennett Spivey, Jr., Kay Spivey Sims, and Harry Stephen Spivey

(Name of owner(s))

being (owner)/(owners) of the property described below or attached hereby delegate

authority to Alderwood Capital Inc. c/o Battle Law, P.C.

(Name of Applicant or Agent Representing Owner)

to file an application on (my) / (our) behalf.

Jane West Tribbitt

Notary Public

Hugh Bennett Spivey, Jr.

Hugh Bennett Spivey, Jr., Owner

Jane S. Walker

Notary Public

Kay Spivey Sims

Kay Spivey Sims, Owner

Jane S. Walker

Notary Public

Harry Stephen Spivey

Harry Stephen Spivey, Owner

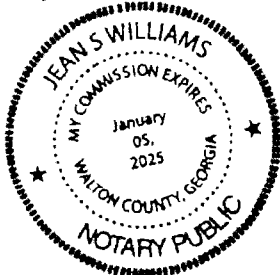

JANE WEST TRIBBITT
NOTARY PUBLIC
STATE OF DELAWARE
My Commission Expires 02-01-2022

Chief Executive Officer
Michael Thurmond

DEPARTMENT OF PLANNING & SUSTAINABILITY

Director
Andrew A. Baker, AICP

PRE-APPLICATION FORM
REZONE, SPECIAL LAND USE PERMIT, MODIFICATION, AND LAND USE
(Required prior to filing application: signed copy of this form must be submitted at filing)

Applicant Name: Nathan Williams Phone: 630-408-2875 Email: ntwilliams@gmail.com

Property Address: 4069 Norman Road and others

Tax Parcel ID: 18 095 03 005 18 095 03 006 18 095 03 008 18 095 03 009 18 095 03 090 18 095 03 094

Comm. District(s): 4 & 6 Acreage: 34.88 acres

Existing Use: Vacant land and vacant residential structure

Proposed Use Cottage-scale single-family detached and attached homes on smaller lots

Supplemental Regs: NA Overlay District: NA DRI: No based on applicant indicating estimated number of residential units will be 245. This should be verified.

Rezoning: Yes No

Existing Zoning: R-85 Proposed Zoning: RSM Square Footage/Number of Units: 245 (estimated)

Rezoning Request: Cottage scale single-family detached and attached homes on similar lots

Land Use Plan Amendment: Yes No

Existing Land Use: NA Proposed Land Use: NA Consistent Inconsistent

Special Land Use Permit: Yes No Article Number(s) 27-

Special Land Use Request(s) _____

Major Modification:

Existing Case Number(s): NA

Condition(s) to be modified: _____

DEPARTMENT OF PLANNING & SUSTAINABILITY

WHAT TO KNOW BEFORE YOU FILE YOUR APPLICATION

Pre-submittal Community Meeting: Review Calendar Dates: PC: 05/04/21 BOC:
05/27/21 Letter of Intent: Impact Analysis: Owner Authorization(s): Campaign
Disclosure: Zoning Conditions: Community Council Meeting: Public
Notice, Signs: Tree Survey, Conservation: Land Disturbance Permit (LDP):
 Sketch Plat: Bldg. Permits: Fire Inspection: Business
License: State License: _____ Lighting Plan: Tent Permit: Submittal

Format: NO STAPLES, NO BINDERS PLEASE

Deadline to host pre-community meeting 2/24/21

Filing Deadline 2/25/21

Review of Site Plan

Density: 7 units per acre _____ Density Bonuses: Will require provision of density bonus elements per
Article 2 and 5 of zoning ordinance _____ Mix of Uses: Open Space: Enhanced
Open Space: Setbacks: front sides side corner rear _____ Lot Size:
 Frontage: Street Widths: Landscape Strips:
Buffers: Parking Lot Landscaping: Parking - Auto: Parking - Bicycle:
 Screening: Streetscapes: Sidewalks: Fencing/Walls: _____
Bldg. Height: Bldg. Orientation: Bldg. Separation: _____ Bldg. Materials: Roofs:
_____ Fenestration: _____ Façade Design: _____ Garages: _____ Pedestrian Plan: _____ Perimeter
Landscape Strip: _____

Possible Variances: Significant floodplain on property may necessitate variances. No detailed site plan
provided. _____

Comments: Concept bubble plan provided, but no detailed plan showing specific number and location of specific types of
residential units with detailed dimensions was provided. Must demonstrate how proposed RSM zoning and development is
consistent and compatible with zoning and development pattern of surrounding area. Applicant indicates that this property is

DEPARTMENT OF PLANNING & SUSTAINABILITY

uniquely suited for RSM cluster development due to its natural community assets including Lake Spivey and an abundance of mature trees, and that the proposed development will include a community garden, walking trails, and preservation of a large amount of trees. The large amount of floodplain on the property may impact buildability. Proposed community garden must comply with Supplemental Regulations of zoning ordinance. The applicant indicated that community events may be desired in the future to foster sense of community in the project but no specific information was given. Proposed community events may or may not be allowed depending on zoning ordinance requirements. Proposed density requires provision of density bonus elements in Article 2 and 5 of zoning ordinance. Single-family detached, single-family attached, two-family dwellings, and three-family dwellings are allowed in RSM zoning, but multi-family dwellings are not allowed. If fee-simple lots are proposed they must comply with the perimeter lot compatibility requirements of Article 5 of the zoning ordinance. Street trees, sidewalks, street lights and landscape strips will be required along frontage of existing roads and along all proposed internal streets. Applicant will provide more details about the specific types of residential land uses and proposed building setbacks, building height, building material, open space, etc when a detailed site plan is provided with the submittal of a rezoning application. Traffic Impact Study will be required by the Zoning Ordinance. Please verify that no DRI is required.

Planner: John Reid Date 01/15/2021

Filing Fees

REZONING:	RE, RLG, R-100, R-85, R-75, R-60, MHP, RSM, MR-1	\$500.00
	RNC, MR-2, HR-1, HR-2, HR-3, MU-1, MU-2, MU-3, MU-4, MU-5	\$750.00
	OI, OD, OIT, NS, C1, C2, M, M2	\$750.00
LAND USE MAP AMENDMENT		\$500.00
SPECIAL LAND USE PERMIT		\$400.00

Pre-Submittal Community Meetings

- The first community meeting was held February 15, 2021 at 6pm via Zoom. Please find the notice sent out to community members attached to this application and a recording on the USB drive submitted along with the application. A mailing list for these applications is also attached.
- At this meeting, a smaller group of representatives was established to have additional discussion with the Applicant. This group met with the Applicant on April 22nd at 6pm via Zoom. Those included in the small group include:
 - There was another meeting for the entire community held on April 28th at 6:30pm via Zoom. Please find the notice sent out to the community members attached to this application, along with the registration list of who attended.

January 28, 2021

RE: A Proposed Rezoning Project at 3943, 4039, 4083, 4069, 4021 and 4029 Norman Road,
Stone Mountain, Georgia 30083

Dear Property Owner:

We would like for you to join our Zoom Video Meeting Monday, February 15, 2021 from 6:00pm – 7:00pm to discuss the proposed rezoning of the properties located at 3943, 4039, 4083, 4069, 4021 and 4029 Norman Road, Stone Mountain, Georgia 30083. My client, Mosaic Communities, in partnership with the Spivey family, which has owned the property for over 150 years, is seeking to rezone the property to allow for the development of a community-centric, walkable, conservation community comprised of single family attached and detached cottage homes. The Mosaic team is pursuing a collaborative approach to this development effort, and looks forward to hearing your feedback and suggestions.

Below are the meeting instructions. There are multiple ways for you to join the meeting, including via your computer, tablet, or cell phone, with or without video. If you are unable to make it, but would like to learn more, please contact our office at (404) 601-7616 ext. 2 or email us at bdc@battlelawpc.com and we'll send you a summary of the meeting.

You are invited to a Zoom meeting.

When: Feb 15, 2021 06:00 PM Eastern Time (US and Canada)

Register in advance for this meeting:

<https://us02web.zoom.us/join/register/tZIkduMtpzKvG9E5HRN-Yq4dlKS8bpmcT36Z>

After registering, you will receive a confirmation email containing information about joining the meeting.

Please contact our offices if you have any questions regarding the meeting.

Sincerely,

Michèle L. Battle



Zoom Step by Step Instructions

Go to <https://otago.zoom.us/join> and Enter the Meeting ID that you have been provided with in the appropriate field and click “Join” (the meeting ID will be a 9 digit or 10 digit number)

If joining from a mobile Device

If you are joining from a mobile device (Android smartphone/tablet, Apple iPhone/iPad) then it will simply prompt you to download the Zoom Cloud Meeting app from the App/Play Store.

If joining from a computer

When entering a Zoom meeting for the first time from a computer you may need to download a small application file. This process is easy to complete on all commonly used browsers. Google Chrome should automatically download the file.

Just before Entering the meeting you will be prompted to enter a display name. This name is simply to identify you in the meeting.

Join Audio via Computer

You will then be prompted how you wish to join your audio. If you wish to join audio via the telephone, follow the instructions further down, otherwise simply select Join Computer by Audio

Join Audio via Telephone

Dial in as using the number provided, however after entering the Meeting ID, you will be prompted to enter your Participant ID/Password. Simply enter this number followed by # and the video audio will then be synchronized.

Raising Your Hand

As the non-speaker if you wish to ask a question or make a point during the meeting it’s good protocol to use the “Raise Hand” facility.

If the tool bar is not showing at the bottom of the Zoom window, place your cursor over the Zoom window so it appears and select the “Participants” icon.

A window listing other participants will appear, there is also a “Raise Hand” icon, click the icon to make it known to the Host that you would like to raise your hand.

If you wish to lower your hand, click the “Lower Hand” icon that will have replaced the “Raise Hand” icon.

Leave Meeting

To leave a meeting from Zoom on your desktop, select “End Meeting” then “Leave Meeting.”

459-Norman Rd _ Address Mailing List

Name	Address	City, State, Zip
ABASHA FITYA	417 ROCKBRIDGE TRL	STONE MOUNTAIN GA 30083
ABITEW AMBAW D.	938 SETTLEMENT LN	STONE MOUNTAIN GA 30083
ABRAHAM LEUL G	4018 BONTURA CT	STONE MOUNTAIN GA 30083
ALEMAYEHU YARED A	876 MONMOUTH DR	STONE MOUNTAIN GA 30083
ALEMU ADANE	3933 GARFIELD DR	STONE MOUNTAIN GA 30083
AMDE TSEHAY	4120 BONTURA CT	STONE MOUNTAIN GA 30083
AMIN MOHAMAD BABU KHAN NUR	3947 GREYSTONE CT E	STONE MOUNTAIN GA 30083
ANDREWS JANET	3975 GARFIELD DR	STONE MOUNTAIN GA 30083
ASRA LENGAR	3998 BONTURA CT	STONE MOUNTAIN GA 30083
AVERY DEBORAH	4255 OXFORD CROSSING DR	DECATUR GA 30034
BAF 2 LLC	5001 PLAZA ON THE LK STE 200	AUSTIN TX 78746
BARBEE MILTON K	3984 GARFIELD DR	STONE MOUNTAIN GA 30083
BENNETT ANDREA	942 NORSE CT	STONE MOUNTAIN GA 30083
BENVENUTI MICHAEL E	3942 GARFIELD DR	STONE MOUNTAIN GA 30083
BERLAT INVESTMENT HOLDING LLC	P O BOX 232	STONE MOUNTAIN GA 30086
BOTORO DESSIE	4140 VIKING CT	STONE MOUNTAIN GA 30083
BOWMAN JAMES H	928 SETTLEMENT LN	STONE MOUNTAIN GA 30083
BOYER DEON O	3987 BONTURA CT	STONE MOUNTAIN GA 30083
BRADLEY KARMYN D	921 SETTLEMENT LN	STONE MOUNTAIN GA 30083
BRODERICK FRANK W	964 VIKING DR	STONE MOUNTAIN GA 30083
BROOKS ERIN A	3964 STONEVIEW CIR	STONE MOUNTAIN GA 30083
BROWN TRACY L	3941 GREYSTONE CT E	STONE MOUNTAIN GA 30083
BYRD DAPHNE	937 HOLLY HEDGE RD	STONE MOUNTAIN GA 30083
CALVIN REO MANAGEMENT LLC	3760 SIXES RD STE 126	CANTON GA 30114
CHERKOSE HAILU	4138 NORMAN RD	STONE MOUNTAIN GA 30083
CHHETRI GURU	3121 MAYS CT	DECATUR GA 30033
CHHETRI HIRA	4038 NORMAN RD	STONE MOUNTAIN GA 30083
COBBETT ERIN A	4139 VIKING CT	STONE MOUNTAIN GA 30083
COLEMAN DEBORAH B	8519 RICHMOND AVE	ALEXANDRIA VA 22309
CORNELIUS JAMES L	4032 STONEVIEW CIR	STONE MOUNTAIN GA 30083
CROSBY JANICE M	4088 NORMAN RD	STONE MOUNTAIN GA 30083
DAMON SCOTT	4073 ECHO WOODS DR	CLARKSTON GA 30021

DASOUZA ARTHUR	3986 BONTURA CT	STONE MOUNTAIN GA 30083
DAVIES VIVIAN	1601 ALDER CT SE	ATLANTA GA 30317
DEBESA DANIEL	4026 BONTURA CT	STONE MOUNTAIN GA 30083
DEKALB BOARD OF EDUCATION	1701 MOUNTAIN INDUSTRIAL BLVD	STONE MOUNTAIN GA 30083
DESALEGN MERSHA M	4122 SPARTAN LN	STONE MOUNTAIN GA 30083
DO TUAN MANH	3936 GARFIELD DR	STONE MOUNTAIN GA 30083
DOKAMO MISGANU H	4032 BONTURA CT	STONE MOUNTAIN GA 30083
EDWARDS ANITA G	976 VIKING DR	STONE MOUNTAIN GA 30083
EDWARDS FREDERICK	916 SETTLEMENT LN	STONE MOUNTAIN GA 30083
EDWARDS JUDY YOLANDA	4004 STONEVIEW CIR	STONE MOUNTAIN GA 30083
EDWARDS MARY KATHERINE	975 HOLLY HEDGE RD	STONE MOUNTAIN GA 30083
ELLIOTT JEAN	3999 BONTURA CT	STONE MOUNTAIN GA 30083
FABIAN FRANCES IONE	3983 NORMAN RD	STONE MOUNTAIN GA 30083
FALCO JOHN	4051 ECHO WOODS	CLARKSTON GA 30021
FALLS ZACK	3992 BONTURA CT	ATLANTA GA 30345
FARLEY DWAYNE E	4261 ANTELOPE LN	SNELLVILLE GA 30039
FAZACKERLEY ANDREW	1010 VIKING DR	STONE MOUNTAIN GA 30083
FERRIN REID P	3956 GREYSTONE CT E	STONE MOUNTAIN GA 30083
FORTNER LINDA CONNELLY	933 VIKING DR	STONE MOUNTAIN GA 30083
FOSTER TINEY	3943 GARFIELD DR	STONE MOUNTAIN GA 30083
FRAZIER CHRISTINE E	941 VIKING DR	STONE MOUNTAIN GA 30083
FRENCH ROBERT	968 HOLLY HEDGE RD	STONE MOUNTAIN GA 30083
FYR SFR BORROWER LLC	3505 KOGER BLVD STE 400	DULUTH GA 30096
GAVINS SONIA C	862 MAXEY HILL CT	STONE MOUNTAIN GA 30083
GEBREMEDHIN GIDEY	P O BOX 1214	CLARKSTON GA 30021
GEE RONNIE	877 MONMOUTH DR	STONE MOUNTAIN GA 30083
GHIDEY YEMANE	855 MONMOUTH DR	STONE MOUNTAIN GA 30083
GORNSTEIN JOAN	4078 NORMAN RD	STONE MOUNTAIN GA 30083
GREER THOMAS STIRLING	4147 NORMAN RD NW	STONE MOUNTAIN GA 30083
GUERRA JOEL ED	4016 STONEVIEW CIR	STONE MOUNTAIN GA 30083
GURUNG PAL M	4024 STONEVIEW CIR	STONE MOUNTAIN GA 30083
GUZMAN WILLEHADO	3993 BONTURA CT	STONE MOUNTAIN GA 30083
HADERA ELSA ZEWDU	1019 VIKING DR	STONE MOUNTAIN GA 30083
HANKTON JOYCE MARIE	1097 COTTON OAK DR	LAWRENCEVILLE GA 30045
HAQU AMONUL	4064 STONEVIEW CIR	STONE MOUNTAIN GA 30083

HASSEN JEMAL S	866 MONMOUTH DR	STONE MOUNTAIN GA 30083
HAYNES CHRISTOPHER G	992 BAY POINTE WAY SW	LILBURN GA 30047
HIGHSMITH JOHN HOLMES	4067 ECHO WOODS DR	CLARKSTON GA 30021
HRITZ STEPHEN J	3950 GARFIELD DR	STONE MOUNTAIN GA 30083
HUSSEINI NOORULHAQ	4052 BONTURA CT	STONE MOUNTAIN GA 30083
HUSSEINI NOORULHAQ S	4049 BONTURA CT	STONE MOUNTAIN GA 30083
IRBY SUSAN L W	4023 NORMAN RD	STONE MOUNTAIN GA 30083
JACKSON JANA E G	982 HOLLY HEDGE RD	STONE MOUNTAIN GA 30083
JAMA SAID HASSAN	4146 NORMAN RD	STONE MOUNTAIN GA 30083
JENKINS ALEX LIVING TRUST	89 2ND AVE SE	ATLANTA GA 30317
JONES ELLIOT JR	4019 NORMAN RD	STONE MOUNTAIN GA 30083
KAMRUZZAMAN MOHAMMAD	3991 NORMAN RD	STONE MOUNTAIN GA 30083
KHOWAJA ABDUL KARIM	927 SETTLEMENT LN	STONE MOUNTAIN GA 30083
KIM ANDREW J	916 HOLLY HEDGE RD	STONE MOUNTAIN GA 30083
KING BATTLE JHUMIKEA T	949 VIKING DR	STONE MOUNTAIN GA 30083
KING DAWN M	975 VIKING DR	STONE MOUNTAIN GA 30083
KNOWLES CHRISTOPHER	4117 SPARTAN LN	STONE MOUNTAIN GA 30083
LAM TAN NHAN	4125 SPARTAN LN	STONE MOUNTAIN GA 30083
LAMB SANDRA HER ESTATE PERS RE	P O BOX 13513	FLINT MI 48501
LAMBMO DEBEBE T	4072 BONTURA CT	STONE MOUNTAIN GA 30083
LARRY J R	4027 BONTURA CT	STONE MOUNTAIN GA 30083
LE NGU VAN	4043 ECHO WOODS DR	CLARKSTON GA 30021
LE NGUYET YEN THI	1027 VIKING DR	STONE MOUNTAIN GA 30083
LEWIS GERALDINE H	950 NORSE CT	STONE MOUNTAIN GA 30083
LEWIS JACQUELINE L	958 NORSE CT	STONE MOUNTAIN GA 30083
LI BOI	3951 NORMAN RD	STONE MOUNTAIN GA 30083
LIN JASPER	915 SETTLEMENT LN	STONE MOUNTAIN GA 30083
LITTLE BUTCH	4000 STONEVIEW CIR	STONE MOUNTAIN GA 30083
LONGMORE HUGH T	4007 BONTURA CT	STONE MOUNTAIN GA 30083
LOPEZ DELCID NORMA C	4012 BONTURA CT	STONE MOUNTAIN GA 30083
MADDOX HENRY B	986 VIKING DR	STONE MOUNTAIN GA 30083
MADEBO ELIAS W	873 HOLLY HEDGE RD	STONE MOUNTAIN GA 30083
MAHGOUB ALI S	5910 MASTERS CLUB DR	SUWANEE GA 30024
MAJHI BUDDHI	3946 GREYSTONE CT E	STONE MOUNTAIN GA 30083
MARKITON GEOFFREY M	4104 SPARTAN LN	STONE MOUNTAIN GA 30083

MASON JOHN D	4030 NORMAN RD	STONE MOUNTAIN GA 30083
MATTHEWS DAVID TIMOTHY SR	960 GARFIELD CT	STONE MOUNTAIN GA 30083
MATTOX PAIGE	3959 GARFIELD DR	STONE MOUNTAIN GA 30083
MCPHEE BLONEVA M	915 HOLLY HEDGE RD	STONE MOUNTAIN GA 30083
MEZA CLETO ADRIANO	908 SETTLEMENT LN	STONE MOUNTAIN GA 30083
MID TOWN PARTNERS LLC	2701 WINDEMERE DR	VALDOSTA GA 31602
MIGNOTT OSWALD	4096 BONTURA CT	STONE MOUNTAIN GA 30083
MILLER JAMES D	4112 BONTURA CT	STONE MOUNTAIN GA 30083
MILLER JAMES RICHARD JR	3928 GREYSTONE CT E	STONE MOUNTAIN GA 30083
MINER KEVIN JOSHUA	3952 GREYSTONE CT E	STONE MOUNTAIN GA 30083
MINER KEVIN JOSHUA	3952 GREYSTONE CT	STONE MOUNTAIN GA 30083
MOHAMAD NOJUMA	4043 STONEVIEW CIR	STONE MOUNTAIN GA 30083
MORRIS GWENNETTA L	4087 SPARTAN LN	STONE MOUNTAIN GA 30083
MORRISON-LEE CYNTHIA	3934 GREYSTONE CT E	STONE MOUNTAIN GA 30083
MOSLEY GREGORY	4006 BONTURA CT	STONE MOUNTAIN GA 30083
MURRAY GLENN E	974 HOLLY HEDGE RD	STONE MOUNTAIN GA 30083
MWENDANABABO LUBUNGA	4101 SPARTAN LN	STONE MOUNTAIN GA 30083
NGUYEN AN T	1011 VIKING DR	STONE MOUNTAIN GA 30083
NGUYEN HAO H	856 MAXEY HILL CT	STONE MOUNTAIN GA 30083
NGUYEN HUNG DUC	3940 GREYSTONE CT E	STONE MOUNTAIN GA 30083
NGUYEN THU THAO	760 ANNA LN	ALPHARETTA GA 30004
NGUYEN TUONG BA	4035 ECHO WOODS DR	CLARKSTON GA 30021
NOUKAYSONE MALAYVANH	3971 SANS SOUCI CT	CLARKSTON GA 30021
NUREN FATIMA H	951 HOLLY HEDGE RD	STONE MOUNTAIN GA 30083
OVERBY DEBRA ANN	3970 GARFIELD DR	STONE MOUNTAIN GA 30083
PATTON MARTHA A	911 SETTLEMENT LN	STONE MOUNTAIN GA 30083
PERI KEITH	4035 NORMAN RD	STONE MOUNTAIN GA 30083
PHAM HUNG D	901 HOLLY HEDGE RD	STONE MOUNTAIN GA 30083
PHILIPPI WESTLEY J	4037 STONEVIEW CIR	STONE MOUNTAIN GA 30083
PHILLIPS JANICE ANN	990 HOLLY HEDGE RD	STONE MOUNTAIN GA 30083
PITTMAN RONNIE E	4027 ECHO WOODS DR	CLARKSTON GA 30021
POWELL OONA MAUD	996 HOLLY HEDGE RD	STONE MOUNTAIN GA 30083
PRADHAN GANGA M	921 HOLLY HEDGE RD	STONE MOUNTAIN GA 30083
PU MA	4101 NORMAN RD	STONE MOUNTAIN GA 30083
QUACH MAN V	4059 ECHO WOODS DR	CLARKSTON GA 30021

RAMSEY MARY LOUISE	3986 STONEVIEW CIR	STONE MOUNTAIN GA 30083
RANDALL JAMES D	3990 NORMAN RD	STONE MOUNTAIN GA 30083
REIS STEPHEN	1034 VIKING DR	STONE MOUNTAIN GA 30083
RICKARD BARBARA A	4116 BONTURA CT	STONE MOUNTAIN GA 30083
RITZ STEPHEN J	989 HOLLY HEDGE RD	STONE MOUNTAIN GA 30083
ROONEY BRUCE N	3983 GARFIELD DR	STONE MOUNTAIN GA 30083
SABREE HAAZIM S	4046 BONTURA CT	STONE MOUNTAIN GA 30083
SADIKOVA GULNORA	4029 NORMAN RD	STONE MOUNTAIN GA 30083
SALIH-SINDY AMIN	4050 STONEVIEW CIR	STONE MOUNTAIN GA 30083
SANCHEZ DE VASQUEZ NUBIA I	3980 STONEVIEW CIR	STONE MOUNTAIN GA 30083
SAY LIN	954 HOLLY HEDGE RD	STONE MOUNTAIN GA 30083
SEBHAT TSIGE	4019 BONTURA CT	STONE MOUNTAIN GA 30083
SHEIKH ALI M	4093 SPARTAN LN	STONE MOUNTAIN GA 30083
SHIVER SOMMER LEEANN	4104 BONTURA CT	STONE MOUNTAIN GA 30083
SHUMAN PAUL G	3965 SANS SOUCI CT	CLARKSTON GA 30021
SIBLEY ANDREA L	3987 GARFIELD DR	STONE MOUNTAIN GA 30083
SIMON ELIJAH	985 HOLLY HEDGE RD	STONE MOUNTAIN GA 30083
SISAY MOGUS T	4038 BONTURA CT	STONE MOUNTAIN GA 30083
SMITH CARL V	3970 NORMAN RD	STONE MOUNTAIN GA 30083
SON TRI NGOC	944 VIKING DR	STONE MTN GA 30083
SOUDER VINNIE	4013 BONTURA CT	STONE MOUNTAIN GA 30083
SPANN BRUCE E	849 MONMOUTH DR	STONE MOUNTAIN GA 30083
SPARKS ROY ALLEN	4115 NORMAN RD	STONE MOUNTAIN GA 30083
SPARKS TERRY LEE	983 VIKING DR	STONE MOUNTAIN GA 30083
SPIVEY HUGH B	4069 NORMAN RD	STONE MOUNTAIN GA 30083
SPIVEY HUGH B SR	339 NUNNALLY FARM RD	MONROE GA 30655
SULTAN MOHAMMAD NASIM AMIR	3998 STONEVIEW CIR	STONE MOUNTAIN GA 30083
TAMANG YUBA R	909 HOLLY HEDGE RD	STONE MOUNTAIN GA 30083
TEKA TESFAYE ADDISU	1031 OTELLO AVE	CLARKSTON GA 30021
TEKESTE BELAY	925 VIKING DR	STONE MOUNTAIN GA 30083
THAWNG BIAK	876 BELLE GLADE DR	STONE MOUNTAIN GA 30083
THEPHRAVONG PRASITHKEUN	4139 NORMAN RD	STONE MOUNTAIN GA 30083
THOMAS SHIRLEY	3980 GARFIELD DR	STONE MOUNTAIN GA 30083
THOMPSON DAVID JAMES	3982 NORMAN RD	STONE MOUNTAIN GA 30083
THONG XUONG SUONG	948 HOLLY HEDGE RD	STONE MOUNTAIN GA 30083

TOLIFERRO PAYTON	934 VIKING DR	STONE MOUNTAIN GA 30083
TOWNES JENNIFER	4079 ECHO WOODS DR	CLARKSTON GA 30021
TRAN BAO QUYEN T	3959 NORMAN RD	STONE MOUNTAIN GA 30083
TSEGAYE GETACHEW	260 GALESBURG DR	LAWRENCEVILLE GA 30044
VEST TERESA L	4096 NORMAN RD	STONE MOUNTAIN GA 30083
VO CHINH VAN	3988 GARFIELD DR	STONE MOUNTAIN GA 30083
VOGT LEONARD LEO	861 MAXEY HILL CT	STONE MOUNTAIN GA 30083
VOYLES DIANE K	865 HOLLY HEDGE RD	STONE MOUNTAIN GA 30083
WALKER ZAKIYA	4129 NORMAN RD	STONE MOUNTAIN GA 30083
WALTER AUGUST GRAGE REVOCABL	954 VIKING DR	STONE MOUNTAIN GA 30083
WAMUKA ELIAS	4080 BONTURA CT	STONE MOUNTAIN GA 30083
WARREN ROY D CO INC	3984 STONEVIEW CIR	STONE MOUNTAIN GA 30083
WARSAME SADO	2697 IMPERIAL HILLS DR	TUCKER GA 30084
WEETMAN SUSIE	905 SETTLEMENT LN	STONE MOUNTAIN GA 30083
WELDERMARIAM ABEBA	4089 BONTURA CT	STONE MOUNTAIN GA 30083
WELDU YOHANNES N	916 VIKING DR	STONE MOUNTAIN GA 30083
WEST CHARLES ROBERT III	903 SETTLEMENT LN	STONE MOUNTAIN GA 30083
WILKES THEODORE M JR	3933 GREYSTONE CT E	STONE MOUNTAIN GA 30083
WILLIAMS ESTELLE COLLINS	873 MAXEY HILL CT	STONE MOUNTAIN GA 30083
WINKLER ANDREA L	3975 NORMAN RD	STONE MOUNTAIN GA 30083
WOODLEY CYNTHIA D	1026 VIKING DR	STONE MOUNTAIN GA 30083
YEMER ENDALECH A	4114 SPARTAN LN	STONE MOUNTAIN GA 30083
YOO PETER H	3951 GARFIELD DR	STONE MOUNTAIN GA 30083
ZHENG JIAN JUN	962 HOLLY HEDGE RD	STONE MOUNTAIN GA 30083

April 22, 2021

RE: The Cottages at Spivey Lake Project

A Proposed Rezoning of 3943, 4039, 4083, 4069, 4021 and 4029 Norman Road, DeKalb County

Dear Resident:

We would like to invite you to join our Zoom Video Meeting on **Wednesday, April 28, 2021**, from 6:30 pm to 7:30 pm EST to discuss a proposed rezoning for the above-referenced property. My client, Mosaic Communities, in partnership with the Spivey family, which has owned the property for over 150 years, is seeking to rezone the 34.93 acre property to allow for the development of a community-centric, walkable, conservation community comprised of up to 230 cottage-style single family attached and detached homes.

Below are the meeting instructions. There are multiple ways for you to join the meeting, including via your computer, tablet, or cell phone, with or without video. If you are unable to make it, but would like to learn more, please contact our office at (404) 601-7616 ext. 2 or email us at bdc@battlelawpc.com and we'll send you a summary of the meeting.

Hi there,

You are invited to a Zoom meeting.

When: April 28, 2021 at 6:30 PM Eastern Time (US and Canada)

Register in advance for this meeting:

<https://otago.zoom.us/join>

Meeting ID: 823 0532 2191

Passcode: 217764

After registering, you will receive a confirmation email containing information about joining the meeting.

Please contact our offices if you have any questions regarding the meeting.

Sincerely,

Michele L. Battle

Michèle L. Battle



Zoom Step by Step Instructions

Go to <https://otago.zoom.us/join> and Enter the Meeting ID that you have been provided with in the appropriate field and click “Join” (the meeting ID will be a 9 digit or 10 digit number)

If joining from a mobile Device

If you are joining from a mobile device (Android smartphone/tablet, Apple iPhone/iPad) then it will simply prompt you to download the Zoom Cloud Meeting app from the App/Play Store.

If joining from a computer

When entering a Zoom meeting for the first time from a computer you may need to download a small application file. This process is easy to complete on all commonly used browsers. Google Chrome should automatically download the file.

Just before Entering the meeting you will be prompted to enter a display name. This name is simply to identify you in the meeting.

Join Audio via Computer

You will then be prompted how you wish to join your audio. If you wish to join audio via the telephone, follow the instructions further down, otherwise simply select Join Computer by Audio.

Join Audio via Telephone

Dial in using (646) 558-8656, after entering the Meeting ID, you will be prompted to enter your Participant ID/Password. Simply enter this number followed by # and the video audio will then be synchronized.

Raising Your Hand

As the non-speaker if you wish to ask a question or make a point during the meeting it’s good protocol to use the “Raise Hand” facility.

If the tool bar is not showing at the bottom of the Zoom window, place your cursor over the Zoom window so it appears and select the “Participants” icon.

A window listing other participants will appear, there is also a “Raise Hand” icon, click the icon to make it known to the Host that you would like to raise your hand.

If you wish to lower your hand, click the “Lower Hand” icon that will have replaced the “Raise Hand” icon.

Leave Meeting

To leave a meeting from Zoom on your desktop, select “End Meeting” then “Leave Meeting.”

459-Spivey Cottages sign in Sheet

First Name	Last Name	Email	Registration Time	Approval Status
Angela		mom25as@gmail.com	4/25/2021 16:25	approved
Lee French		inframan36207@yahoo.com	4/26/2021 22:30	approved
Joan	Wheeler	joanxher3stooges@gmail.com	4/26/2021 14:07	approved
Valerie	P.	wadeandvalerie@gmail.com	4/28/2021 18:34	approved
Davis	Moore	davis.a.moore@gmail.com	4/23/2021 7:08	approved
Fred	Edwards	uqobo@bellsouth.net	4/27/2021 12:04	approved
Victoria	Webb	vic@furiousdreams.com	4/28/2021 18:31	approved
Andrea	Bennett	andrea0599@gmail.com	4/28/2021 18:32	approved
Keith	Peri	keith@sellsatl.com	4/28/2021 18:34	approved
Gina	Sgro	ginasgro@gmail.com	4/28/2021 18:27	approved
Paul	Shuman	pgshuman@aol.com	4/22/2021 16:13	approved
JSUN		jsunbelw@gmail.com	4/28/2021 19:16	approved
Martha	Sparks	janesparks22@gmail.com	4/28/2021 15:24	approved
		mlb@battlelawpc.com	4/28/2021 18:28	approved
Audrey Gao		gaoxy0909@gmail.com	4/28/2021 18:43	approved
stephen		dasadhad@gmail.com	4/28/2021 18:29	approved
Paula	Chambers	champf@att.net	4/28/2021 18:32	approved
Ronald	Abercrombie	RABERCR@emory.edu	4/28/2021 14:06	approved
Samantha	Altfest	altfest.samantha@gmail.com	4/27/2021 11:21	approved
tracy		tracy.bishop@scrippstv.com	4/28/2021 18:51	approved
Walter	Grage	wagsr41@gmail.com	4/25/2021 11:08	approved
Susan Baker		shbaker@bellsouth.net	4/28/2021 18:16	approved
Connie Perry		cgnrperry@bellsouth.net	4/28/2021 18:26	approved
Galaxy S10e		cocooreo77@gmail.com	4/28/2021 18:39	approved
Dean Moore		deanmoore64@gmail.com	4/24/2021 8:53	approved
John	McGuinness	hopintolife@gmail.com	4/28/2021 13:18	approved
JANICE	CROSBY	janmdc@yahoo.com	4/22/2021 16:04	approved
ginny	matthews	matthewsvirginia@att.net	4/26/2021 19:17	approved
Jack	Logan	jackloganhomes@gmail.com	4/26/2021 23:12	approved
ann mccormack		mccorman@bellsouth.net	4/28/2021 18:31	approved
Batoya	Clements	bclcm21@msn.com	4/28/2021 18:56	approved
Alem		alem.giorgis@gmail.com	4/28/2021 19:56	approved

Nathan	Williams	nate@walkmosaic.com	4/28/2021 18:24	approved
Nicole	Keating	nkeating2003@yahoo.com	4/28/2021 18:31	approved
joan		jjkidd@comcast.net	4/28/2021 18:27	approved
cynthia	Woodley	woodley.cynthia@yahoo.com	4/28/2021 18:33	approved
David	Skretch	silvermartin28@msn.com	4/28/2021 17:34	approved
Angela Baldwin		abtv3@yahoo.com	4/28/2021 18:29	approved
Eric	Kronberg	ekronberg@kronbergua.com	4/28/2021 18:59	approved
Tony	Hall	tonyhall329@gmail.com	4/28/2021 18:28	approved
Karen	Gabrielson	kgabrielson@gsu.edu	4/28/2021 17:14	approved
MARGARET	SHUMAN	PMPSHUMAN@AOL.COM	4/22/2021 16:16	approved
Debbie	Lipscomb	cartamebdezine@gmail.com	4/27/2021 23:00	approved
Jacqueline	Harris	jaquilu958@gmail.com	4/27/2021 21:19	approved
Smilowitz		Sittingwithsharon@hotmail.com	4/26/2021 16:11	approved
Amina	Rasool	arasool@drghs.org	4/28/2021 18:47	approved
Eric Ketcham		info@d4dresidency.org	4/28/2021 18:24	approved
SEAN	WATERS	s.patrick.waters@gmail.com	4/28/2021 15:20	approved
gregory	mosley	stoneview411@gmail.com	4/28/2021 18:26	approved
Adane A		adaneatl@yahoo.com	4/28/2021 18:35	approved
Tracey	Harris	traceymharris@gmail.com	4/28/2021 18:53	approved
Stephen	Powell	ranger1979.sp@gmail.com	4/28/2021 12:08	approved
Susan	Williams	shwilliams314@yahoo.com	4/28/2021 18:46	approved
Danielle	Blumenthal	Dlb@battlelawpc.com	4/28/2021 18:27	approved
Karen	Grage	kegrage@aol.com	4/22/2021 13:47	approved
Vivian		ShonnaDavies@yahoo.com	4/28/2021 18:29	approved
Mark	Jernigan	MARKJERNIGAN@OUTLOOK.COM	4/28/2021 18:39	approved
Jan	Phillips	janphillips3@gmail.com	4/28/2021 12:24	approved
Brian Bollinger		bbollinger@insightsourcing.com	4/27/2021 7:25	approved
Julia Green		juleeza@yahoo.com	4/28/2021 17:31	approved
Bebe	Joyner	bebejoyner@gmail.com	4/28/2021 18:26	approved
Gregory	Aide	gregory.aide@gmail.com	4/26/2021 10:00	approved
Phyllis	Rooney	pirooney62@gmail.com	4/27/2021 7:15	approved
Armond	Lewis	ArmondLewis@hotmail.com	4/28/2021 17:55	approved
Mags Malone		magsmalone19@gmail.com	4/28/2021 19:07	approved
Anita	Edwards	anita@anitaedwards.com	4/28/2021 10:08	approved

Oona	Powell	oon0099@gmail.com	4/28/2021 12:10	approved
Cara OBrien		cobrien@kronbergua.com	4/28/2021 18:33	approved
Nate Williams		ntwilliams32@gmail.com	4/28/2021 18:30	approved
Stephen	Ritz	sritzphd@hotmail.com	4/28/2021 18:32	approved
Deidre	Burton	deidreburton@hotmail.com	4/25/2021 14:19	approved

First Name	Last Name	Email	Registratio	Approval Status
Angela		mom25as@	#####	approved
Lee French		inframan3@	#####	approved
Joan	Wheeler	joanxher3@	#####	approved
Valerie	P.	wadeandva@	#####	approved
Davis	Moore	davis.a.mo@	#####	approved
Fred	Edwards	uqobo@be	#####	approved
Victoria	Webb	vic@furiou	#####	approved
Andrea	Bennett	andrea059@	#####	approved
Keith	Peri	keith@sell@	#####	approved
Gina	Sgro	ginasgro@j	#####	approved
Paul	Shuman	pgshuman@	#####	approved
JSUN		jsunbelw@	#####	approved
Martha	Sparks	janesparks@	#####	approved
		mlb@battl@	#####	approved
Audrey Gao		gaoxy0909	#####	approved
stephen		dasadhad@	#####	approved
Paula	Chambers	champf@a	#####	approved
Ronald	Abercromb	RABERCR@	#####	approved
Samantha	Altfest	altfest.sam	#####	approved
tracy		tracy.bisho	#####	approved
Walter	Grage	wagsr41@j	#####	approved
Susan Baker		shbaker@t	#####	approved
Connie Perry		cgnrperry@	#####	approved
Galaxy S10e		cocooreo7@	#####	approved
Dean Moore		deanmoore@	#####	approved
John	McGuinnes	hopintolife	#####	approved
JANICE	CROSBY	janmdc@y@	#####	approved
ginny	matthews	matthewsv@	#####	approved
Jack	Logan	jackloganh@	#####	approved
ann mccormack		mccorman@	#####	approved
Batoya	Clements	bclcm21@	#####	approved
Alem		alem.giorgi	#####	approved
Nathan	Williams	nate@walk	#####	approved
Nicole	Keating	nkeating20	#####	approved
joan		jjkidd@con	#####	approved
cynthia	Woodley	woodley.cy	#####	approved
David	Skretch	silvermartin	#####	approved
Angela Baldwin		abtvc3@ya	#####	approved
Eric	Kronberg	ekronberg@	#####	approved
Tony	Hall	tonyhall32@	#####	approved
Karen	Gabrielson	kgabrielsor	#####	approved
MARGARET	SHUMAN	PMPSHUM	#####	approved
Debbie	Lipscomb	cartamebd	#####	approved
Jacqueline	Harris	jaquilu958@	#####	approved
Smilowitz		Sittingwith@	#####	approved
Amina	Rasool	arasool@d	#####	approved

Eric Ketcham		info@d4dr	#####	approved
SEAN	WATERS	s.patrick.w	#####	approved
gregory	mosley	stoneview4	#####	approved
Adane A		adaneatl@	#####	approved
Tracey	Harris	traceymhai	#####	approved
Stephen	Powell	ranger1979	#####	approved
Susan	Williams	shwilliams5	#####	approved
Danielle	Blumentha	Dlb@battle	#####	approved
Karen	Grage	kegrage@a	#####	approved
Vivian		ShonnaDav	#####	approved
Mark	Jernigan	MARKJERN	#####	approved
Jan	Phillips	janphillips3	#####	approved
Brian Bollinger		bbollinger@	#####	approved
Julia Green		juleeza@ya	#####	approved
Bebe	Joyner	bebejoyner	#####	approved
Gregory	Aide	gregory.aid	#####	approved
Phyllis	Rooney	pirooney62	#####	approved
Armond	Lewis	ArmondLev	#####	approved
Mags Malone		magsmalor	#####	approved
Anita	Edwards	anita@anit	#####	approved
Oona	Powell	oona0099@	#####	approved
Cara OBrien		cobrien@k	#####	approved
Nate Williams		ntwilliams5	#####	approved
Stephen	Ritz	sritzphd@f	#####	approved
Deidre	Burton	deidreburto	#####	approved

First Name	Last Name	Email	Registratio	Approval Status
Dean	Moore	deanmoore@	#####	approved
JANICE	CROSBY	janmdc@y	#####	approved
Michele	Battle	battlelawp	#####	approved
Phyllis	Rooney	pirooney62	#####	approved
Ann	McCormac	mccorman@	#####	approved
Nathan	Williams	nate@walk	#####	approved
Davis	Moore	davis.a.mo	#####	approved
Bob	Humphrey	linc396@b	#####	approved
Victoria	Webb	vic@furiou	#####	approved
Henry	Griesbach	hcabseirg@	#####	approved
Nate	Williams	ntwilliams@	#####	approved
Joe	Arrington	jarring55@	#####	approved
Danielle	Blumentha	Dlb@battle	#####	approved
		mlb@battl	#####	approved
joan	gornstein	jgornstein@	#####	approved

First Name	Last Name	Email	Registratio	Approval Status
Angela		mom25as@	#####	approved
Lee French		inframan3@	#####	approved
Joan	Wheeler	joanxher3@	#####	approved
Valerie	P.	wadeandva@	#####	approved
Davis	Moore	davis.a.mo@	#####	approved
Fred	Edwards	uqobo@be	#####	approved
Victoria	Webb	vic@furiou	#####	approved
Andrea	Bennett	andrea059@	#####	approved
Keith	Peri	keith@sell@	#####	approved
Gina	Sgro	ginasgro@j	#####	approved
Paul	Shuman	pgshuman@	#####	approved
JSUN		jsunbelw@	#####	approved
Martha	Sparks	janesparks@	#####	approved
		mlb@battl@	#####	approved
Audrey Gao		gaoxy0909	#####	approved
stephen		dasadhad@	#####	approved
Paula	Chambers	champf@a	#####	approved
Ronald	Abercromb	RABERCR@	#####	approved
Samantha	Altfest	altfest.sam	#####	approved
tracy		tracy.bisho	#####	approved
Walter	Grage	wagsr41@j	#####	approved
Susan Baker		shbaker@t	#####	approved
Connie Perry		cgnrperry@	#####	approved
Galaxy S10e		cocooreo7@	#####	approved
Dean Moore		deanmoore@	#####	approved
John	McGuinnes	hopintolife	#####	approved
JANICE	CROSBY	janmdc@y@	#####	approved
ginny	matthews	matthewsv	#####	approved
Jack	Logan	jacklogan@h	#####	approved
ann mccormack		mccorman@	#####	approved
Batoya	Clements	bclm21@	#####	approved
Alem		alem.giorgi	#####	approved
Nathan	Williams	nate@walk	#####	approved
Nicole	Keating	nkeating20	#####	approved
joan		jjkidd@con	#####	approved
cynthia	Woodley	woodley.cy	#####	approved
David	Skretch	silvermartin	#####	approved
Angela Baldwin		abtvc3@ya	#####	approved
Eric	Kronberg	ekronberg@	#####	approved
Tony	Hall	tonyhall32@	#####	approved
Karen	Gabrielson	kgabrielsor	#####	approved
MARGARET	SHUMAN	PMPSHUM	#####	approved
Debbie	Lipscomb	cartamebd	#####	approved
Jacqueline	Harris	jaquilu958@	#####	approved
Smilowitz		Sittingwith@	#####	approved
Amina	Rasool	arasool@d	#####	approved

LEGAL DESCRIPTION

THAT CERTAIN TRACT OR PARCEL OF LAND LYING AND BEING IN LAND LOT 95 OF THE 18TH DISTRICT, 2ND SECTION, DEKALB COUNTY, GEORGIA AND MORE PARTICULARLY DESCRIBED AS FOLLOWS:

BEGINNING AT THE POINT OF INTERSECTION OF LAND LOTS 68, 69, 94 AND 95 AT A 1/2" REBAR SET, SAID POINT BEING THE POINT OF BEGINNING:

THENCE FROM SAID POINT OF BEGINNING AND ALONG THE COMMON LAND LOT LINE OF LAND LOTS 68 AND 95 NORTH 85 DEGREES 55 MINUTES 28 SECONDS WEST A DISTANCE OF 1,466.62 FEET TO A 1/2" REBAR SET, THENCE LEAVING SAID COMMON LAND LOT LINE NORTH 43 DEGREES 23 MINUTES 22 SECONDS EAST A DISTANCE OF 199.93 FEET TO A 1/2" REBAR SET, THENCE NORTH 09 DEGREES 24 MINUTES 48 SECONDS WEST A DISTANCE OF 59.00 FEET TO A 1/2" REBAR SET, THENCE NORTH 44 DEGREES 53 MINUTES 10 SECONDS EAST A DISTANCE OF 55.00 FEET TO A 1/2" REBAR FOUND, THENCE NORTH 50 DEGREES 32 MINUTES 16 SECONDS EAST A DISTANCE OF 142.98 FEET TO A 1/2" REBAR SET, NORTH 50 DEGREES 31 MINUTES 01 SECONDS EAST A DISTANCE OF 45.64 FEET TO A 1/2" REBAR SET, NORTH 42 DEGREES 50 MINUTES 31 SECONDS EAST A DISTANCE OF 176.34 FEET TO A 1/2" REBAR SET, THENCE NORTH 29 DEGREES 37 MINUTES 44 SECONDS EAST A DISTANCE OF 159.77 TO A 1/2" REBAR SET, THENCE NORTH 17 DEGREES 56 MINUTES 54 SECONDS EAST A DISTANCE OF 111.06 FEET TO A 1/2" REBAR SET, THENCE NORTH 79 DEGREES 35 MINUTES 56 SECONDS WEST A DISTANCE OF 84.90 FEET TO A 1/2" REBAR SET, THENCE NORTH 21 DEGREES 07 MINUTES 56 SECONDS EAST A DISTANCE OF 126.17 FEET TO A 1/2" REBAR SET, THENCE NORTH 80 DEGREES 21 MINUTES 24 SECONDS WEST A DISTANCE OF 180.00 FEET TO A 1/2" REBAR SET, THENCE SOUTH 15 DEGREES 42 MINUTES 16 SECONDS WEST A DISTANCE OF 122.00 FEET TO A 1/2" REBAR SET, THENCE NORTH 79 DEGREES 35 MINUTES 56 SECONDS WEST A DISTANCE OF 20.09 FEET TO A 1/2" REBAR SET, THENCE NORTH 15 DEGREES 42 MINUTES 16 SECONDS EAST A DISTANCE OF 178.59 FEET TO A 1/2" REBAR FOUND, THENCE NORTH 39 DEGREES 02 MINUTES 10 SECONDS WEST A DISTANCE OF 172.41 FEET TO A 1/2" REBAR SET, THENCE NORTH 05 DEGREES 33 MINUTES 10 SECONDS WEST A DISTANCE OF 40.00 FEET TO A 1/2" REBAR SET, THENCE NORTH 80 DEGREES 29 MINUTES 48 SECONDS WEST A DISTANCE OF 108.48 FEET TO A 1/2" REBAR SET, THENCE NORTH 00 DEGREES 11 MINUTES 14 SECONDS WEST A DISTANCE OF 43.60 FEET TO A 1/2" REBAR SET, THENCE SOUTH 87 DEGREES 40 MINUTES 47 SECONDS EAST A DISTANCE OF 199.27 FEET TO A 1/2" REBAR FOUND, THENCE NORTH 04 DEGREES 32 MINUTES 50 SECONDS EAST A DISTANCE OF 150.25 FEET TO A 1/2" REBAR FOUND ON THE SOUTHERN RIGHT OF WAY OF NORMAN ROAD (R/W VARIES), THENCE ALONG SAID R/W SOUTH 87 DEGREES 20 MINUTES 41 SECONDS EAST A DISTANCE 140.95 FEET TO A 1/2" REBAR FOUND, THENCE LEAVING SAID R/W SOUTH 02 DEGREES 39 MINUTES 19 SECONDS WEST A DISTANCE OF 250.00 FEET TO A 1/2" REBAR SET, THENCE SOUTH 87 DEGREES 20 MINUTES 41 SECONDS EAST A DISTANCE OF 140.00 FEET TO A 1/2" REBAR SET, THENCE NORTH 02 DEGREES 39 MINUTES 19 SECONDS EAST A DISTANCE OF 14.71 FEET TO A 1/2" REBAR SET, THENCE SOUTH 86 DEGREES 09 MINUTES 08 SECONDS EAST A DISTANCE OF 114.18 FEET TO A 1/2" REBAR SET, THENCE NORTH 02 DEGREES 30 MINUTES 19 SECONDS EAST A DISTANCE OF 240.00 FEET TO A 1/2" REBAR FOUND ON SAID SOUTHERN R/W, THENCE

ALONG SAID R/W SOUTH 88 DEGREES 22 MINUTES 59 SECONDS EAST A DISTANCE OF 626.34 FEET TO A 1/2" REBAR SET, THENCE LEAVING SAID R/W SOUTH 00 DEGREES 45 MINUTES 17 SECONDS WEST TO A 1/2" REBAR SET, THENCE SOUTH 88 DEGREES 22 MINUTES 59 SECONDS EAST A DISTANCE OF 140.02 FEET TO A 1/2" REBAR FOUND ON THE COMMON LAND LOT LINE OF LAND LOTS 94 AND 95, THENCE ALONG SAID COMMON LAND LOT LINE SOUTH 00 DEGREES 17 MINUTES 18 SECONDS A DISTANCE OF 1,256.11 FEET TO 1/2" REBAR SET ON THE COMMON LAND LOT CORNER OF LAND LOTS 68, 69, 94 AND 95, SAID POINT BEING THE POINT OF BEGINNING.

SAID TRACT OR PARCEL CONTAINS 34.93 AC/1,521,387 SQ.FT.

THIS BLOCK RESERVED FOR THE CLERK OF SUPERIOR COURT

LEGEND	
	UTILITY POLE
	SANITARY SEWER MANHOLE
	STORM DRAIN PIPE
	DOUBLE-WING CATCH BASIN
	SINGLE-WING CATCH BASIN
	JUNCTION BOX
	GRATE INLET
	SANITARY SEWER LINE
	WATER LINE
	GAS LINE
	ELECTRIC LINE
	FORCE MAIN
	FIBER OPTIC
	TELEPHONE LINE
	FENCE
	TOP OF BANK
	CENTERLINE
	TRAFFIC SIGNAL POLE
	TRAFFIC SIGNAL BOX
	POWER POLE
	LIGHT POLE
	TELEPHONE/CABLE BOX
	ELECTRICAL TRANSFORMER BOX
	SIGN
	FIRE HYDRANT
	WATER VALVE
	WATER METER
	WELL
	MONITORING WELL
	GAS VALVE
	GAS METER
	LIQUEFIED PROPANE GAS
	REBAR FOUND
	REBAR PIN SET
	RIGHT-OF-WAY MONUMENT
	CONCRETE
	REBAR PIN FOUND
	IRON PIN FOUND
	OPEN TOP PIPE FOUND
	CRIMP TOP PIPE FOUND
	R/W MONUMENT FOUND
	CORRUGATED METAL PIPE
	REINFORCED CONCRETE PIPE
	SANITARY SEWER
	POLYVINYL CHLORIDE PIPE

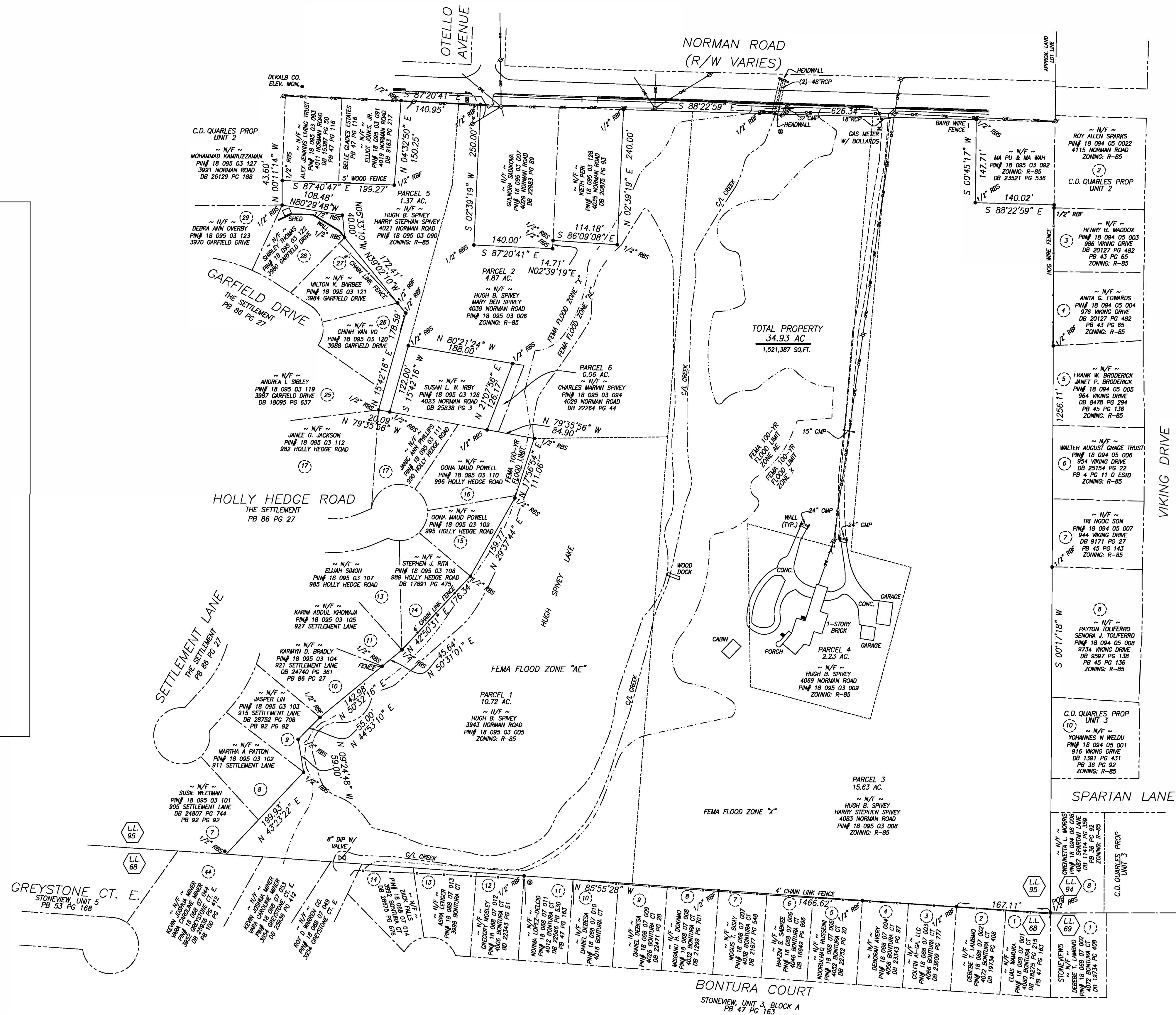
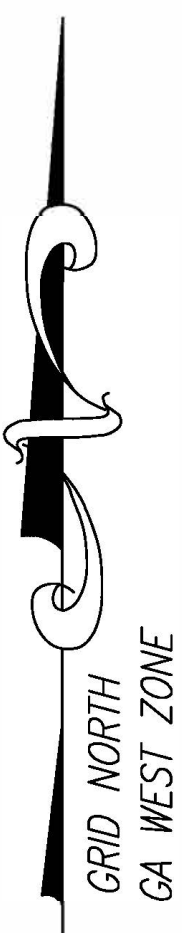

LEGAL DESCRIPTION

THAT CERTAIN TRACT OR PARCEL OF LAND LYING AND BEING IN LAND LOT 95 OF THE 18TH DISTRICT, 2ND SECTION, DEKALB COUNTY, GEORGIA AND MORE PARTICULARLY DESCRIBED AS FOLLOWS:

BEGINNING AT THE POINT OF INTERSECTION OF LAND LOTS 68, 69, 94 AND 95 AT A 1/2" REBAR SET, SAID POINT BEING THE POINT OF BEGINNING:

THENCE FROM SAID POINT OF BEGINNING AND ALONG THE COMMON LAND LOT LINE OF LAND LOTS 68 AND 95 NORTH 85 DEGREES 55 MINUTES 28 SECONDS WEST A DISTANCE OF 1,466.62 FEET TO A 1/2" REBAR SET, THENCE LEAVING SAID COMMON LAND LOT LINE NORTH 43 DEGREES 23 MINUTES 22 SECONDS EAST A DISTANCE OF 199.93 FEET TO A 1/2" REBAR SET, THENCE NORTH 09 DEGREES 24 MINUTES 48 SECONDS WEST A DISTANCE OF 59.00 FEET TO A 1/2" REBAR SET, THENCE NORTH 44 DEGREES 53 MINUTES 10 SECONDS EAST A DISTANCE OF 55.00 FEET TO A 1/2" REBAR FOUND, THENCE NORTH 50 DEGREES 32 MINUTES 16 SECONDS EAST A DISTANCE OF 142.98 FEET TO A 1/2" REBAR SET, NORTH 50 DEGREES 31 MINUTES 01 SECONDS EAST A DISTANCE OF 45.64 FEET TO A 1/2" REBAR SET, NORTH 42 DEGREES 50 MINUTES 31 SECONDS EAST A DISTANCE OF 176.34 FEET TO A 1/2" REBAR SET, THENCE NORTH 29 DEGREES 37 MINUTES 44 SECONDS EAST A DISTANCE OF 159.77 TO A 1/2" REBAR SET, THENCE NORTH 17 DEGREES 56 MINUTES 54 SECONDS EAST A DISTANCE OF 111.06 FEET TO A 1/2" REBAR SET, THENCE NORTH 79 DEGREES 35 MINUTES 56 SECONDS WEST A DISTANCE OF 84.90 FEET TO A 1/2" REBAR SET, THENCE NORTH 21 DEGREES 07 MINUTES 56 SECONDS EAST A DISTANCE OF 126.17 FEET TO A 1/2" REBAR SET, THENCE NORTH 80 DEGREES 21 MINUTES 24 SECONDS WEST A DISTANCE OF 180.00 FEET TO A 1/2" REBAR SET, THENCE SOUTH 15 DEGREES 42 MINUTES 16 SECONDS WEST A DISTANCE OF 122.00 FEET TO A 1/2" REBAR SET, THENCE NORTH 79 DEGREES 35 MINUTES 56 SECONDS WEST A DISTANCE OF 20.09 FEET TO A 1/2" REBAR SET, THENCE NORTH 15 DEGREES 42 MINUTES 16 SECONDS EAST A DISTANCE OF 178.59 FEET TO A 1/2" REBAR FOUND, THENCE NORTH 39 DEGREES 02 MINUTES 10 SECONDS WEST A DISTANCE OF 172.41 FEET TO A 1/2" REBAR SET, THENCE NORTH 05 DEGREES 33 MINUTES 10 SECONDS WEST A DISTANCE OF 40.00 FEET TO A 1/2" REBAR SET, THENCE NORTH 80 DEGREES 29 MINUTES 48 SECONDS WEST A DISTANCE OF 108.48 FEET TO A 1/2" REBAR SET, THENCE NORTH 00 DEGREES 11 MINUTES 14 SECONDS WEST A DISTANCE OF 43.60 FEET TO A 1/2" REBAR SET, THENCE SOUTH 87 DEGREES 40 MINUTES 47 SECONDS EAST A DISTANCE OF 199.27 FEET TO A 1/2" REBAR FOUND, THENCE NORTH 04 DEGREES 32 MINUTES 50 SECONDS EAST A DISTANCE OF 150.25 FEET TO A 1/2" REBAR FOUND ON THE SOUTHERN RIGHT OF WAY OF NORMAN ROAD (R/W VARIES), THENCE ALONG SAID R/W SOUTH 87 DEGREES 20 MINUTES 41 SECONDS EAST A DISTANCE 140.95 FEET TO A 1/2" REBAR FOUND, THENCE LEAVING SAID R/W SOUTH 02 DEGREES 39 MINUTES 19 SECONDS WEST A DISTANCE OF 250.00 FEET TO A 1/2" REBAR SET, THENCE SOUTH 87 DEGREES 20 MINUTES 41 SECONDS EAST A DISTANCE OF 140.00 FEET TO A 1/2" REBAR SET, THENCE NORTH 02 DEGREES 39 MINUTES 19 SECONDS EAST A DISTANCE OF 14.71 FEET TO A 1/2" REBAR SET, THENCE SOUTH 86 DEGREES 09 MINUTES 08 SECONDS EAST A DISTANCE OF 114.18 FEET TO A 1/2" REBAR SET, THENCE NORTH 02 DEGREES 30 MINUTES 19 SECONDS EAST A DISTANCE OF 240.00 FEET TO A 1/2" REBAR FOUND ON SAID SOUTHERN R/W, THENCE ALONG SAID R/W SOUTH 88 DEGREES 22 MINUTES 59 SECONDS EAST A DISTANCE OF 626.34 FEET TO A 1/2" REBAR SET, THENCE LEAVING SAID R/W SOUTH 00 DEGREES 45 MINUTES 17 SECONDS WEST TO A 1/2" REBAR SET, THENCE SOUTH 88 DEGREES 22 MINUTES 59 SECONDS EAST A DISTANCE OF 140.02 FEET TO A 1/2" REBAR FOUND ON THE COMMON LAND LOT LINE OF LAND LOTS 94 AND 95, THENCE ALONG SAID COMMON LAND LOT LINE SOUTH 00 DEGREES 17 MINUTES 18 SECONDS A DISTANCE OF 1,256.11 FEET TO 1/2" REBAR SET ON THE COMMON LAND LOT CORNER OF LAND LOTS 68, 69, 94 AND 95, SAID POINT BEING THE POINT OF BEGINNING.

SAID TRACT OR PARCEL CONTAINS 34.93 AC/1,521,387 SQ.FT.

SURVEYOR'S NOTES

1. THE FIELD DATA ON WHICH THIS PLAT IS BASED WAS COMPLETED ON FEBRUARY 18, 2021.
2. THE FIELD DATA ON WHICH THIS PLAT IS BASED HAS A CLOSURE OF ONE FOOT IN 82,235 FEET AND AN ANGULAR ERROR OF 1" PER ANGLE, AND WAS ADJUSTED USING LEAST SQUARES.
3. THE LINEAR AND ANGULAR MEASUREMENTS SHOWN ON THIS PLAT WERE OBTAINED BY FIELD SURVEY USING A GEOMAX 90 ELECTRONIC TOTAL STATION.
4. THIS PLAT HAS BEEN CALCULATED FOR CLOSURE AND IS FOUND TO BE ACCURATE WITHIN ONE FOOT IN 480,750 FEET.
5. LOCATION AND ARRANGEMENT OF UNDERGROUND UTILITIES ARE PROVIDED BY VISIBLE ACCESSIBLE FIELD EVIDENCE. THERE IS NO CERTAINTY OF THE ACCURACY OF THIS INFORMATION AND IT SHALL BE CONSIDERED IN THAT LIGHT BY THOSE USING THIS SURVEY. UTILITIES AND STRUCTURES NOT SHOWN MAY BE ENCOUNTERED. THE OWNER, HIS CONSULTANTS, AND HIS CONTRACTORS SHALL HEREBY DISTINCTLY UNDERSTAND THAT THIS SURVEYOR IS NOT RESPONSIBLE FOR THE SUFFICIENCY OF THE UNDERGROUND UTILITY INFORMATION PROVIDED HEREON.
6. REFERENCES: THE SETTLEMENT PB 86 PG 27
STONEVIEW PB 47 PG 163
VIKING ESTATES PB 43 PG 136

JACOB & HEFNER ASSOCIATES
 3440 Blue Springs Road NW, Suite 101
 Kennesaw, GA 30144
 PHONE: (770) 672-2276
 www.jacobandhefner.com

BOUNDARY SURVEY FOR:
 ALDERWOOD CAPITAL, INC.
 LOCATED IN LAND LOT 95, 18TH DISTRICT ~ 2ND SECTION
 DEKALB COUNTY, GEORGIA



FLOOD NOTE
 THIS PROPERTY DOES LIE WITHIN AN AREA HAVING SPECIAL FLOOD HAZARDS AS PER FEMA FIRM MAP # 13089 C 0086 K DATED MARCH 4, 2019. PROPERTY LIES WITHIN A FLOOD HAZARD AREAS DESIGNATED ZONE X AND AE.

Survey No.:	G126
Ordered By.:	
Description:	SURVEY
Date Prepared:	3-8-2021
Scale:	1"=100'
	SHEET 1

NORMAN RO
(R/W VARIE)

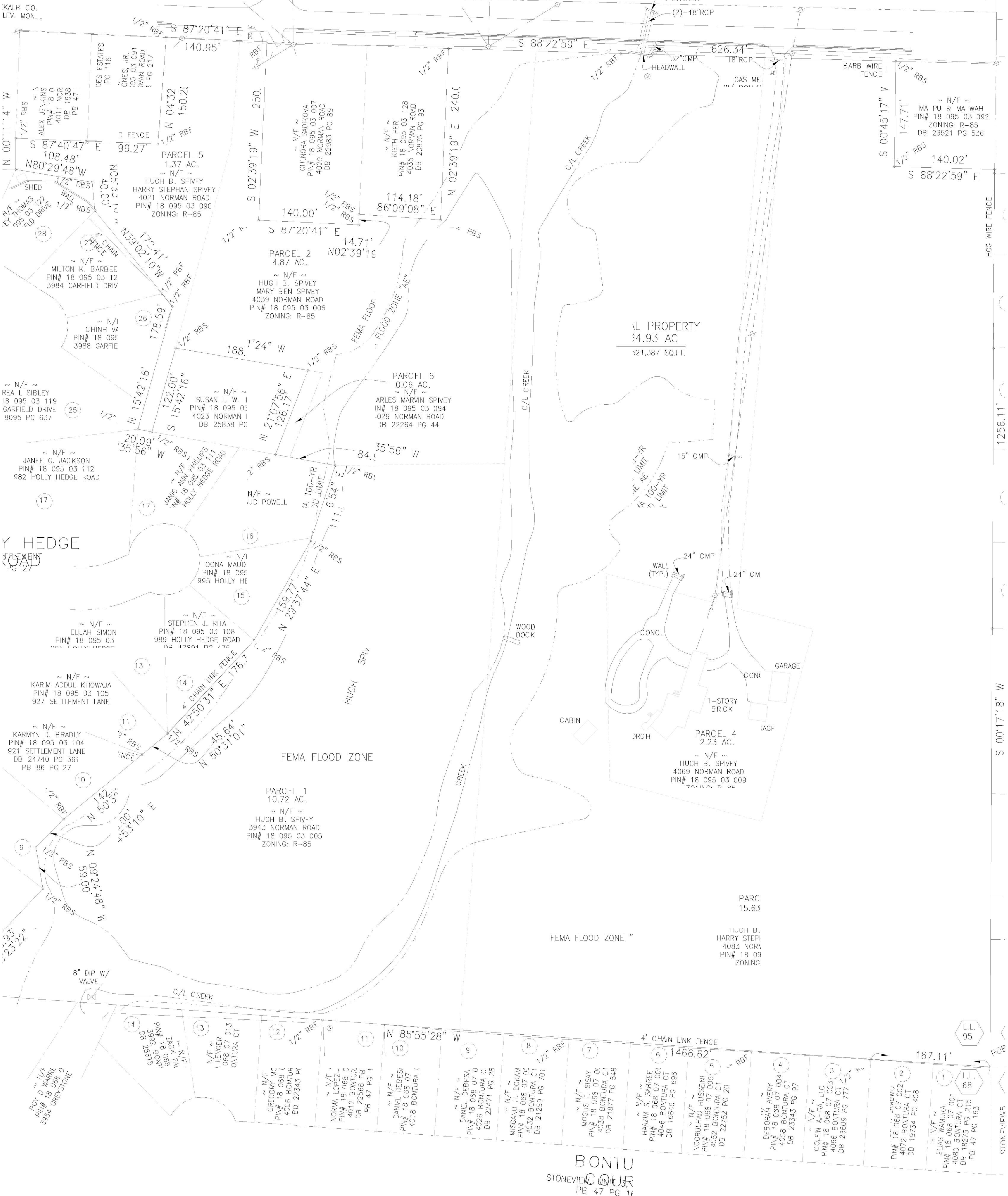

1 SURVEY
50-10 1" = 60'-0"



HIGH SPIVEY LAKE

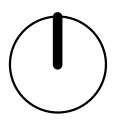
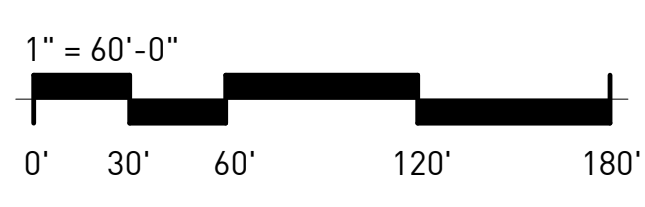

NORMAN RO
(R/W VARIE)

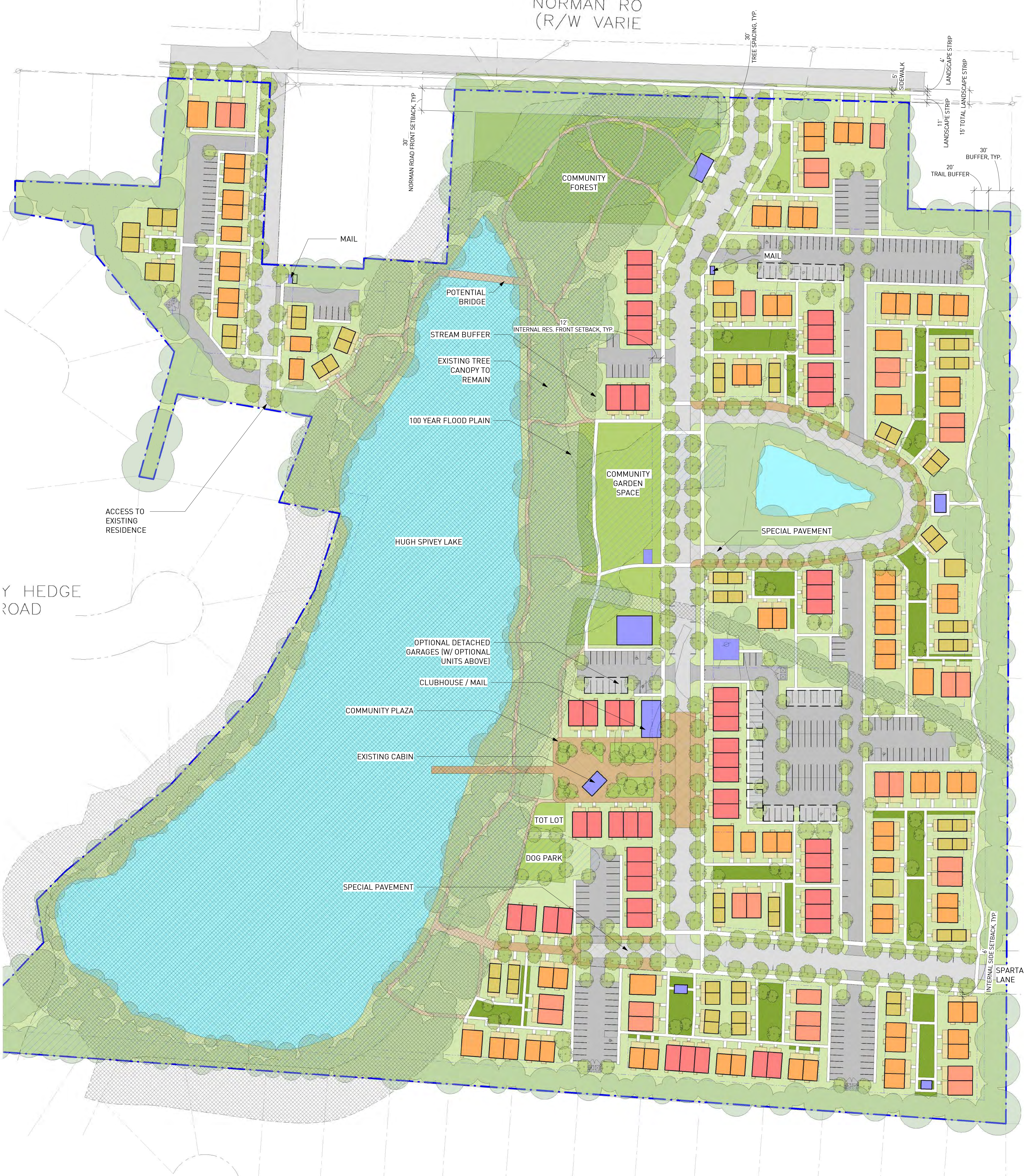

Y HEDGE ROAD

BONTU COUR

SITE PLAN LEGEND	
[Yellow Box]	BUILDING - 1 BEDROOM
[Orange Box]	BUILDING - 2 BEDROOM
[Red Box]	BUILDING - 3 BEDROOM
[Blue Box]	BUILDING - TOWNHOUSE
[Purple Box]	BUILDING - COMMUNITY USE
[Light Yellow Box]	PORCH
[Light Blue Box]	NEW SIDEWALK
[Light Green Box]	NATURAL WALKING PATH
[Light Brown Box]	PLAZA
[Light Green Box]	NEW LANDSCAPE
[Dark Green Box]	COTTAGE COURT
[Hatched Box]	100 YEAR FLOOD PLAIN
[Cross-hatched Box]	STREAM BUFFER

PROJECT INFO	
UNITS	
1 - BEDROOM ADU HOMES:	6
1 - BEDROOM HOMES:	58
2 - BEDROOM HOMES:	82
3 - BEDROOM HOMES:	27
TOWNHOUSE HOMES:	55
TOTAL HOMES:	228
PARKING	
OFF-STREET:	308 (APP. 285 W/ GARAGES)
ON-STREET:	80
TOTAL PARKING:	388 (APP. 365 W/ GARAGES)

1 SITE PLAN
50'-1" 1" = 60'-0"



HUGH SPIVEY LAKE

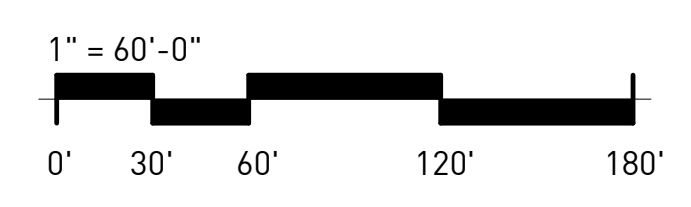

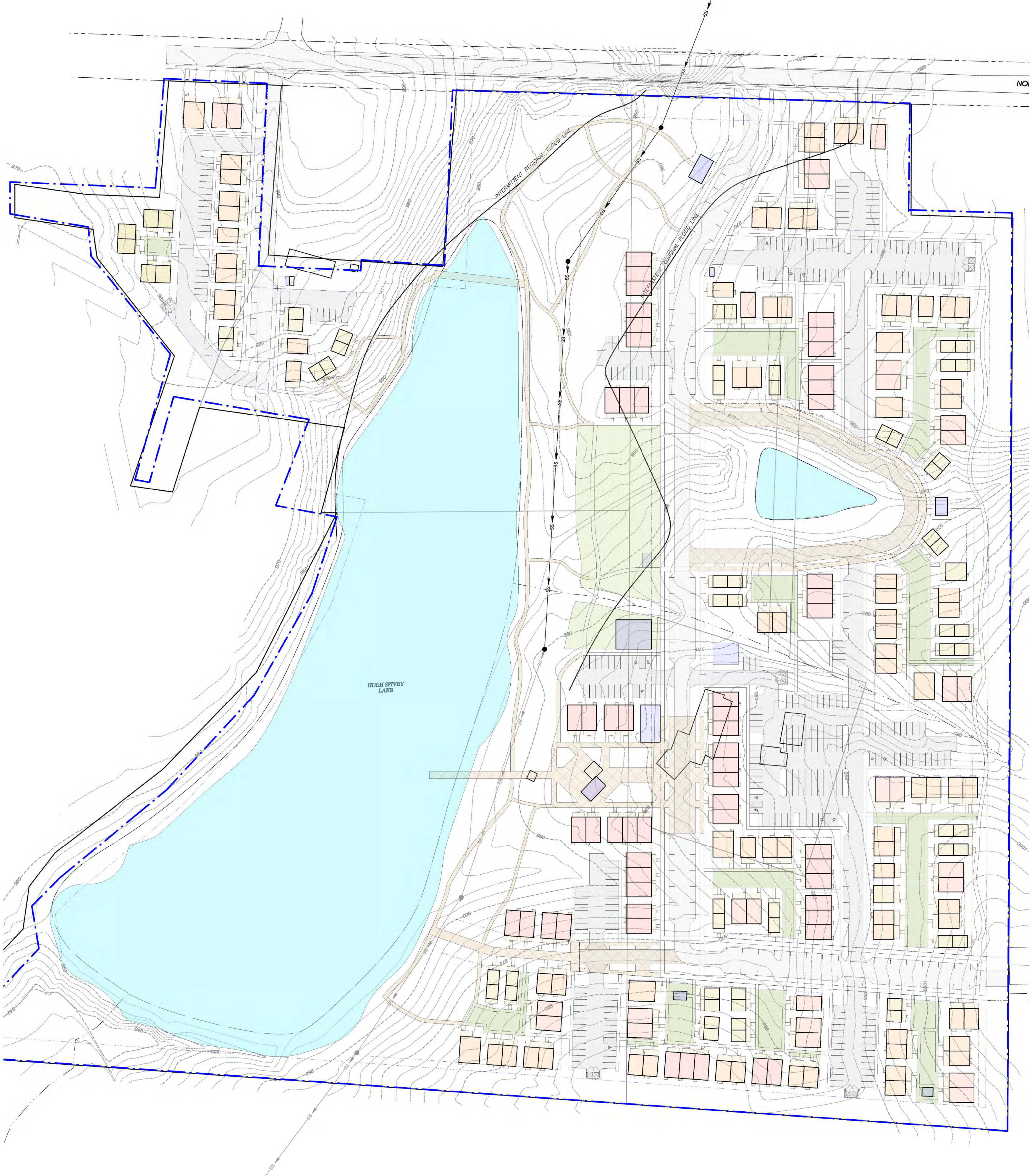

NORMAN RO
(R/W VARIE)

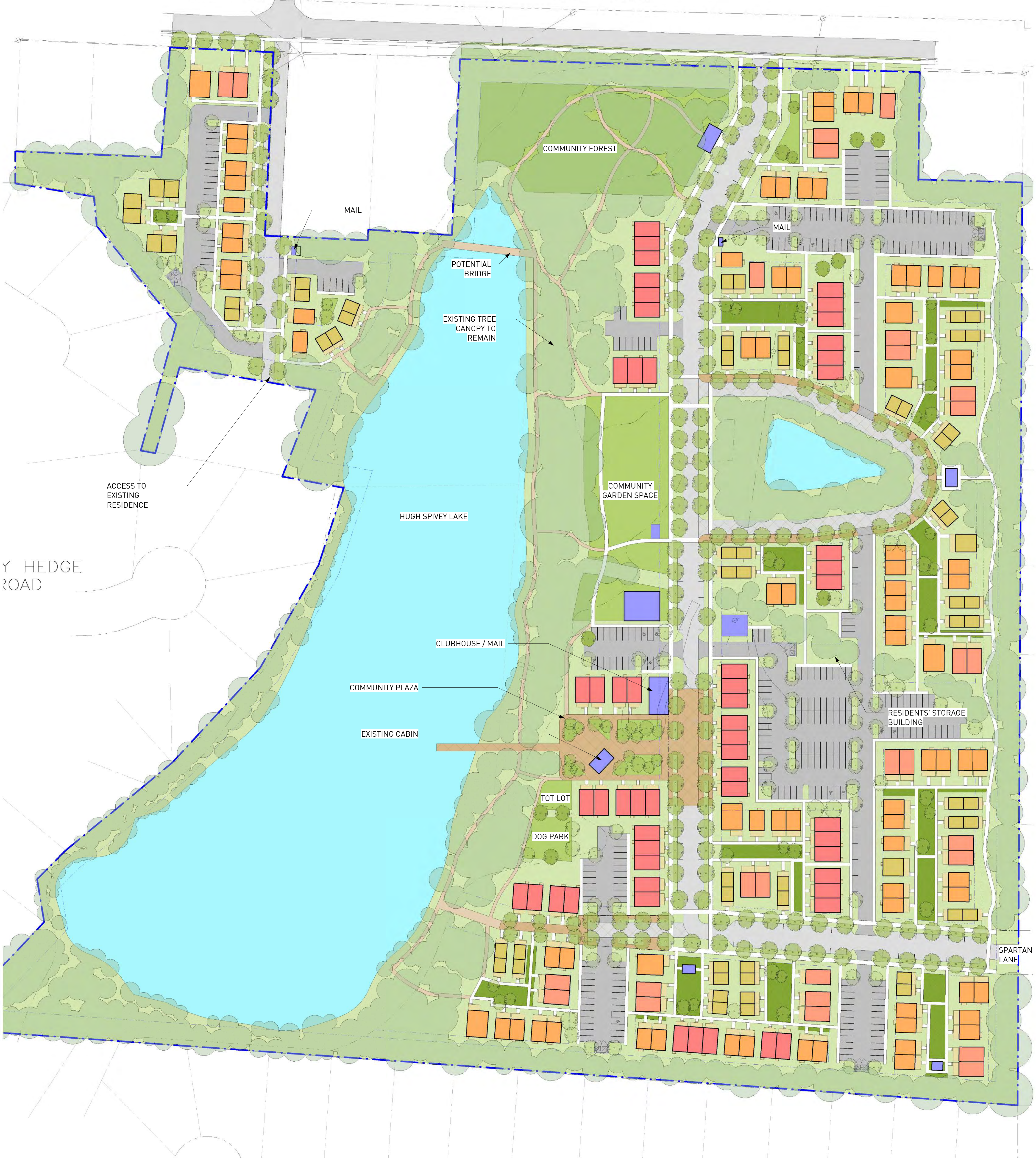

SITE PLAN LEGEND	
	BUILDING - 1 BEDROOM
	BUILDING - 2 BEDROOM
	BUILDING - 3 BEDROOM
	BUILDING - TOWNHOUSE
	BUILDING - COMMUNITY USE
	PORCH
	NEW SIDEWALK
	NATURAL WALKING PATH
	PLAZA
	NEW LANDSCAPE
	COTTAGE COURT

PROJECT INFO	
UNITS	
1 - BEDROOM ADU HOMES:	6
1 - BEDROOM HOMES:	58
2 - BEDROOM HOMES:	82
3 - BEDROOM HOMES:	27
TOWNHOUSE HOMES:	55
TOTAL HOMES:	228
PARKING	
OFF-STREET:	308 (APP. 285 W/ GARAGES)
ON-STREET:	80
TOTAL PARKING:	388 (APP. 365 W/ GARAGES)

1 SITE PLAN - COMMUNITY
50-13 1" = 60'-0"



HUGH SPIVEY LAKE

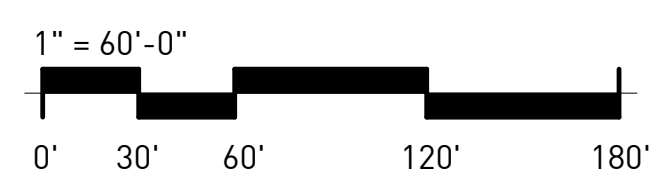

Home Type	# Bed	# Bath	Height (# of Stories)	Square Footage	Count in Plan
1-A	1	1	1	800	8
1-B	1	1	2	800	56
2-A	2	2	2	1,020	75
2-B	2	2	1	1,010	7
3-B	3	3	2	1,270	27
Townhouse	2-3	2.5	2	1,320	55
Total	-	-	-	-	228

Density	
Total Acreage of Site	34.93
Total # of Homes	228
Homes/AC	6.53

Density Bonus Calcs	
Base Density (Home/AC)	4
Public Improvement Bonus	20%
Amenity Proximity Bonus	20%
Additional Enhanced Open Space Bonus	50%
Total Allowed Density (Home/AC)	7.60

Public Improvement Bonus: Applicant provides public trail access

Amenity Proximity Bonus: Site is within 1/4 mile of Jolly Elementary School

Additional Enhanced Open Space Bonus: Enhanced open space comprises 20% of overall site

Parking	
Total # of Homes	228
# of Off-Street Parking Spaces	308
# of On-Street Parking Spaces	80
Total # of Parking Spaces	388
Parking Ratio (Spaces/Home)	1.70

Impervious Surface Calculations			
Impervious Surface Type	SF	Ac	% of Total Land
Street	99,516	2.28	6.54%
Sidewalks	74,984	1.72	4.93%
Parking	120,288	2.76	7.91%
Plaza	24,460	0.56	1.61%
Buildings/Porches	165,071	3.79	10.85%
Total Impervious Surface	484,319	11.12	31.83%
Total Pervious Surface	1,037,232	23.81	68.17%

Open Space Amenity Calcs			
Open Space Type	SF	AC	% of Total Land
Area of Lake/Pond	328,793	7.55	21.61%
Area of Cottage Courts	46,819	1.07	3.08%
Area of Community Plaza	16,641	0.38	1.09%
Community Garden	33,100	0.76	2.18%
Community Forest	44,335	1.02	2.91%
Natural Walking Trails	18,247	0.42	1.20%
Untouched Tree Land	379,391	8.71	24.93%
Total Area of Amenitized Open Space	487,935	11.20	32.07%
Total Area of Untouched / Amenitized land	894,713	20.54	58.80%

Trail Network		
	Feet	Miles
Linear Distance of Trails / Sidewalks	17,093	3.24

Materials Used
Fiber cement (Hardi-Plank) for exterior siding and asphalt shingles for roofing.

HOME TYPES

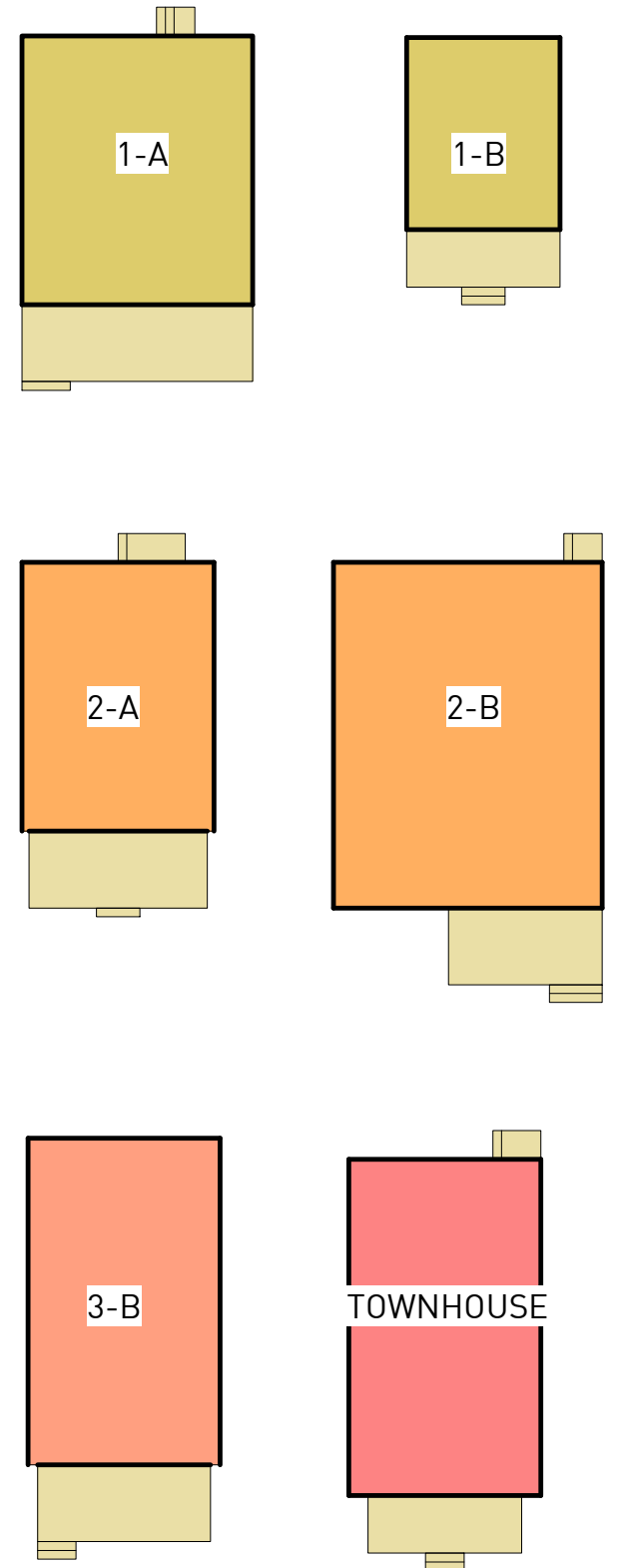

PROGRAM CALCS

HUGH SPIVEY LAKE

SD - 1.5

04/26/21



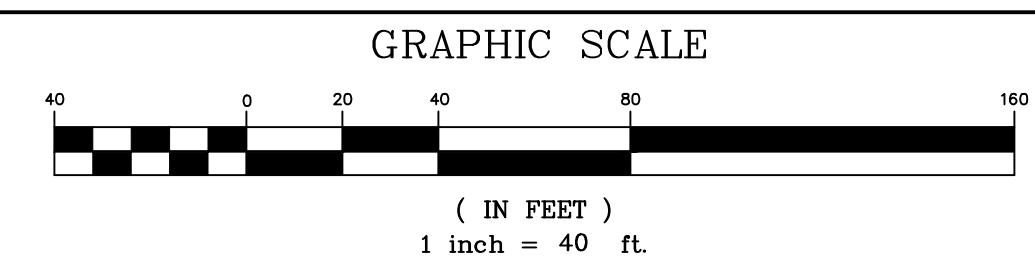

MATERIALS HATCH LEGEND:

- ASPHALT AND CONCRETE PAVING
- SPECIALTY PAVING
- LIMITS OF 100-YR FLOOD ZONE
- BUILDINGS
- SIDEWALKS AND PATHS
- LIMIT OF FLOOD ZONE
- WATER FEATURE BUFFERS
- WATER FEATURE EDGE/CENTER LINES
- SITE WALL

NORMAN ROAD
 (R/W VARIES)

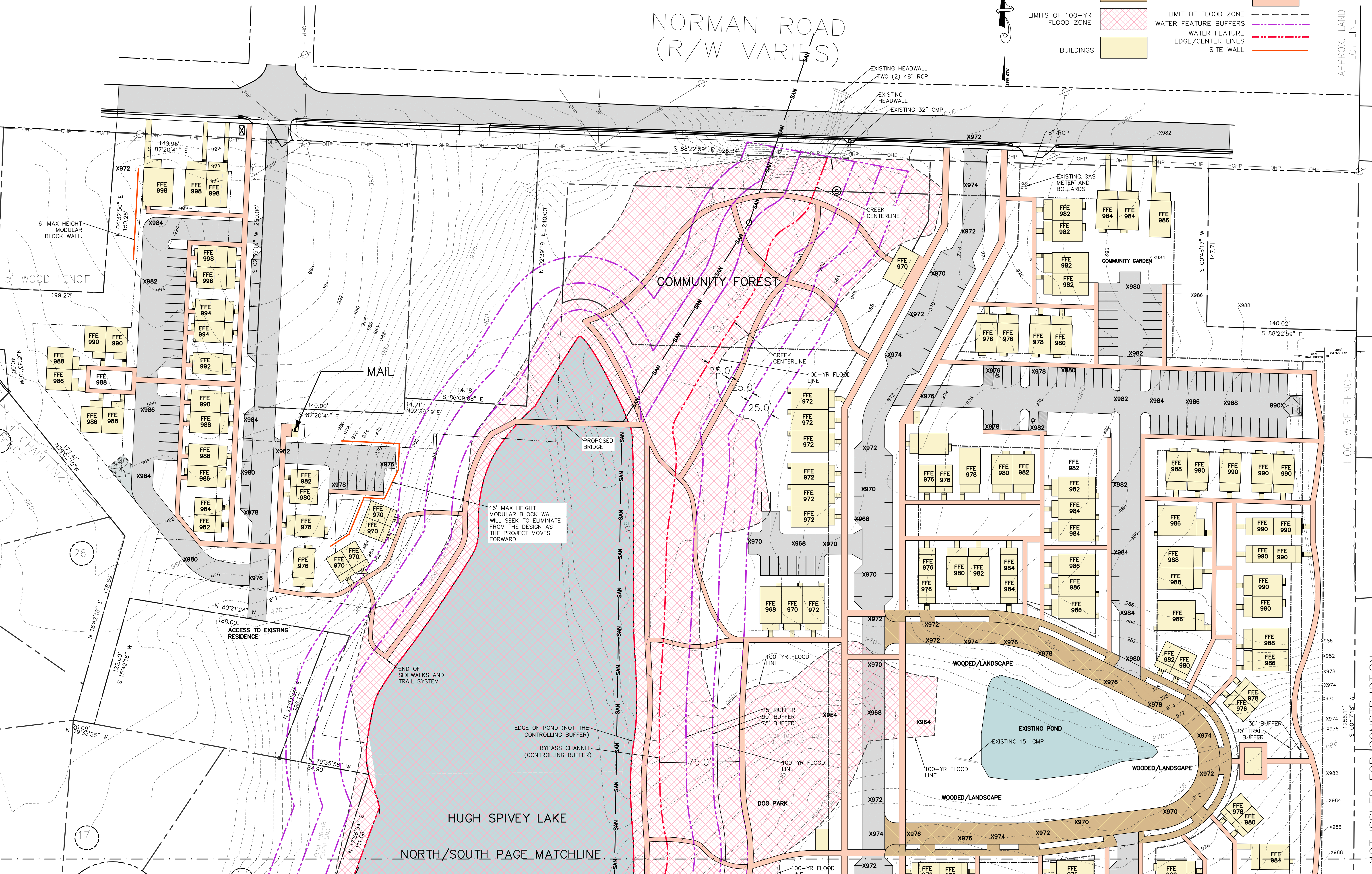

KRONBERG
URBANISTS
ARCHITECTS



HUGH SPIVEY LAKE
 UNINCORPORATED DEKALB COUNTY, GA

MARK	DATE	DESCRIPTION
	04.26.21	CONCEPT DESIGN/ZONING PLAN

PROJECT ID	HSL
DRAWN BY	PF
CHECKED BY	PF
SHEET TITLE	

DRAWING NO.	C1.0
-------------	------

NOT ISSUED FOR CONSTRUCTION

MATERIALS HATCH LEGEND:

	ASPHALT AND CONCRETE PAVING		SIDEWALKS AND PATHS
	SPECIALTY PAVING		LIMIT OF FLOOD ZONE
	BUILDINGS		WATER FEATURE BUFFERS
			EDGE/CENTER LINES
			SITE WALL

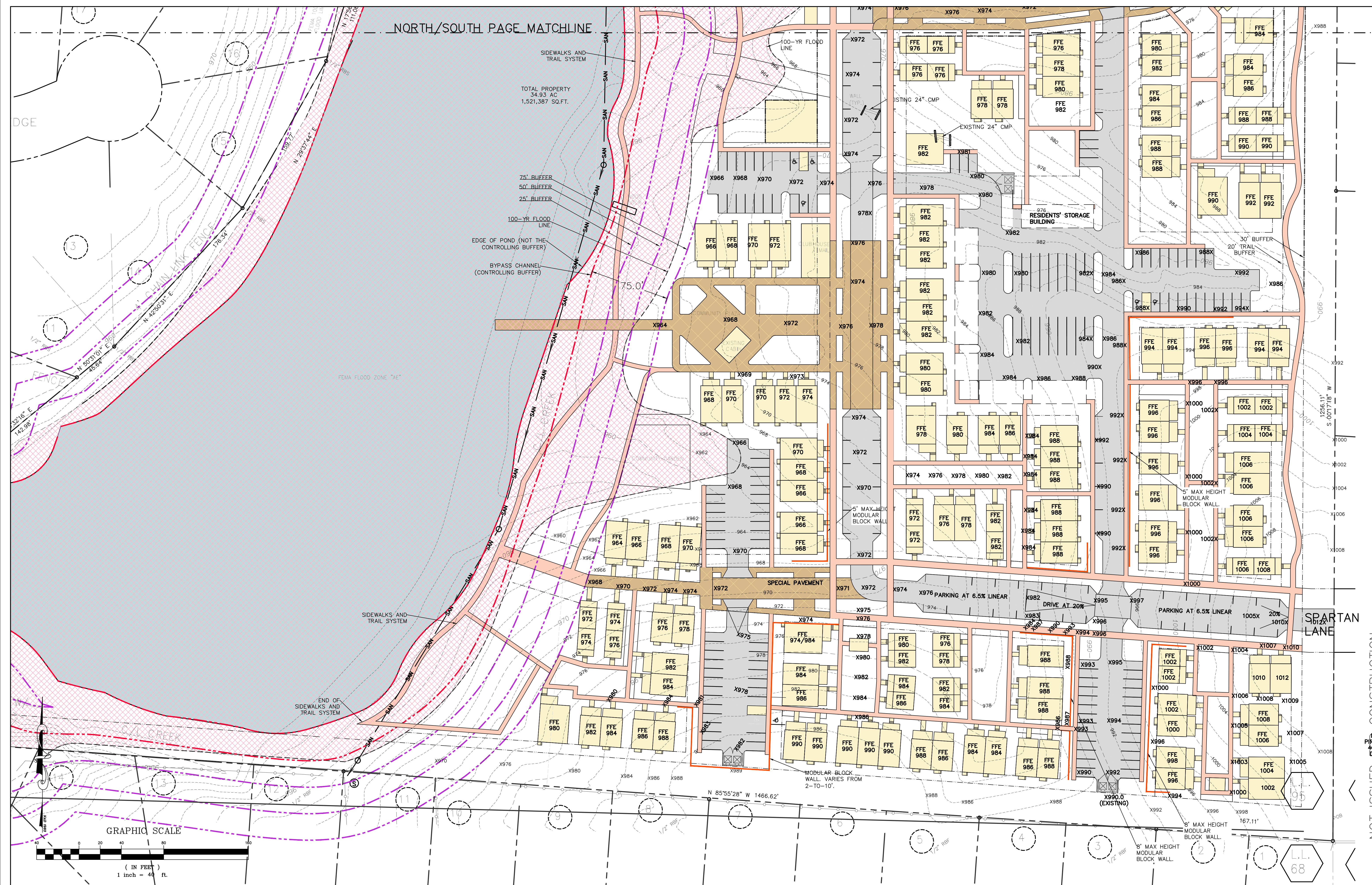

NORTH/SOUTH PAGE MATCHLINE

TOTAL PROPERTY
34.93 AC
1,521,387 SQ.FT.

75' BUFFER
50' BUFFER
25' BUFFER
100-YR FLOOD LINE
EDGE OF POND (NOT THE CONTROLLING BUFFER)
BYPASS CHANNEL (CONTROLLING BUFFER)

FEMA FLOOD ZONE "AE"

SIDEWALKS AND TRAIL SYSTEM
END OF SIDEWALKS AND TRAIL SYSTEM

MODULAR BLOCK WALL VARIES FROM 2'-10'-10'

SPARTAN LANE

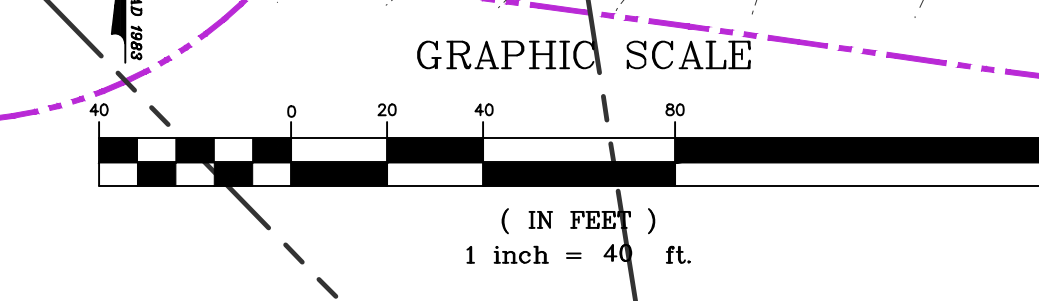

**KRONBERG
URBANISTS
ARCHITECTS**



HUGH SPIVEY LAKE
UNINCORPORATED DEKALB COUNTY, GA

MARK	DATE	DESCRIPTION
	04.26.21	CONCEPT DESIGN/ZONING PLAN

PROJECT ID	HSL
DRAWN BY	PF
CHECKED BY	PF
SHEET TITLE	

DRAWING NO.	C2.0
-------------	------

NOT ISSUED FOR CONSTRUCTION

NORMAN ROAD (R/W VARIES)

MATERIALS HATCH LEGEND:

ASPHALT AND CONCRETE PAVING	
SPECIALTY PAVING	
LIMITS OF 100-YR FLOOD ZONE	
BUILDINGS	
SIDEWALKS AND PATHS	
LIMIT OF FLOOD ZONE WATER FEATURE BUFFERS	
WATER FEATURE EDGE/CENTER LINES	
SITE WALL	

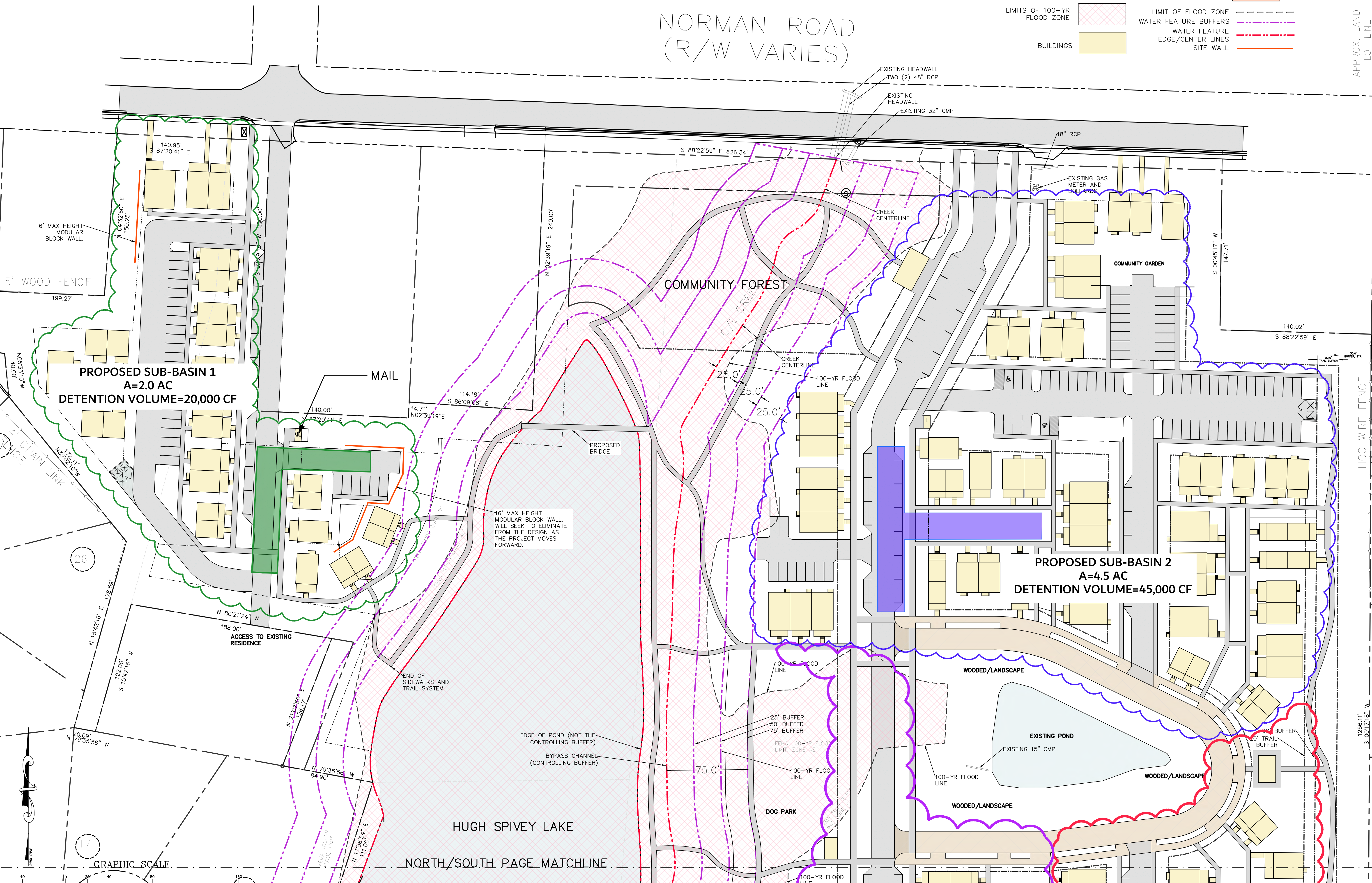

**KRONBERG
URBANISTS
ARCHITECTS**



HUGH SPIVEY LAKE
UNINCORPORATED DEKALB COUNTY, GA

MARK	DATE	DESCRIPTION
	04.26.21	CONCEPT DESIGN/ZONING PLAN

PROJECT ID	HSL
DRAWN BY	PF
CHECKED BY	PF
SHEET TITLE	

**DETENTION CONCEPT
PLAN NORTH**

DRAWING NO: **C2.1**

(IN FEET)
1 inch = 40 ft.

NOT ISSUED FOR CONSTRUCTION

MATERIALS HATCH LEGEND:

ASPHALT AND CONCRETE PAVING	
SPECIALTY PAVING	
LIMITS OF 100-YR FLOOD ZONE	
BUILDINGS	
SIDEWALKS AND PATHS	
LIMIT OF FLOOD ZONE	
WATER FEATURE BUFFERS	
WATER FEATURE EDGE/CENTER LINES	

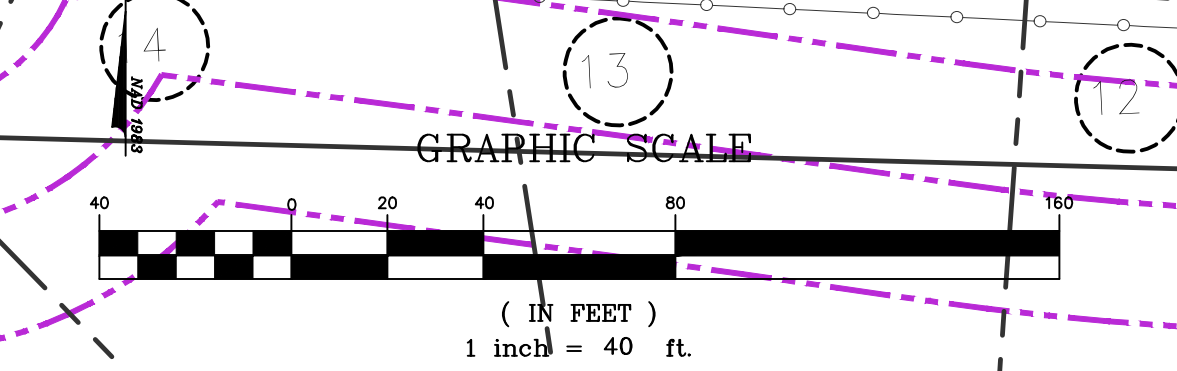
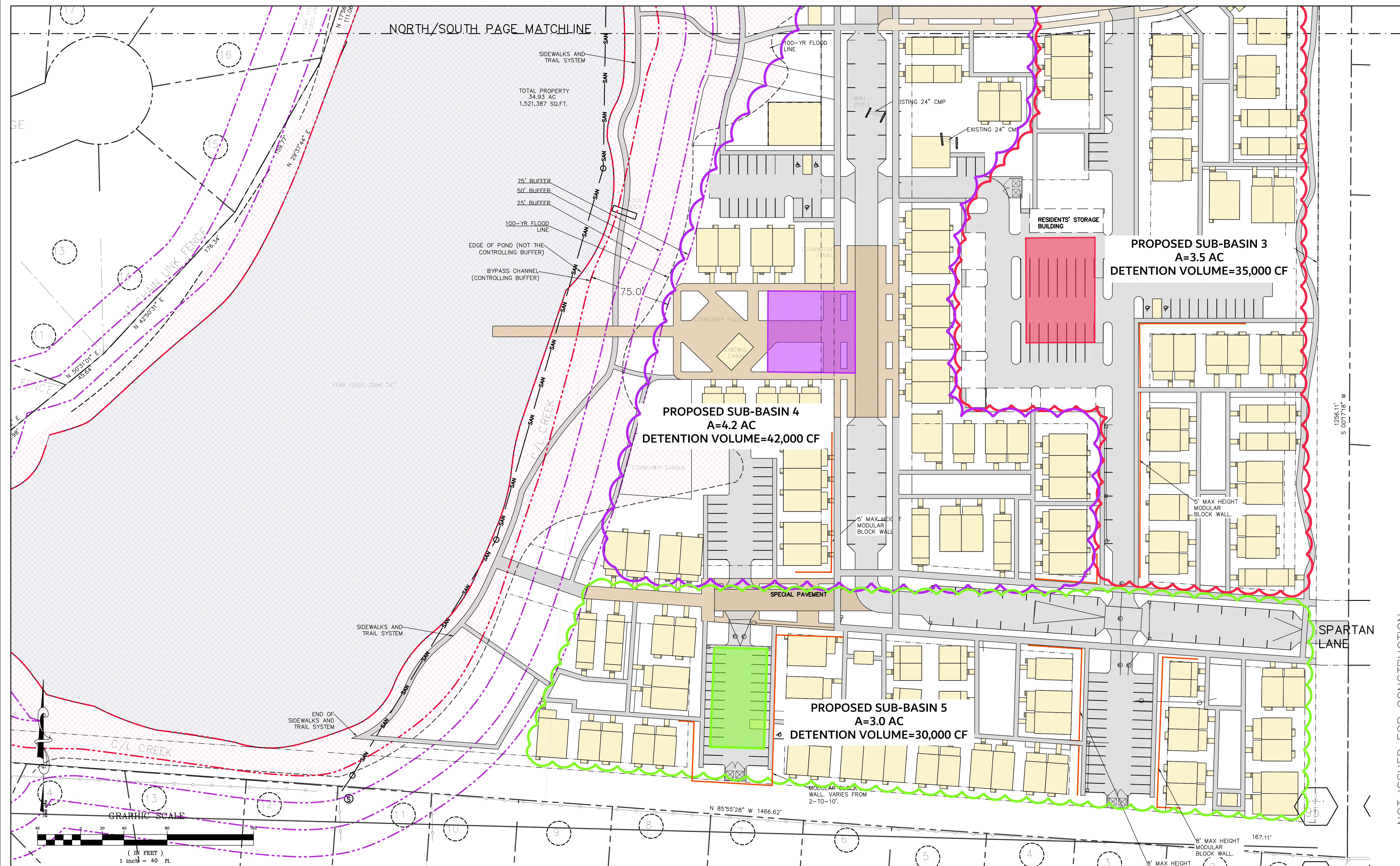

KRONBERG
URBANISTS
ARCHITECTS



HUGH SPIVEY LAKE
UNINCORPORATED DEKALB COUNTY, GA

NOT ISSUED FOR CONSTRUCTION

MARK	DATE	DESCRIPTION
	04.26.21	CONCEPT DESIGN/ZONING PLAN

PROJECT ID	HSL
DRAWN BY	PF
CHECKED BY	PF
SHEET TITLE	

DETENTION CONCEPT PLAN SOUTH

DRAWING NO.	C2.2
-------------	------

NORMAN ROAD (R/W VARIES)

APPROX. LAND
LOT LINE

**KRONBERG
URBANISTS
ARCHITECTS**



HUGH SPIVEY LAKE
UNINCORPORATED DEKALB COUNTY, GA

MARK	DATE	DESCRIPTION
	04.26.21	CONCEPT DESIGN/ZONING PLAN

PROJECT ID	HSL
DRAWN BY	PF
CHECKED BY	PF
SHEET TITLE	

**SEWER CONCEPT
NORTH**

DRAWING NO.	C3.1
-------------	------

NOT ISSUED FOR CONSTRUCTION

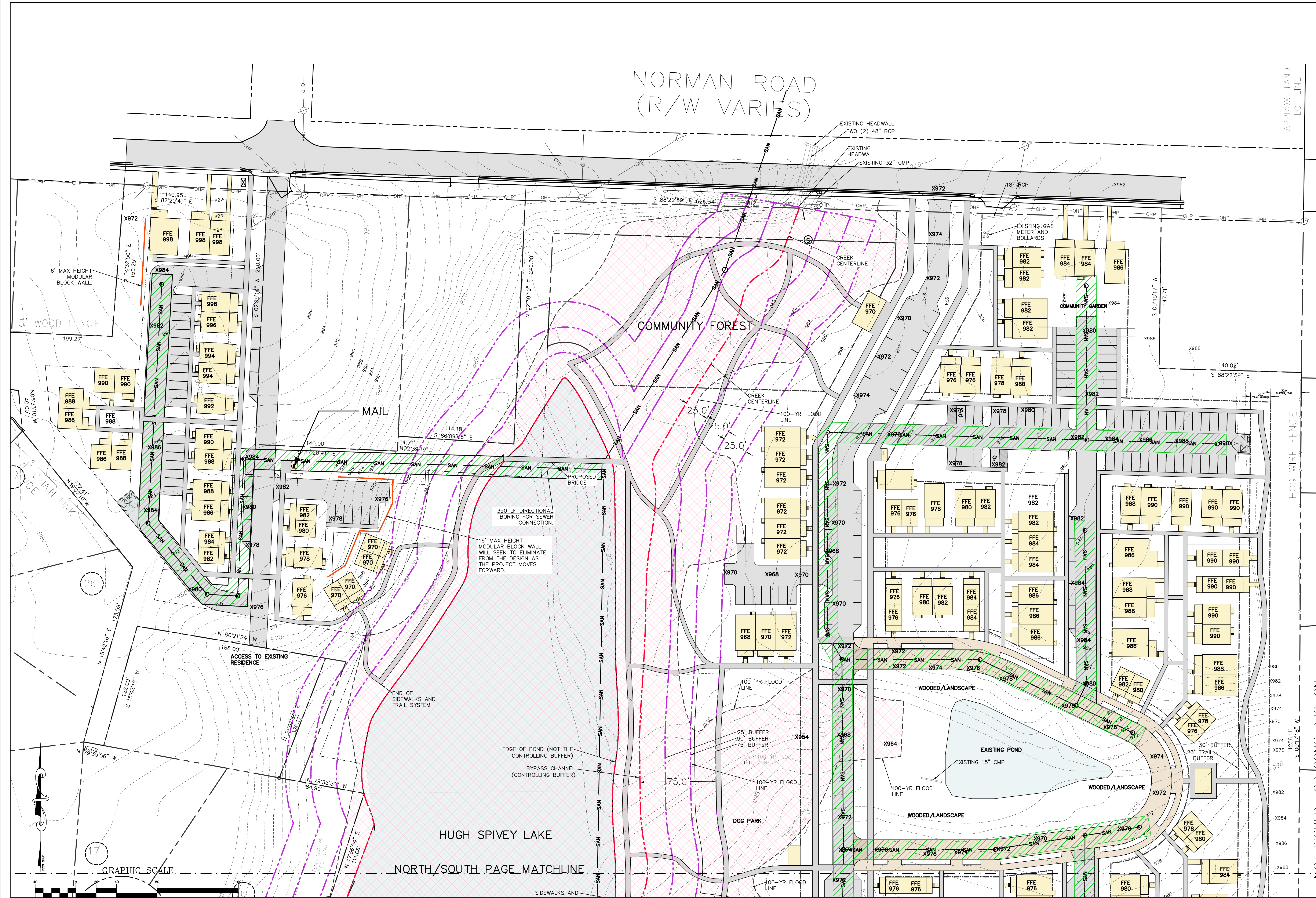

(IN FEET)
1 inch = 40 ft.

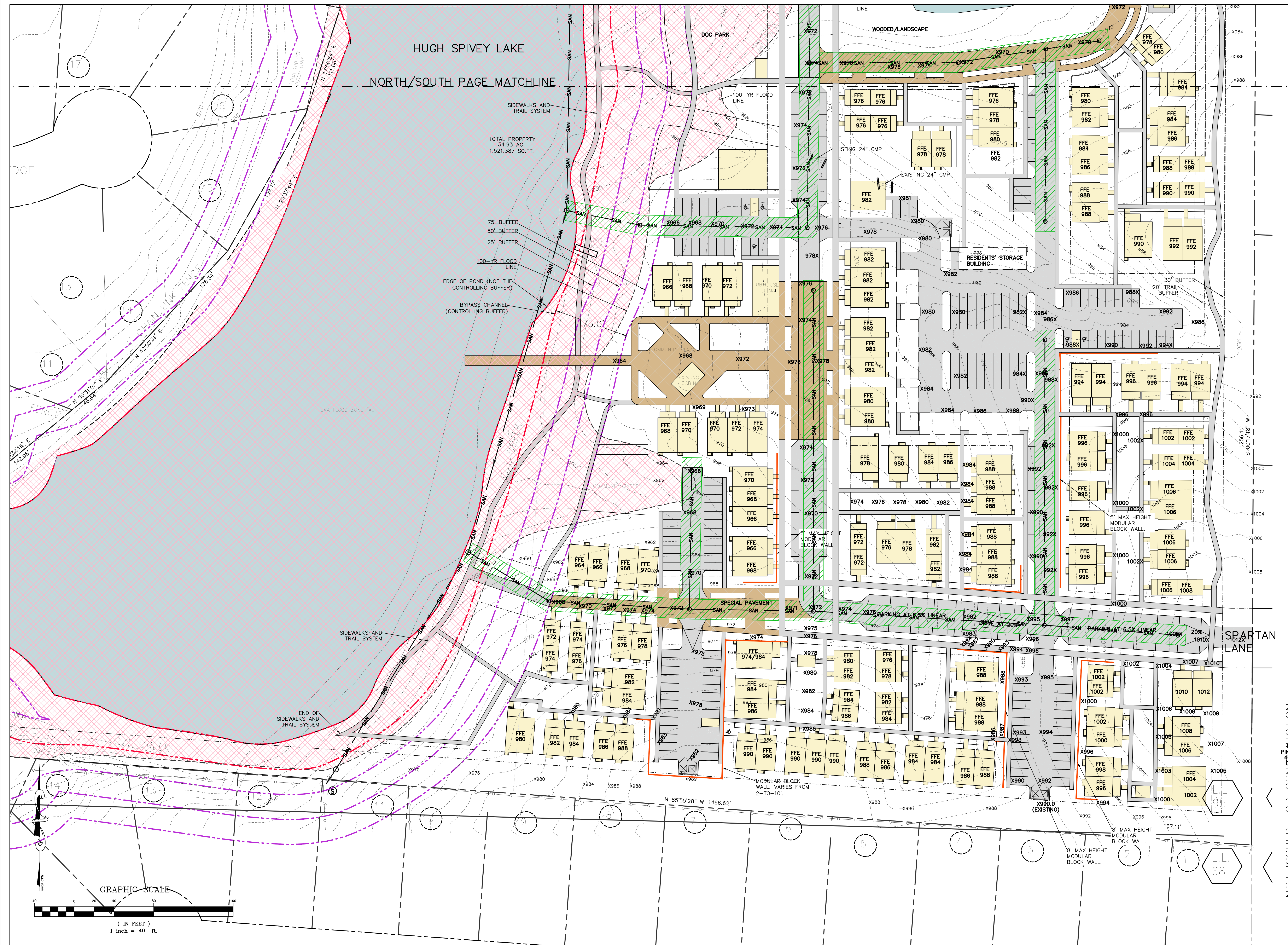

HUGH SPIVEY LAKE
NORTH/SOUTH PAGE MATCHLINE

TOTAL PROPERTY
34.93 AC
1,521,387 SQ.FT.

75' BUFFER
50' BUFFER
25' BUFFER
100-YR FLOOD LINE
EDGE OF POND (NOT THE CONTROLLING BUFFER)
BYPASS CHANNEL (CONTROLLING BUFFER)

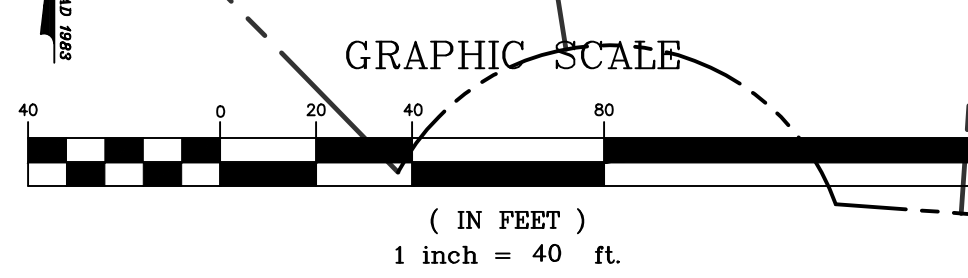

HUGH SPIVEY LAKE
UNINCORPORATED DEKALB COUNTY, GA

NOT ISSUED FOR CONSTRUCTION

MARK	DATE	DESCRIPTION
04.26.21		CONCEPT DESIGN/ZONING PLAN

PROJECT ID	HSL
DRAWN BY	PF
CHECKED BY	PF
SHEET TITLE	

SEWER CONCEPT SOUTH

DRAWING NO.	C3.2
-------------	------

ONE BEDROOM HOMES



1 BED COTTAGE



- 1 KITCHEN
- 2 LIVING
- 3 FRONT PORCH
- 4 BEDROOM
- 5 BATHROOM
- 6 MECH CLOSET

1 BED COTTAGE



- 1 KITCHEN
- 2 LIVING
- 3 FRONT PORCH
- 4 BEDROOM
- 5 BATHROOM
- 6 MECH CLOSET

1 BED COTTAGE



- 1 KITCHEN
- 2 LIVING
- 3 FRONT PORCH
- 4 BEDROOM
- 5 BATHROOM
- 6 MECH CLOSET
- 7 POWDER

TWO BEDROOM HOMES



2 BED COTTAGE



- 1 KITCHEN
- 2 LIVING
- 3 FRONT PORCH
- 4 BEDROOM
- 5 BATHROOM

2 BED COTTAGE



- 1 KITCHEN
- 2 LIVING
- 3 FRONT PORCH
- 4 BEDROOM
- 5 BATHROOM
- 6 MECH CLOSET
- 7 POWDER



THREE BEDROOM HOMES & TOWNHOUSES

3 BED COTTAGE



- 1 KITCHEN
- 2 LIVING
- 3 FRONT PORCH
- 4 BEDROOM
- 5 BATHROOM
- 6 MECH CLOSET

TOWNHOUSE



- 1 KITCHEN
- 2 LIVING
- 3 FRONT PORCH
- 4 BEDROOM
- 5 BATHROOM
- 6 MECH CLOSET

DUPLEXES



DUPLEX COTTAGE



- 1 KITCHEN
- 2 LIVING
- 3 FRONT PORCH
- 4 BEDROOM
- 5 BATHROOM

DUPLEX COTTAGE



- 1 KITCHEN
- 2 LIVING
- 3 FRONT PORCH
- 4 BEDROOM
- 5 BATHROOM

STATEMENT OF INTENT

and

Other Material Required by
DeKalb County Zoning Ordinance
For
A Rezoning Application Pursuant to
DeKalb County Zoning Ordinance

of

**Alderwood Capital Inc., d/b/a Mosaic Communities
c/o Battle Law, P.C.**

for

34.93± Acres of Land on Norman Road
Being Tax Parcel Nos. 18 095 03 005, 18 095 03 006, 18 095 03 008,
18 095 03 090, 18 095 03 009 & 18 095 03 094
Unincorporated DeKalb County, Georgia

Submitted for Applicant by:

Michèle L. Battle, Esq.
Battle Law, P.C.
One West Court Square, Suite 750
Decatur, Georgia 30030
(404) 601-7616 Phone
(404) 745-0045 Facsimile
mlb@battlelawpc.com

I. STATEMENT OF INTENT

The Applicant, Alderwood Capital Inc., d/b/a Mosaic Communities, is seeking to develop a 228-home mixed-housing type conservation community on 34.93 acres of land, being Tax Parcel Nos. 18 095 03 005, 18 095 03 006, 18 095 03 008, 18 095 03 090, 18 095 03 009 & 18 095 03 094 located on Norman Road (the “Subject Property”). The proposed residential project is comprised of cottage houses and two/three family homes. The Subject Property is currently zoned R-85, with a land use designation of suburban (SUB). The Applicant is seeking to rezone the Subject Property to RSM for the development of the community at a density of 6.53 units per acre (the “Project”).

PROJECT INFO	
UNITS	
1 - BEDROOM ADU HOMES:	6
1 - BEDROOM HOMES:	58
2 - BEDROOM HOMES:	82
3 - BEDROOM HOMES:	27
TOWNHOUSE HOMES:	55
TOTAL HOMES:	228
PARKING	
OFF-STREET:	308 (APP. 285 W/ GARAGES)
ON-STREET:	80
TOTAL PARKING:	388 (APP. 365 W/ GARAGES)

For the past 157 years, the Spivey family has owned the Subject Property. In fact, many surrounding neighbors live in housing developments that were part of the original Spivey farm. Three years ago, Hugh Spivey, the last member of the Spivey family to live on the Subject Property, passed away. With his passing, the family knew that the future of the Subject Property would have to change. They began to lay the groundwork for a vision of a conservation community respectful of their family’s legacy that maintains the Subject Property’s pastoral charm, preserves the original 1860s Spivey family log cabin, and revitalizes the 7.5 acre lake that the Spiveys grew up on.

Mosaic Communities and its architects at Kronberg Urbanists Architects are aiming to transform the Subject Property into a walkable, community-oriented pocket neighborhood that incorporates the Spivey’s vision and that of DeKalb County’s Comprehensive Plan + Memorial Drive Revitalization Plan. The Project will be a conservation community that respects the natural landscape, with over 50% of the Subject Property to remain preserved and untouched. The remaining acreage will be amenitized and built out with clusters of upscale cottage homes + two/three family homes inspired by the Spivey family’s historical log cabin.

The Applicant plans to make improvements to the beautiful Hugh Spivey Lake for residents to better appreciate and enjoy the Subject Property’s idyllic setting. Additional amenities include a community garden, community forest, community plaza, dog park, tot lot, cottage court courtyards, and over 3 miles of walking trails/sidewalks. It is also important to Mosaic and the Spivey family that the Project be energy efficient and sustainable, which Mosaic intends to achieve by utilizing energy efficient appliances and building materials, on-site food production, a site plan that consumes less infrastructure and resources, and renewable energy.

The Project also aims to create community and a true sense of place, both essential in today's increasingly isolated world. According to the National Institute of Health, 3 in 5 Americans were lonely prior to COVID-19. This is partly due to our built environment. Humans are social by nature; we like to live around others. Single family development over the last half century has overshot our desire for privacy, leaving many people isolated on their own islands amidst a sea of houses and garages. We can do better. Research shows the physical and social qualities of a neighborhood impact well-being and mental health. Mosaic aims to build on this principle by organizing community events, providing resident move-in support, creating a dedicated community mobile app, and organizing volunteer opportunities. These efforts will be cultivated by an on-site property manager and resident life coordinator.

Owning a home demands substantial maintenance and upkeep while requiring a skill-set fewer and fewer Americans possess and time they are not willing to give. Nearly a third of Millennials don't own a hammer, a tool owned by 93% of Baby Boomers. Each generation is becoming increasingly less handy and able to manage DIY emergencies. Americans are also working later in life, leaving less time for home repairs and upkeep. Americans aged 65 or older are twice as likely to be working today as compared with 1985. Furthermore, from e-commerce and smart devices to meal delivery kits and ride hailing apps, Americans have shown a clear preference for convenience. Leasing a home is increasingly becoming a lifestyle choice for those looking for a hassle-free living experience without landscaping, maintenance, and repairs. With an on-site maintenance technician and property manager, the Project will cater to such households as well as those who choose to rent for other reasons such as a desire to downsize, move away from traditional apartment living, cultivate community, create an anchor to the area, etc.

This document is submitted both as a Statement of Intent and Impact Analysis with regard to this Application, a preservation of the Applicant's constitutional rights, and the Impact Analysis. A surveyed plat and conceptual site plan of the Subject Property controlled by the Applicant has been filed contemporaneously with the Application, along with other required materials.

II. IMPACT ANALYSIS

- (a) *Whether the zoning proposal is in conformity with the policies and intent of the land use plan;*

The proposed zoning designation of RSM is in conformity with the policies and intent of the DeKalb County 2035 Comprehensive Plan Future Land Use Map, as the land use designation will remain suburban (SUB). The Project also supports the goals of the Memorial Drive Revitalization Plan, which the Subject Property is within the area of influence. The Memorial Drive Plan is centered on three core strategies, all of which are reflected in the vision for the Project: change the perception, create demand, and encouraging healthy redevelopment. A handful of excerpts from the Memorial Drive Plan that sync up with the Project are listed below.

CHANGE THE PERCEPTION	CREATE DEMAND	ENCOURAGE HEALTHY REDEVELOPMENT
<p>“Initiatives needed to help people rethink perceptions”</p> <p>“Walkable, civically engaging”</p> <p>“See the corridor in a different light”</p> <p>“The area needs a rebranding”</p> <p>“Incremental victories needed to help revitalize the area”</p>	<p>“Generate a buzz and energy about the area”</p> <p>“Support the creation of ‘experiences’ through amenitization of the area”</p> <p>Household growth needed to drive positive transformation</p> <p>“Encourage trail and active mode networks”</p>	<p>“Revitalization not gentrification”</p> <p>“Creating a positive regulatory environment receptive to private sector efforts”</p> <p>To support redevelopment, “it is appropriate to change the comprehensive plan designation and zoning for individual properties”</p>

(b) *Whether the proposed zoning will be a use that is suitable in view of the use and development of adjacent and nearby property;*

The proposed conservation community is suitable for the area. The property is located in a residential community single family residential and zoned R-85. The proposed zoning designation of RSM would allow for a slightly higher density, but will remain consistent with the residential aspect of adjacent properties and within the Suburban land use category. All homes will be single family scale, include no more than two stories, and be properly distanced from existing residences to not encumber occupants’ quality of life.

(c) *Whether the subject property has a reasonable economic use as currently zoned;*

The Subject Property has marginal use as currently zoned due to the development costs associated with the Subject Property (floodplains, lake maintenance, topography, large lot and home size requirements, lack of existing usable infrastructure, etc.) The value of the Subject Property is significantly diminished by its current zoning restrictions. There is a lake located on the Subject Property which, while beautiful and a significant asset to the community, limits the usable acreage. There are also substantial floodplains. The cost of the land, however, along with construction costs on a challenging site such as the Subject Property demand creative layouts, greater density, and the clustering of homes to allow for a development that will support revitalization without gentrification, a key tenant of the Memorial Drive Revitalization Plan. The existing RS-85 zoning designation would allow fewer homes at prices unattainable for the surrounding area, consume more resources due to its inefficient land use, and likely involve a traditional developer coming in and clear-cutting the trees & constructing oversized suburban tract homes that 1) do not match the surrounding demographics (over 75% of households within a 3 mile radius of the Subject Property are 1, 2, or 3 person households) and 2) cater to garages and automobiles versus humans. The

Subject Property is a unique site, with a unique history, and warrants unique consideration from a zoning and land use standpoint.

- (d) *Whether the proposed zoning will adversely affect the existing use or usability of adjacent or nearby property;*

The proposed conservation community is suitable for the area and will have a positive effect on adjacent properties. The Project will be an asset to the greater community through its 3+ miles of trails/sidewalks, lake improvements and access, and community events. The Applicant will allow and encourage the existing farm/organic garden to remain on the Subject Property. Additionally, the Project will preserve a large amount of the natural landscape and the Spivey family's historic log cabin, which are both important to the greater community.

The Project will have a positive impact as it will support the growth and development of the surrounding area. Additionally, the introduction of new, quality housing and enhanced amenities will help raise property values within the surrounding residential communities. If the Project's homes were sold to individual homebuyers, they would surely set a new high in terms of pricing (as measured on a \$/Sq Ft basis). New development is needed in the area in order to bring new residents and support the revitalization of Memorial Drive + downtown Clarkston. Part of the challenge in the surrounding neighborhood is that current homeowners tend to age in place, leaving little opportunity for prospective residents to relocate to the area. Adding households to the community will help spur population growth and increased tax revenues, all of which will support existing local businesses as well as bring in new retail and commercial.

The current (2020) property tax bill for the combined six parcels is just south of \$10,000. Furthermore, since these will be rental homes, there will be no homestead exemptions, frozen exemption, and/or e-host credits typically offered to owner-occupied homes. Mosaic estimates that after its development is built out and stabilized, property tax revenues for the County may reach north of \$500,000 per year depending on the final number of homes.

Therefore, based upon the foregoing, the proposed rezoning will not adversely affect the existing use or usability of adjacent or nearby properties. The proposed use is consistent with the surrounding residential uses, and may add additional amenities for the enjoyment of nearby residents. Furthermore, the additional tax revenue for the County may provide additional resources to support adjacent infrastructure and future multi-modal connectivity.

- (e) *Whether the zoning proposal will result in a use which will or could cause an excessive or burdensome use of existing streets, transportation facilities, utilities, or schools; and*

The proposed use will not cause any excessive or burdensome use on the existing streets, transportation facilities, utilities or schools in the area. Target residents for the Project will be smaller households primarily comprised of the Baby Boomer, Millennial, and older Gen-Z demographic cohorts. Such households include few children and therefore place a minimal burden on the school system.

- (f) *Whether there are other existing or changing conditions affecting the use and development of the property which give supporting grounds for either approval or disapproval of the zoning proposal.*

How people live is changing. When the Spivey family built many of the existing subdivisions surrounding the proposed community, the world was a very different place. Suburban living was touted as being the answer to congested urban living environments, with large lot developments, large homes, and plenty of distance between houses. To live in suburbia meant having all of the latest household goods, and you definitely needed a car, because living in suburbia was about commuting to work. In fact, in DeKalb County, sidewalks were almost unheard of except in commercial areas. Most subdivisions were built with no sidewalks and little consideration for infrastructure such as stormwater detention, stream buffers, etc. The lesson learned from the golden era of suburban subdivisions is that all that glitters isn't gold. Many of the challenges suburban communities are facing in terms of traffic congestion, stormwater runoff issues, and marginally walkable communities stems from the unforeseen consequences of the suburban experience.

The proposed community is in line with what future growth and development in suburban areas should look like. We are proposing a community that has a mixture of residential uses that addresses the needs of individuals who are not interested in homeownership and do not want to live in an apartment, but are also not interested in renting out a single-family home that doesn't have the walkability, sense of community or environmental preservation that the proposed community will offer.

There are some who say that this is not the right location, but we challenge that position as Spivey Lake is an oasis in the middle of a typical suburban community. The Project deserves more than just a cookie-cutter residential subdivision. The Applicant is seeking to develop a community that will attract households with income levels between \$55,000.00 and \$75,000.00. These individuals will be seeking an alternative living experience in an area near the Memorial Drive corridor that DeKalb County is seeking to reinvigorate. These residents will support the County's push to bring new retailers and restaurants into the area as it shows new growth and development at higher income levels. More of the same will bring more of the same. If the redevelopment of Memorial

III. CONCLUSION

For the foregoing reasons, the Applicant respectfully requests that the Rezoning Application at issue be approved. The Applicant also invites and welcomes any comments from Staff or other officials of DeKalb County so that such recommendations or input might be incorporated as conditions of approval of this Application. Please note that the Applicant's Notice of Constitutional Allegations and Preservation of Constitutional Rights has been submitted with this Application and are attached hereto and by this reference incorporated herein.

This 28th day of April, 2021.

Respectfully submitted,



Michèle L. Battle, Esq.
Attorney For Applicant

Campaign Contribution Disclosure Statements
Last Updated 2/24/2021

CAMPAIGN CONTRIBUTIONS DISCLOSURE STATEMENT

Pursuant to the provisions of 36 O.C.G.A. 67(A), please find below a list of those contributions made by Michèle L Battle or Battle Law, P.C. in the past two years, aggregating \$250.00 or more, to local government officials who will consider this application.

NAME OF GOV'T OFFICIAL	OFFICIAL POSITION	AMOUNT OF CONTRIBUTION
Ted Terry	Commissioner	\$500
Mereda Davis Johnson	Commissioner	\$250

By: 
Printed Name: Michele L. Battle

TRAFFIC IMPACT STUDY FOR

SPIVEY LAKE RESIDENTIAL DEVELOPMENT

DATE:

April 28, 2021

LOCATION:

DeKalb County, Georgia

PREPARED FOR:

Mosaic Communities

PREPARED BY:

NV5 Engineers and Consultants, Inc.
1255 Canton Street, Suite G
Roswell, GA 30075

EXECUTIVE SUMMARY

A new residential development is proposed for construction along Norman Road in DeKalb County, Georgia. The proposed development will consist of 40 single family homes, 138 two-family homes, and 52 townhomes. The development has a projected build out date of 2024 and will generate a total of 1,844 new daily trips. Of these daily volumes, 121 (28 entering and 93 exiting) are expected to occur in the AM peak hour while 147 (92 entering and 55 exiting) are expected to occur in the PM peak hour.

The development will contain two (2) full access points along Norman Road and one (1) access point as an extension of Spartan Lane.

Existing intersections adjacent to the planned development were evaluated to determine if new roadway geometries or traffic controls will be needed once the development is built.

The following intersections were evaluated in this study:

1. Otello Avenue/Driveway 1 & Norman Road
2. Driveway 2 & Norman Road
3. Norman Road & Rays Road
4. Spartan Lane & Rays Road
5. Rays Road & Memorial Drive

The analysis uses adjustment factors applied to existing traffic counts as a baseline condition to account for the decrease in traffic due to the COVID-19 pandemic. Under baseline conditions, all intersections operate at a level of service (LOS) "D" or better at each approach.

No-Build conditions for this study show that the assumed 3.4% growth rate does not have a significant effect on the study network. With the increased growth, the intersections do increase in delay (as expected) and only two approaches increase in overall LOS compared to baseline conditions. All intersections continue to operate satisfactorily at an overall LOS D or better.

The additional project trips from the Spivey Lake Residential Development do not significantly affect the study network. With the added trips, the intersections do increase in delay (as expected), but do not change the overall levels of service experienced in the No-Build conditions.

Based on GDOT criteria, the eastern site driveway (Driveway 2) for the development warrants a right-turn deceleration lane. However, the installation of the turn lane is at the discretion of DeKalb County.

Based on the analysis prepared for the proposed development, improvements at the study intersections are not required to mitigate the impact of the proposed development.

TABLE OF CONTENTS

A.	Introduction.....	1
B.	Existing Conditions	4
B.1.	Transportation Facilities	4
B.2.	Traffic Counts	4
B.3.	Baseline Adjustment	6
C.	Future Conditions	8
C.1.	Background Data Collection	8
C.2.	Project Trip Generation	8
C.3.	Trip Distribution and Assignment.....	10
D.	Traffic Impact Analyses	14
D.1.	2021 Existing Capacity Analysis.....	14
D.2.	2021 Baseline Capacity Analysis.....	15
D.3.	2024 No-Build Capacity Analysis	16
D.4.	2024 Build Conditions Capacity Analysis	17
E.	GDOT Turn Lane Evaluations	18
F.	Conclusions.....	19

Appendix

LIST OF TABLES

Table 1:	Project Trip Generation	8
Table 2:	2021 Existing Capacity Analysis.....	14
Table 3:	2021 Baseline Capacity Analysis	15
Table 4:	2024 No-Build Capacity Analysis	16
Table 5:	2024 Build Capacity Analysis	17
Table 6:	GDOT Turn Lane Evaluations.....	18

LIST OF FIGURES

Figure 1.	Vicinity Map	2
Figure 2.	Site Location Aerial	3
Figure 3:	Existing Volumes (2021).....	5
Figure 4:	Baseline Volumes (2021).....	7
Figure 5:	2024 No-Build Traffic Volumes	9
Figure 6:	Trip Distribution	11
Figure 7:	Project Development Trips	12
Figure 8:	2024 Build Traffic Volumes.....	13

A. Introduction

A new residential development is proposed for construction along Norman Road in DeKalb County, Georgia. The proposed development will consist of 40 single family homes, 138 two-family homes, and 52 townhomes.

This traffic study analyzes the impact of new traffic added to the local roadways upon the occupancy of the residential development.

This study includes analysis of the Existing and Baseline Conditions, No-Build Conditions (including background growth and expected traffic from adjacent/nearby developments), and Build Conditions at the following intersections:

1. Otello Avenue/ Driveway 1 & Norman Road
2. Driveway 2 & Norman Road
3. Norman Road & Rays Road
4. Spartan Lane & Rays Road
5. Rays Road & Memorial Drive

The report summarizes background and projected traffic at the study locations, analysis of traffic impacts including level of service (LOS) and conclusions and recommendations from the analysis.

Figure 1 depicts the site location in DeKalb County. The study intersections listed above are depicted in Figure 2. A copy of the development concept plan is included in the Appendix.

Figure 1. Vicinity Map

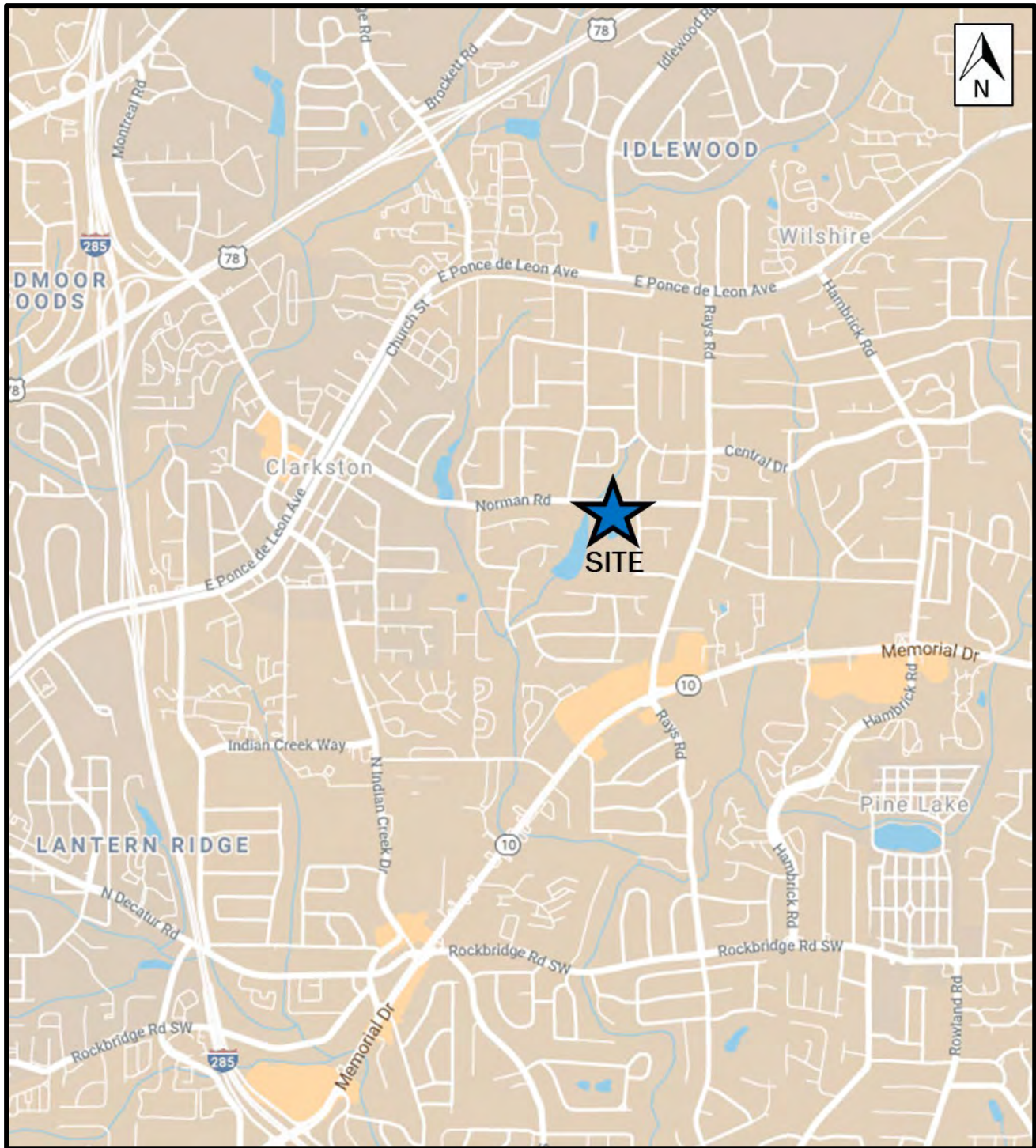
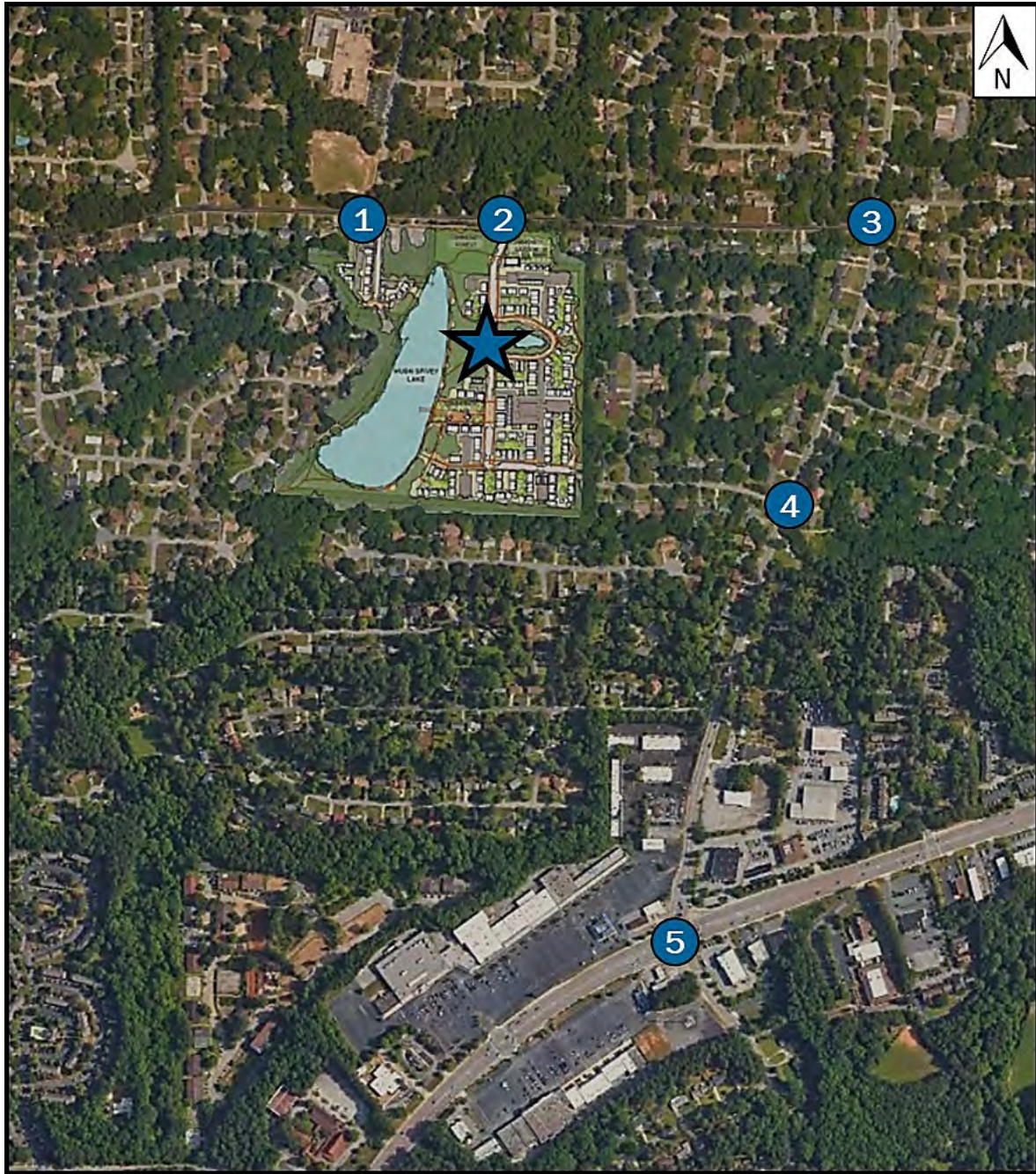

Figure 2. Site Location Aerial



1. Otello Avenue/ Driveway 1 & Norman Road
2. Driveway 2 & Norman Road
3. Norman Road & Rays Road
4. Spartan Lane & Rays Road
5. Rays Road & Memorial Drive

B. Existing Conditions

B.1. Transportation Facilities

Norman Road is an east-west, two-lane undivided, collector roadway with a posted speed of 35 MPH. The road is in a school zone beginning 0.2 mile west of its intersection with Otello Avenue and ending 0.1 mile east of said intersection. The roadway facilitates access to primarily residential land. The roadway will service two access points for the subject development.

Otello Road is a north-south, two-lane undivided, local roadway with a posted speed of 25 MPH. Jolly Elementary School is located along the roadway 400 feet north of its intersection with Norman Road. Northbound traffic is prohibited from 7:15 AM to 8:15 AM and 1:45 PM to 2:45 PM. Land uses along the roadway are residential and institutional.

Spartan Lane is an east-west, two-lane undivided, local residential roadway with a posted speed of 25 MPH. The roadway will service one access point for the subject development.

Rays Road is a north-south, two-lane undivided, collector roadway with a posted speed of 35 MPH. The roadway provides access to Memorial Drive approximately one mile south of its intersection with Norman Road. The roadway facilitates access to primarily residential land uses with commercial/retail land uses surrounding Memorial Drive. Rays Road has an AADT of about 10,700 vehicles per day near the study intersection.

Memorial Drive (SR-10) is a six-lane, major arterial roadway with a posted speed of 45 MPH. The roadway provides access to I-285 approximately two miles southwest of its intersection with Rays Road. There are a plethora of land uses along the roadway within the vicinity of the project including commercial/retail, institutional, medical, and residential. Memorial Drive has an AADT of about 40,800 vehicles per day near the study intersection.

B.2. Traffic Counts

Weekday peak period turning movement counts were collected at the existing intersections depicted in Figure 2 on Thursday, March 25, 2021 while schools were in session. Bi-directional traffic counts were also collected on Norman Road near the site on Thursday, March 25, 2021. The daily traffic recorded along Norman Road was 2,446 vehicles. The turning peak hour counts at the study intersections are shown in Figure 3 (Existing Traffic Volumes). The count worksheets are included in Appendix B.

Figure 3: Existing Volumes (2021)

##(##) → AM (PM) Peak Hour Traffic Volume
 - - - Proposed Driveway

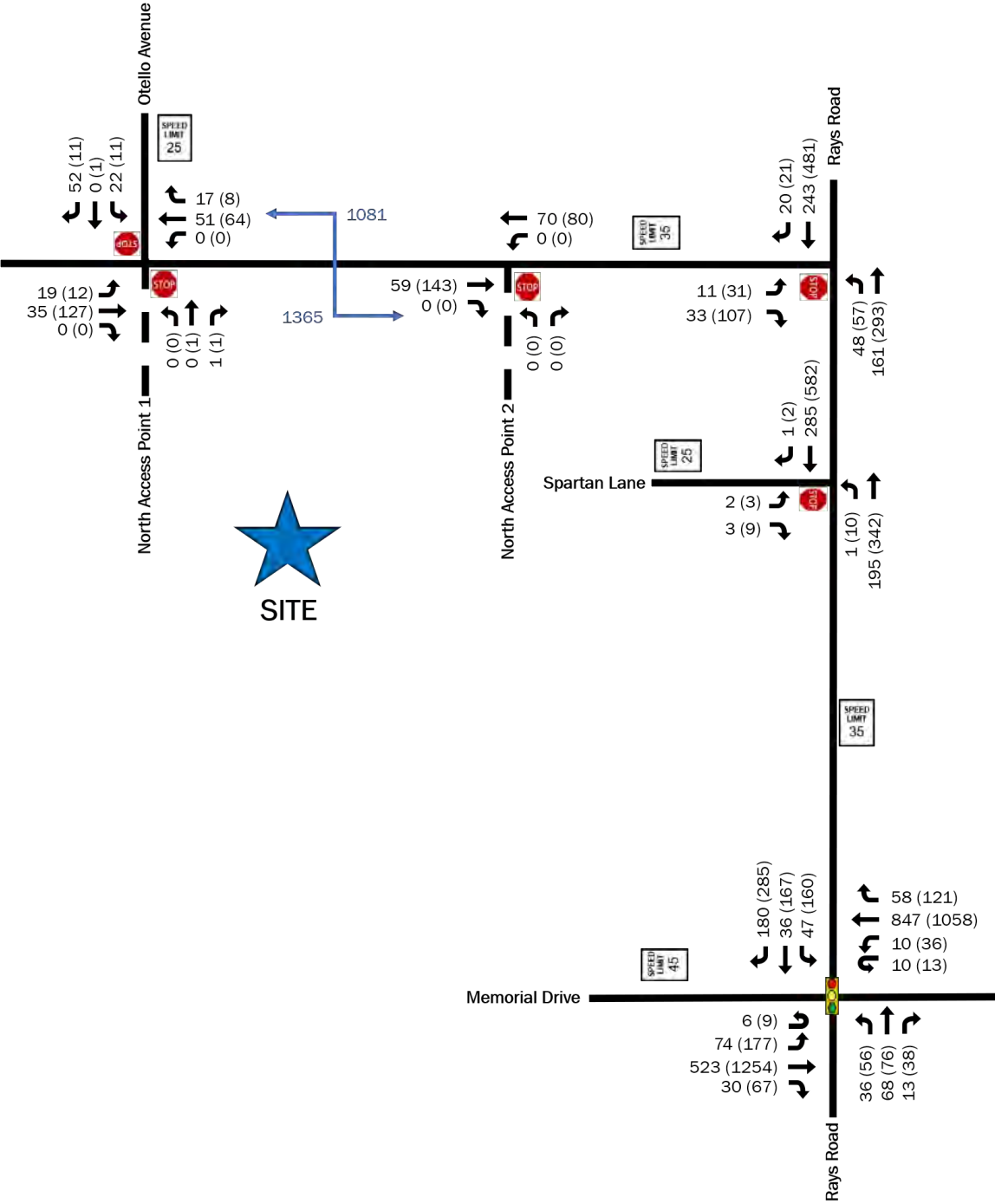

B.3. Baseline Adjustment

The analysis utilizes an adjustment factor to account for the decrease in traffic due to the COVID-19 pandemic. The factors were developed using counts from the Georgia Department of Transportation's (GDOT) Automated Traffic Signal Performance Measures (ATSPM). Turning movement counts recorded at the intersection of Memorial Drive (SR 10) and Rays Road in March 2019 were compared to counts recorded in March 2021 at the same intersection. From the data, the analysis uses a factor of 1.4 applied to the AM peak hour counts and a factor of 1.05 applied to the PM peak hour counts at each of the study intersections depicted in Figure 2. The adjusted volumes (Baseline Volumes) are depicted in Figure 4. The No-Build and Build scenarios in the study utilize these volumes as baseline conditions. The adjustment factor worksheet and supporting data are included in Appendix B.

Figure 4: Baseline Volumes (2021)

##(##) → AM (PM) Peak Hour Traffic Volume
 - - - Proposed Driveway

NOT TO SCALE

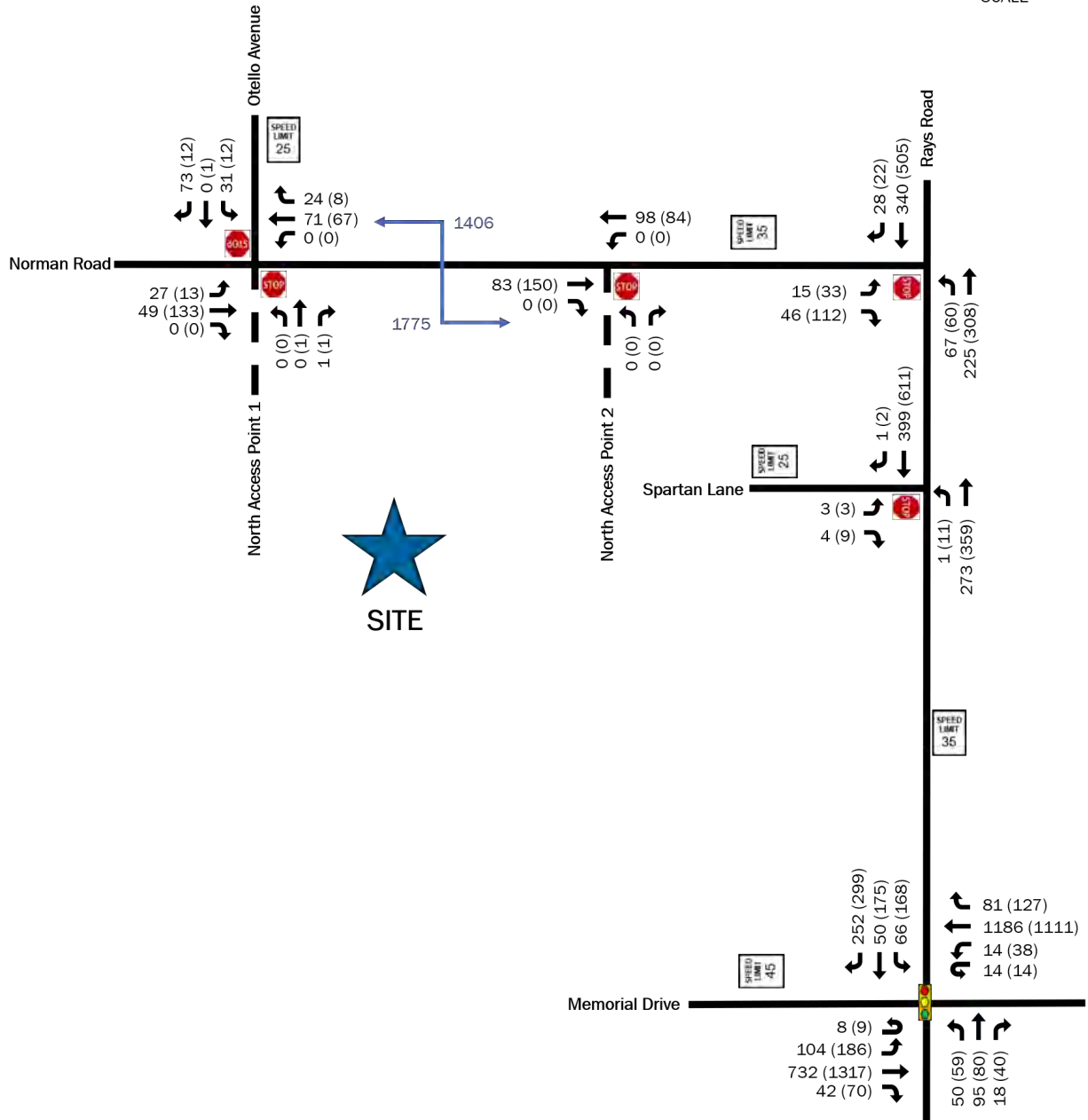

C. Future Conditions

C.1. Background Data Collection

The growth rate in the study area is based upon an analysis of historical traffic counts collected by the Georgia Department of Transportation (GDOT). The project is expected to be built-out in 2024. To account for ambient growth in the area, the baseline traffic counts were grown by 3.4% per year for three years. The growth rate considers historical GDOT traffic data collected along Rays Road, Memorial Drive, and Ponce de Leon Avenue. The expected volumes are depicted in Figure 5, 2024 No-Build Volumes. The historical counts and growth rate development worksheet are included in Appendix B.

C.2. Project Trip Generation

Table 1 summarizes the project trip generation calculated using the Institute of Transportation Engineers' (ITE) Trip Generation Manual, 10th Edition, 2017. The community consists of three types of dwelling units including 138 Two-Family Homes, 52 Townhomes, and 40 Single Family Detached Homes. The homes encompass two types of ITE Land Use Codes (LUC) including one for the single-family detached homes (LUC 210) and one for both the two-family home unit type and the townhome unit type (LUC 220). Table 1 below summarizes the daily and hourly trip generation of the proposed residential development. The scale of the project does not warrant trip reductions for pass-by and/or internal capture. Conservatively, the analysis does not consider reduced, generated trips to account for transit/multimodal use.

Table 1: Project Trip Generation

LAND USE	PERIOD	TOTAL	IN	OUT
Single Family Homes, LUC 210 (40 Dwelling Units)	Daily	448	224	224
	AM Peak Hour	33	8	25
	PM Peak Hour	42	26	16
*Two/Three Family Homes (190 Dwelling Units - 138 Two-Family Homes, 52 Townhomes)	Daily	1,396	698	698
	AM Peak Hour	88	20	68
	PM Peak Hour	105	66	39
Total Net Trips	Daily	1,844	922	922
	AM Peak Hour	121	28	93
	PM Peak Hour	147	92	55

*Study utilizes ITE (Institute of Transportation Engineers) Land Use Code *Multi-Family Housing Low-Rise (LUC 220)*

Figure 5: 2024 No-Build Traffic Volumes

###(##) → AM (PM) Peak Hour Traffic Volume
 - - - Proposed Driveway



NOT TO SCALE

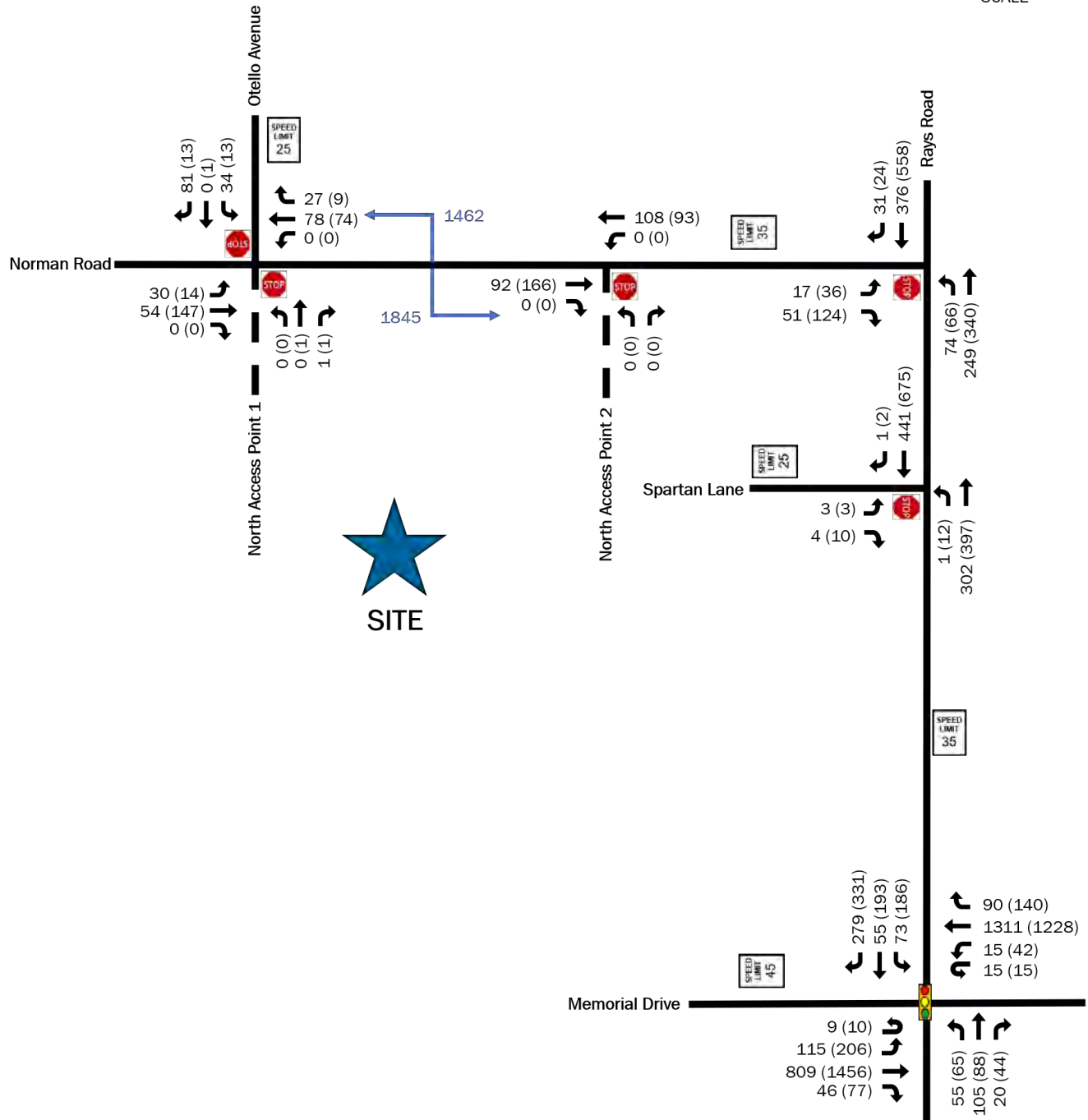

C.3. Trip Distribution and Assignment

The distribution and assignment of project trips for the development is based on an evaluation of traffic patterns typical of a residential development in addition to traffic patterns within the area, alongside an analysis of the collected traffic counts. Approximately 12% of the newly generated trips are expected to utilize Driveway 1 at Norman Road and Otello Avenue, 44% of the newly generated trips are expected to utilize Driveway 2 at Norman Road and the remaining 44% of the newly generated trips are expected to use Spartan Lane at Rays Road. An expected 34% of the generated trips will be distributed to/from the west via Norman Road, an estimated 18% of the newly generated trips will be distributed to/from the north via Rays Road. Approximately 48% of the newly generated trips will be distributed to/from the south via Memorial Drive. The trip generation is depicted in Figure 6. The project trips generated from the development utilize the trip distribution and are depicted in Figure 7. The No-Build plus project trips (Build Volumes) are depicted in Figure 8.

Figure 6: Trip Distribution

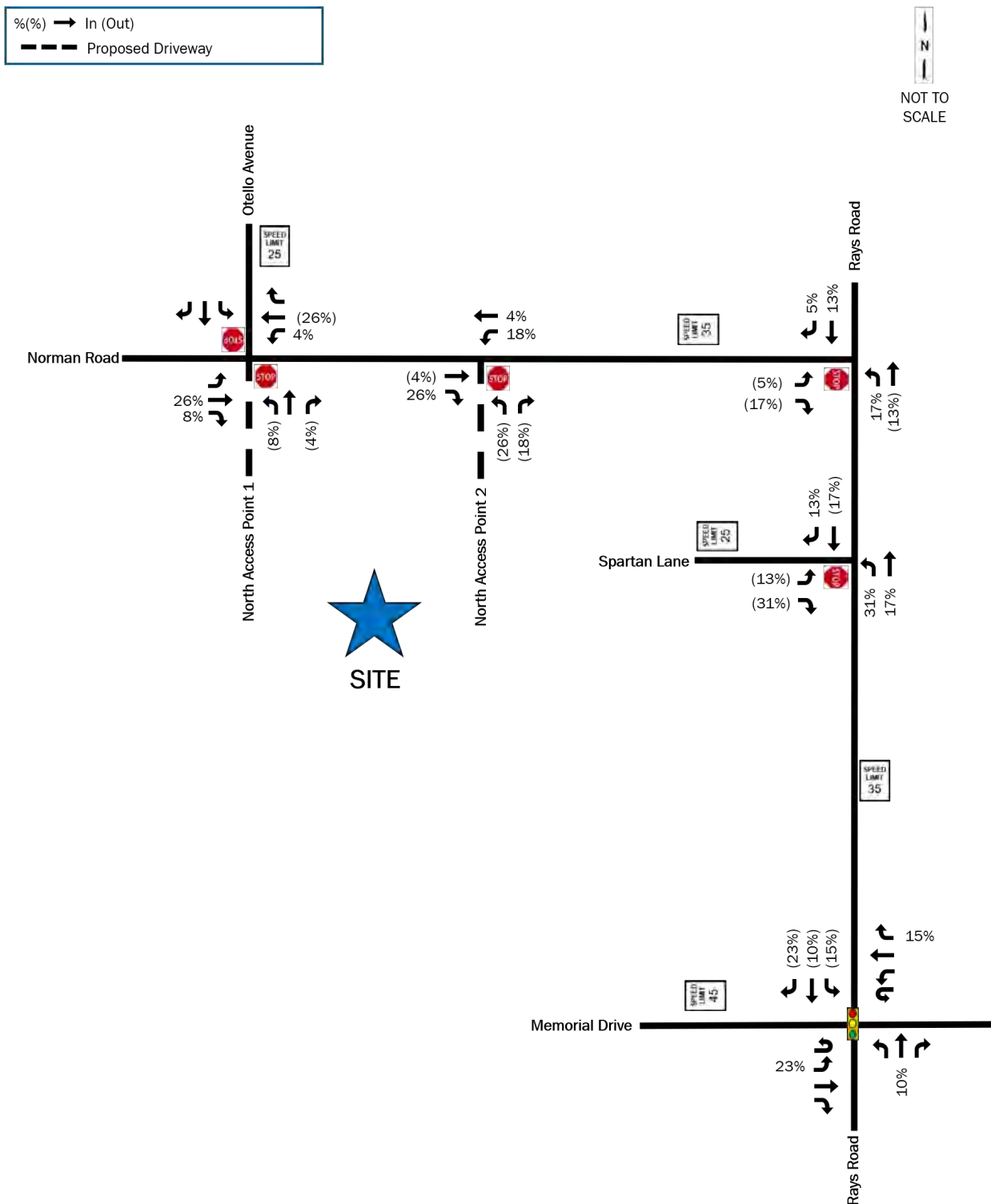
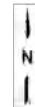

Figure 7: Project Development Trips

##(##) → AM (PM) Peak Hour Traffic Volume
 - - - Proposed Driveway

Trip Generation	Total	IN	OUT
AM Peak Hour	121	28	93
PM Peak Hour	147	92	55



NOT TO SCALE

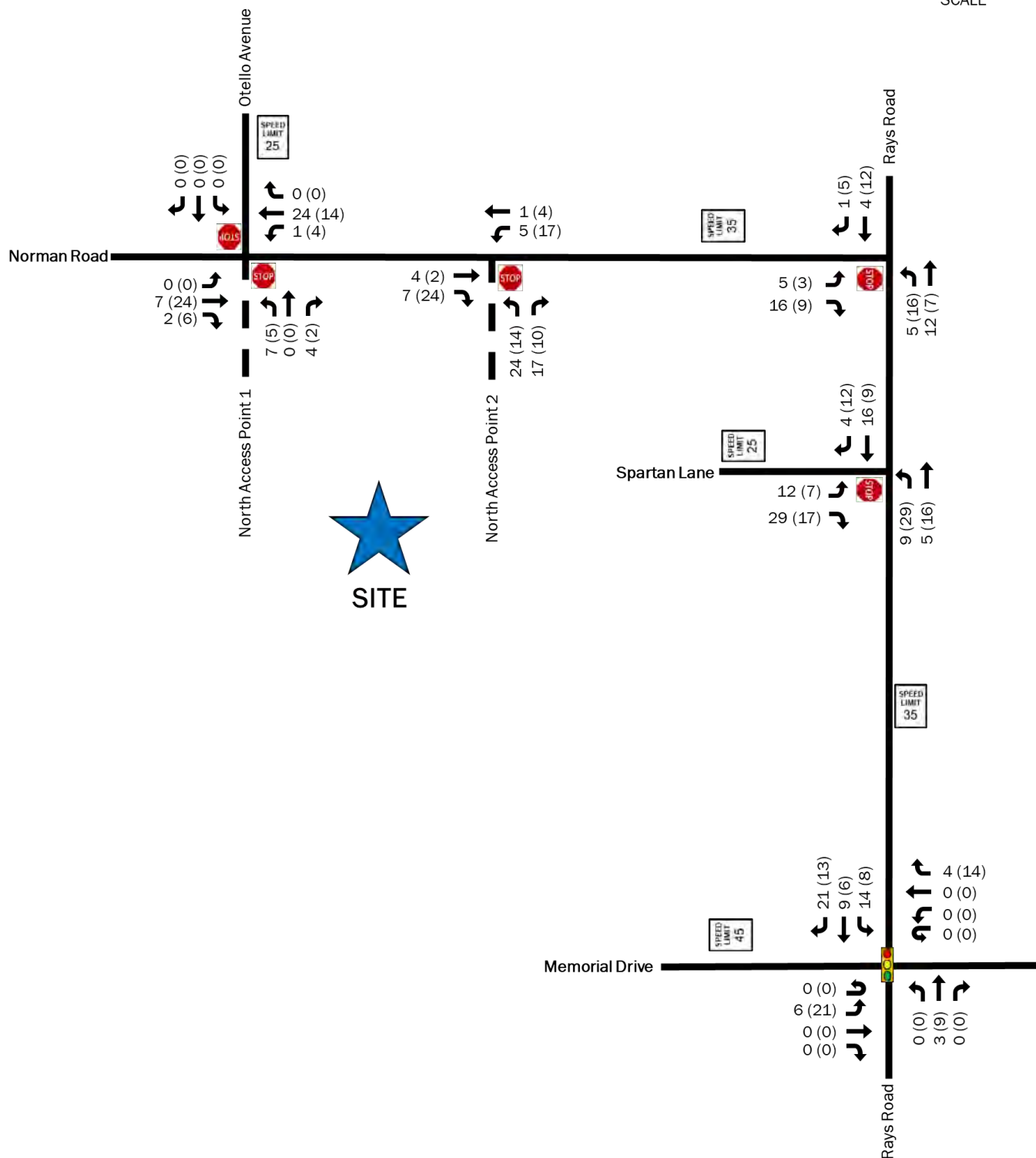
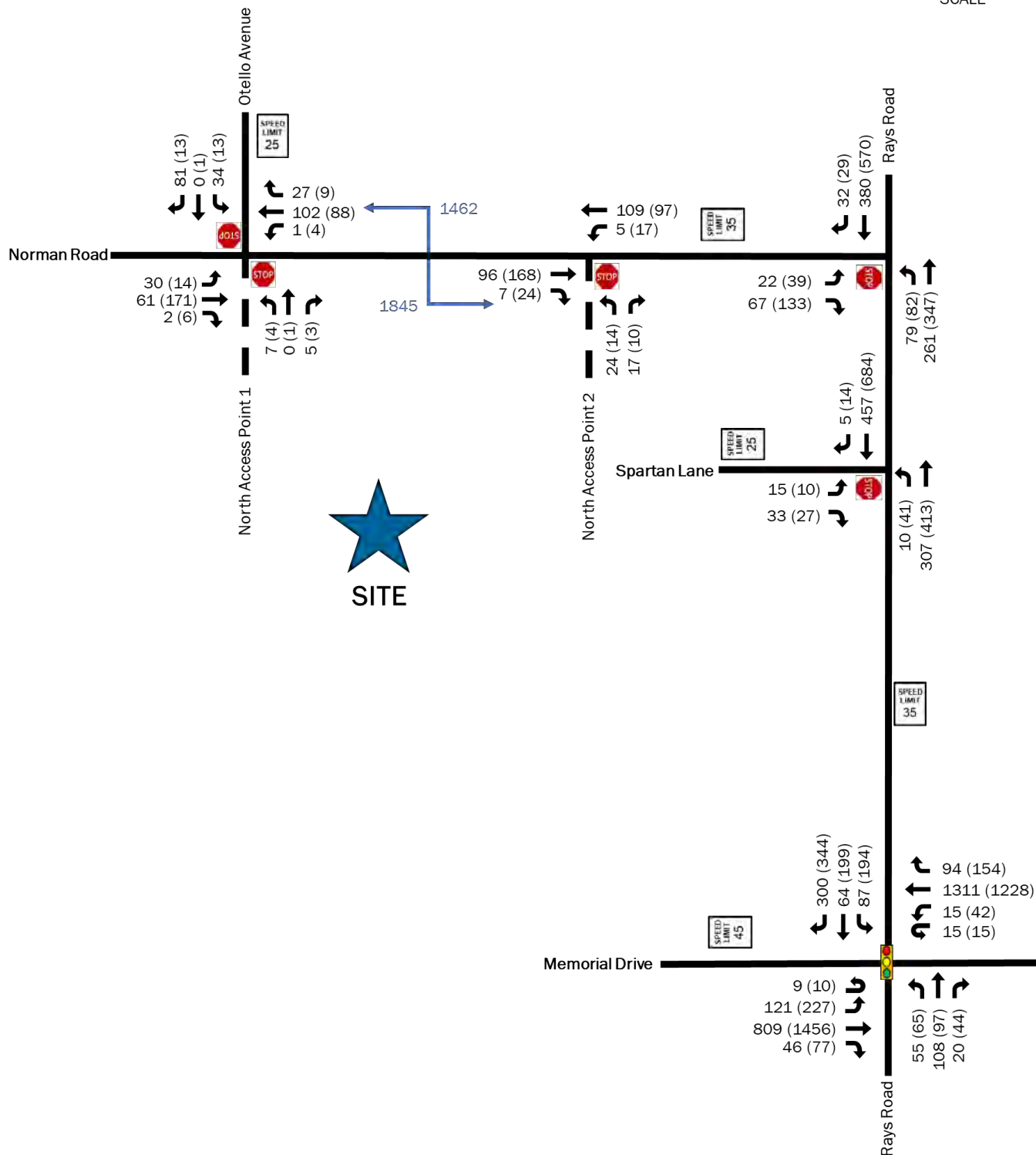

Figure 8: 2024 Build Traffic Volumes

##(##) → AM (PM) Peak Hour Traffic Volume
 - - - Proposed Driveway

↑ N ↓
 NOT TO SCALE



D. Traffic Impact Analyses

The analysis in each of the scenarios for the study was performed using the traffic analysis software Synchro® 11. The analysis utilizes optimized signal timing with assumed cycle lengths of 120 seconds in the AM and PM peak hours. Average vehicular delays are calculated and reported as Levels of Service (LOS) as defined by the Highway Capacity Manual (HCM 6th Edition). HCM uses a grading system from A through F, where A is best (little to no delay) and F is worst (very heavy delay). HCM level of service (LOS) standards and Synchro® output reports are included in Appendix C.

D.1. 2021 Existing Capacity Analysis

The results of the 2021 existing conditions capacity analysis are shown in Table 2 and include analysis of the volumes presented in Figure 3.

Table 2: 2021 Existing Capacity Analysis

ID	Intersection	Control	Movement	AM		PM	
				Delay	LOS	Delay	LOS
1	Dwy 1/Otello Rd & Norman Rd	Stop-Control	NB	8.5	A	9.8	A
			SB	9.6	A	9.6	A
			EBL	7.4	A	7.5	A
			WBL	-	-	-	-
2	DWY 2 & Norman Rd	Stop-Control	NB	-	-	-	-
			WBL	-	-	-	-
3	Rays Rd & Norman Rd	Stop-Control	EB	11.1	B	17.6	C
			NBL	8	A	8.7	A
4	Rays Rd & Spartan Ln	Stop-Control	EB	10.9	B	14.8	B
			NBL	7.9	A	8.9	A
5	Rays Rd & Memorial Dr	Signal	EB	24.9	C	29.4	C
			WB	27.9	C	29.7	C
			NB	16.9	B	24.5	C
			SB	23.5	C	33.9	C
			Overall	25.6	C	30.1	C

The study assumes adequate operations as LOS D or better. As shown in Table 2, the overall traffic operations at the study intersection are satisfactory in existing conditions.

D.2. 2021 Baseline Capacity Analysis

The results of the 2021 baseline conditions capacity analysis are shown in Table 3 and include analysis of the volumes presented in Figure 4.

Table 3: 2021 Baseline Capacity Analysis

ID	Intersection	Control	Movement	AM		PM	
				Delay	LOS	Delay	LOS
1	Dwy 1/Otello Rd & Norman Rd	Stop-Control	NB	8.6	A	9.8	A
			SB	10.2	B	9.6	A
			EBL	7.5	A	7.5	A
			WBL	-	-	-	-
2	Dwy 2 & Norman Rd	Stop-Control	NB	-	-	-	-
			WBL	-	-	-	-
3	Rays Rd & Norman Rd	Stop-Control	EB	13.0	B	18.9	C
			NBL	8.4	A	8.9	A
4	Rays Rd & Spartan Ln	Stop-Control	EB	12.5	B	15.4	C
			NBL	8.2	A	9.0	A
5	Rays Rd & Memorial Dr	Signal	EB	24.9	C	30.2	C
			WB	27.8	C	30.6	C
			NB	22.5	C	25.7	C
			SB	32.5	C	35.6	D
			Overall	27.2	C	31.1	C

The study assumes adequate operations as LOS D or better. As shown in Table 3, the overall traffic operations at the study intersection are satisfactory in baseline conditions.

D.3. 2024 No-Build Capacity Analysis

The results of the No-Build capacity analysis are shown in Table 4 and include analysis of the volumes presented in Figure 5.

Table 4: 2024 No-Build Capacity Analysis

ID	Intersection	Control	Movement	AM		PM	
				Delay	LOS	Delay	LOS
1	DWY 1/Otello Rd & Norman Rd	Stop-Control	NB	8.6	A	10.0	B
			SB	10.5	B	9.8	A
			EBL	7.5	A	7.5	A
			WBL	-	-	-	-
2	DWY 2 & Norman Rd	Stop-Control	NB	-	-	-	-
			WBL	-	-	-	-
3	Rays Rd & Norman Rd	Stop-Control	EB	14.1	B	23.0	C
			NBL	8.5	A	9.1	A
4	Rays Rd & Spartan Ln	Stop-Control	EB	13.2	B	16.7	C
			NBL	8.4	A	9.3	A
5	Rays Rd & Memorial Dr	Signal	EB	25.8	C	30.9	C
			WB	29.7	C	31.4	C
			NB	24.6	C	28.9	C
			SB	36.5	D	40.7	D
			Overall	29.1	C	32.7	C

As shown in Table 4, under No-Build conditions with the calculated growth rate of 3.4% in the area, the intersections operate adequately at overall acceptable levels of services. The intersections do increase in delay (as expected with the growth rate) with all intersections operating at a level of service (LOS) D or better overall and at each approach.

D.4. 2024 Build Conditions Capacity Analysis

The results of the 2024 Build conditions intersection capacity analysis are shown in Table 5 for No-Build plus project volumes (Figure 8).

Table 5: 2024 Build Capacity Analysis

ID	Intersection	Control	Movement	AM		PM	
				Delay	LOS	Delay	LOS
1	DWY 1/Otello Rd & Norman Rd	Stop-Control	NB	10.7	B	10.5	B
			SB	10.8	B	10.1	B
			EBL	7.6	A	7.5	A
			WBL	7.4	A	7.6	A
2	DWY 2 & Norman Rd	Stop-Control	NB	9.6	A	10.2	B
			WBL	7.4	A	7.7	A
3	Rays Rd & Norman Rd	Stop-Control	EB	14.9	B	26.6	D
			NBL	8.6	A	9.3	A
4	Rays Rd & Spartan Ln	Stop-Control	EB	14.0	B	20.0	C
			NBL	8.5	A	9.6	A
5	Rays Rd & Memorial Dr	Signal	EB	26.9	C	32.6	C
			WB	31.0	C	33.6	C
			NB	24.7	C	28.8	C
			SB	37.8	D	40.8	D
			Overall	30.4	C	34.3	C

As shown in Table 5, the overall traffic from the additional project trips from the Spivey Lake Residential Development do not significantly affect the study network. With the added trips, the intersections do increase in delay (as expected), but do not change the overall levels of service experienced in No-Build conditions.

E. GDOT Turn Lane Evaluations

The need for turn lanes was evaluated for both driveways along Norman Road and the existing intersection of Rays Road and Spartan Lane using methodologies from the Georgia Department of Transportation (GDOT) Access Manual. The results of the evaluation are summarized in Table 6. From the evaluation, given the amount of expected traffic at Driveway 2, a right-turn deceleration lane is recommended.

Table 6: GDOT Turn Lane Evaluations

ID	Intersection	Movement/ Turn Lane	GDOT Criteria met?
1	Driveway 1 / Otello Rd & Norman Rd	WBL	NO
		EBR	NO
2	Driveway 2 & Norman Rd	WBL	NO
		EBR	YES
4	Rays Rd & Spartan Ln	NBL	NO
		SBR	NO

F. Conclusions

A new residential development is proposed for construction along Norman Road in DeKalb County, Georgia. The proposed development will consist of 40 single family homes, 138 two-family homes, and 52 townhomes. The proposed development will generate a daily total of 1,844 trips with 121 trips (28 entering and 93 exiting) during the AM peak hour, and 147 trips (92 entering and 55 exiting) during the PM peak hour. The following are conclusions from the study:

- Traffic operations at the study intersections are satisfactory (LOS D or better) in existing and baseline conditions.
- The conditions are expected to increase in delay as evidenced in the No-Build scenario due to the anticipated growth in the study area. Even with anticipated growth, the intersections are expected to operate at a level of service (LOS) D or better overall and at each approach.
- The addition of project traffic is expected to have little impact on the traffic operations at the study intersections. No improvements are recommended because the impact is minimal.
- Based on GDOT criteria, the eastern site driveway (Driveway 2) for the development warrants a right-turn deceleration lane. However, the installation of the turn lane is at the discretion of DeKalb County.

Based on the analysis prepared for the proposed development, improvements at the study intersections are not required to mitigate the impact of the proposed development.

APPENDIX A: CONCEPT PLAN



UNIT TYPE	TOTAL
SINGLE-FAMILY HOME	40
TWO-FAMILY HOME	138
TOWNHOUSE	52
TOTAL	230

230 UNITS / 34.88 AC = 6.59 UNITS / AC

PARKING	TOTAL
90° SPACE	213
PARALLEL SPACE	108
GARAGE SPACE	54
TOTAL	375

375 TOTAL PARKING SPACES
 - 3 CLUBHOUSE SPACES
 - 10 COMMUNITY GARDEN SPACES
 = **362 RESIDENTIAL PARKING SPACES**

362 SPACES / 230 UNITS = 1.57 PARKING RATIO

- COTTAGE COURT COURTYARD
- TRAIL
- BUILDING



SITE STUDY ILLUSTRATIVE PLAN
HUGH SPIVEY LAKE



RESIDENTIAL PROGRAM

BLOCK	SINGLE-FAMILY / TWO-FAMILY	ADU	TOWN-HOUSE	TOTAL	OFF-STREET PARKING
PA-1	11	16	-	27	26
PA-2	-	-	11	11	12
PA-3	-	-	4	4	6
PA-4	-	-	6	6	14
PA-5	-	-	16	16	17
COURT 1	7	10	5	22	31
COURT 2	12	6	-	18	22
COURT 3	7	6	5	18	23
COURT 4	12	7	-	19	24
COURT 5	6	5	5	16	26
COURT 6	14	6	-	20	24
COURT 7	11	1	-	12	11
COURT 8	10	3	-	13	11
COURT 9	11	2	-	13	13
COURT 10	9	6	-	15	13
TOTAL	110	68	52	230	273

230 UNITS / 34.88 AC = 6.59 UNITS / AC

1-STORY UNITS: APP. 10% (24 UNITS)
 2-STORY UNITS: APP 90% (206 UNITS)

COMMUNITY GARDEN	TOTAL	CLUBHOUSE	TOTAL
AREA	0.64 AC	SF	1,400 SF
PARKING	10 SPACES	PARKING	3 SPACES

ON-STREET PARKING	TOTAL
PARALLEL SPACE	89

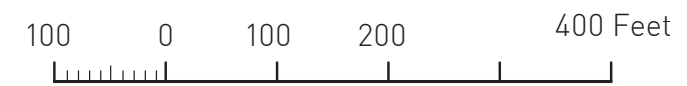

SITE STUDY CAPACITY DIAGRAM

HUGH SPIVEY LAKE



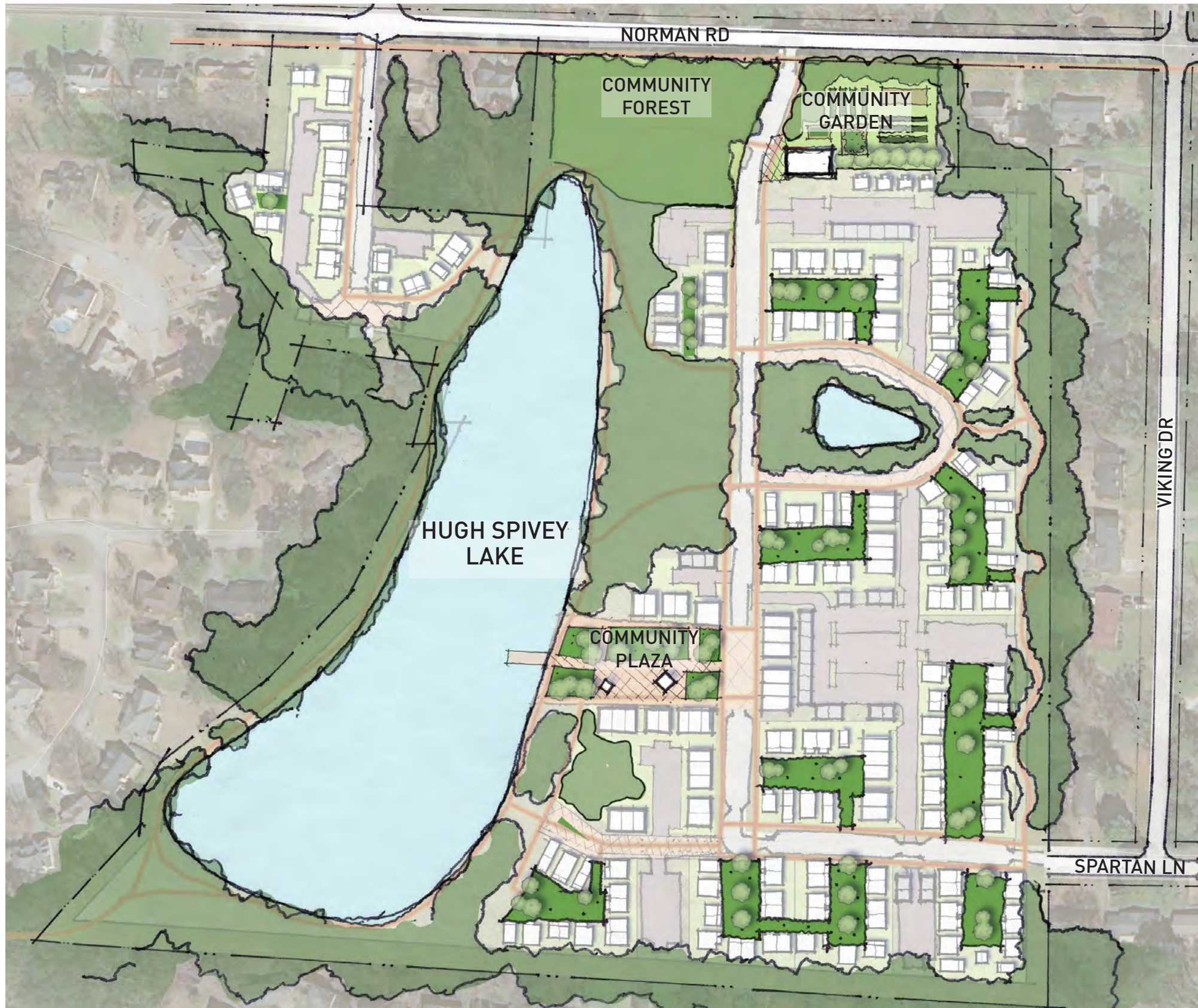

UNDEVELOPED LAND	TOTAL (AC)
TOTAL SITE AREA	34.88
TOTAL UNDEVELOPED AREA	18.00
18.00 AC UNDEVELOPED / 34.88 AC TOTAL = 51.6% OF LAND UNTOUCHED	

AREA OF COMMUNITY AMENITIES	TOTAL (AC)
COMMUNITY GARDEN	0.64
COMMUNITY FOREST	1.21
COMMUNITY PLAZA	0.65
COTTAGE COURT COURTYARDS	2.03
HUGH SPIVEY LAKE	7.00 AC
TOTAL	11.53 AC

TRAILS	TOTAL MILES
LINEAR DISTANCE OF TRAILS	2.1

- COTTAGE COURT COURTYARD
- TRAIL
- BUILDING



SITE STUDY GREEN SPACE DIAGRAM
HUGH SPIVEY LAKE

**APPENDIX B:
TRAFFIC COUNTS,
GROWTH RATE &
ADJUSTMENT FACTOR
WORKSHEETS**

Project ID: 21-180077-001
 Location: Otello Ave & Norman Rd
 City: Stone Mountain

Day: Thursday
 Date: 3/25/2021

Groups Printed - Cars, PU, Vans - Heavy Trucks

Start Time	Otello Ave Northbound						Otello Ave Southbound						Norman Rd Eastbound						Norman Rd Westbound						Int. Total
	Left	Thru	Rgt	Utum	Peds	App. Total	Left	Thru	Rgt	Utum	Peds	App. Total	Left	Thru	Rgt	Utum	Peds	App. Total	Left	Thru	Rgt	Utum	Peds	App. Total	
7:00 AM	0	0	0	0	0	0	8	0	10	0	0	18	7	6	1	0	14	0	7	10	0	17	49		
7:15 AM	0	0	0	0	0	0	8	0	23	0	0	31	3	7	0	0	10	0	17	5	0	22	63		
7:30 AM	0	0	1	0	2	1	6	0	11	0	0	17	6	12	0	0	18	0	15	1	0	16	52		
7:45 AM	0	0	0	0	3	0	0	0	8	0	0	8	3	10	0	0	13	0	12	1	0	13	34		
Total	0	0	1	0	5	1	22	0	52	0	0	74	19	35	1	0	4	55	0	51	17	0	0	68	198
8:00 AM	0	0	0	0	1	0	4	0	4	0	0	8	6	8	0	0	14	0	18	2	0	0	20	42	
8:15 AM	0	1	0	0	1	1	4	0	5	0	0	9	2	4	1	0	7	0	18	0	0	0	18	35	
8:30 AM	0	0	0	0	1	0	3	0	2	0	1	5	0	12	0	0	1	12	0	14	3	0	1	17	34
8:45 AM	0	0	0	0	1	0	1	0	2	0	0	3	5	10	0	0	15	1	15	3	0	0	19	37	
Total	0	1	0	0	4	1	12	0	13	0	1	25	13	34	1	0	2	48	1	65	8	0	1	74	148
BREAK																									
4:00 PM	0	0	0	0	1	0	3	0	2	0	0	5	1	25	0	0	2	26	0	18	1	0	0	19	50
4:15 PM	0	0	0	0	0	0	6	0	2	0	0	8	5	22	0	0	2	27	1	15	1	0	0	17	52
4:30 PM	0	0	0	0	0	0	6	0	1	0	0	7	3	25	0	0	0	28	0	13	2	0	0	15	50
4:45 PM	0	0	0	0	0	0	7	0	0	0	0	7	3	22	0	0	1	25	1	15	0	0	0	16	48
Total	0	0	0	0	1	0	22	0	5	0	0	27	12	94	0	0	5	106	2	61	4	0	0	67	200
5:00 PM	0	0	0	0	1	0	3	0	2	0	0	5	5	28	0	0	0	33	0	12	1	0	0	13	51
5:15 PM	0	0	0	0	4	0	2	1	4	0	0	7	3	30	0	0	2	33	0	20	5	0	2	25	65
5:30 PM	0	0	1	0	0	1	1	0	3	0	0	4	3	37	0	0	2	40	0	19	0	0	0	19	64
5:45 PM	0	1	0	0	0	1	5	0	2	0	0	7	1	32	0	0	0	33	0	13	2	0	0	15	56
Total	0	1	1	0	5	2	11	1	11	0	0	23	12	127	0	0	4	139	0	64	8	0	2	72	236
Grand Total	0	2	2	0	15	4	67	1	81	0	1	149	56	290	2	0	15	348	3	241	37	0	3	281	782
Apprch %	0.0	50.0	50.0	0.0	375.0	0	45.0	0.7	54.4	0.0	0.7	1	16.1	83.3	0.6	0.0	4.3	1	1.1	85.8	13.2	0.0	1.1	1	
Total %	0.0	0.3	0.3	0.0	1.9	0.5	8.6	0.1	10.4	0.0	0.1	19.1	7.2	37.1	0.3	0.0	1.9	44.5	0.4	30.8	4.7	0.0	0.4	35.9	
Cars, PU, Vans	0	2	2	0	4	4	58	1	73	0	0	132	55	286	2	0	343	3	229	36	0	0	268	747	
% Cars, PU, Vans	0.0	100.0	100.0	0.0	100.0	100.0	86.6	100.0	90.1	0.0	88.6	88.6	98.2	98.6	100.0	0.0	98.6	100.0	95.0	97.3	0.0	0.0	95.4	95.5	
Heavy trucks	0	0	0	0	0	0	9	0	8	0	0	17	1	4	0	0	5	0	12	1	0	0	13	35	
%Heavy trucks	0.0	0.0	0.0	0.0	0.0	0.0	13.4	0.0	9.9	0.0	11.4	11.4	1.8	1.4	0.0	0.0	1.4	0.0	5.0	2.7	0.0	0.0	4.6	4.5	

Project ID: 21-180077-001
 Location: Otello Ave & Norman Rd
 City: Stone Mountain

PEAK HOURS

Day: Thursday
 Date: 3/25/2021

AM

Start Time	Otello Ave Northbound						Otello Ave Southbound						Norman Rd Eastbound						Norman Rd Westbound						Int. Total
	Left	Thru	Rgt	Utum	Peds	App. Total	Left	Thru	Rgt	Utum	Peds	App. Total	Left	Thru	Rgt	Utum	Peds	App. Total	Left	Thru	Rgt	Utum	Peds	App. Total	
Peak Hour Analysis from 07:00 AM - 09:00 AM																									
Peak Hour for Entire Intersection Begins at 07:00 AM																									
7:00 AM	0	0	0	0	0	0	8	0	10	0	18	7	6	1	0	14	0	7	10	0	17	49			
7:15 AM	0	0	0	0	0	0	8	0	23	0	31	3	7	0	0	10	0	17	5	0	22	63			
7:30 AM	0	0	1	0	1	1	6	0	11	0	17	6	12	0	0	18	0	15	1	0	16	52			
7:45 AM	0	0	0	0	0	0	0	0	8	0	8	3	10	0	0	13	0	12	1	0	13	34			
Total Volume	0	0	1	0	1	1	22	0	52	0	74	19	35	1	0	55	0	51	17	0	0	68	198		
% App. Total	0.0	0.0	100.0	0.0	100	100	29.7	0.0	70.3	0.0	100	34.5	63.6	1.8	0.0	100	0.0	75.0	25.0	0.0	100	0.0	100	0.0	100
PHF	0.250						0.597						0.764						0.773						0.786
Cars, PU, Vans	0	0	1	0	1	1	17	0	45	0	62	19	32	1	0	52	0	45	16	0	61	176			
% Cars, PU, Vans	0.0	0.0	100.0	0.0	100.0	100.0	77.3	0.0	86.5	0.0	83.8	100.0	91.4	100.0	0.0	94.5	0.0	88.2	94.1	0.0	89.7	88.9			
Heavy trucks	0	0	0	0	0	0	5	0	7	0	12	0	3	0	0	3	0	6	1	0	7	22			
%Heavy trucks	0.0	0.0	0.0	0.0	0.0	0.0	22.7	0.0	13.5	0.0	16.2	0.0	8.6	0.0	0.0	5.5	0.0	11.8	5.9	0.0	10.3	11.1			

PM

Start Time	Otello Ave Northbound						Otello Ave Southbound						Norman Rd Eastbound						Norman Rd Westbound						Int. Total
	Left	Thru	Rgt	Utum	Peds	App. Total	Left	Thru	Rgt	Utum	Peds	App. Total	Left	Thru	Rgt	Utum	Peds	App. Total	Left	Thru	Rgt	Utum	Peds	App. Total	
Peak Hour Analysis from 04:00 PM - 06:00 PM																									
Peak Hour for Entire Intersection Begins at 05:00 PM																									
5:00 PM	0	0	0	0	0	0	3	0	2	0	5	5	28	0	0	33	0	12	1	0	13	51			
5:15 PM	0	0	0	0	0	0	2	1	4	0	7	3	30	0	0	33	0	20	5	0	25	65			
5:30 PM	0	0	1	0	1	1	1	0	3	0	4	3	37	0	0	40	0	19	0	0	19	64			
5:45 PM	0	1	0	0	1	1	5	0	2	0	7	1	32	0	0	33	0	13	2	0	15	56			
Total Volume	0	1	1	0	2	2	11	1	11	0	23	12	127	0	0	139	0	64	8	0	72	236			
% App. Total	0.0	50.0	50.0	0.0	100	100	47.8	4.3	47.8	0.0	100	8.6	91.4	0.0	0.0	100	0.0	88.9	11.1	0.0	100	0.0	100		
PHF	0.500						0.821						0.869						0.720						0.908
Cars, PU, Vans	0	1	1	0	2	2	11	1	11	0	23	11	126	0	0	137	0	62	8	0	70	232			
% Cars, PU, Vans	0.0	100.0	100.0	0.0	100.0	100.0	100.0	100.0	100.0	0.0	100	91.7	99.2	0.0	0.0	98.6	0.0	96.9	100.0	0.0	97.2	98.3			
Heavy trucks	0	0	0	0	0	0	0	0	0	0	0	1	1	0	0	2	0	2	0	0	2	4			
%Heavy trucks	0.0	0.0	0.0	0.0	0.0	0.0	0.0	0.0	0.0	0.0	0.0	8.3	0.8	0.0	0.0	1.4	0.0	3.1	0.0	0.0	2.8	1.7			

Project ID: 21-180077-004
 Location: Rays Rd & Memorial Dr/SR 10
 City: Stone Mountain

Day: Thursday
 Date: 3/25/2021

Groups Printed - Cars, PU, Vans - Heavy Trucks

Start Time	Rays Rd Northbound						Rays Rd Southbound						Memorial Dr/SR 10 Eastbound						Memorial Dr/SR 10 Westbound						Int. Total
	Left	Thru	Rgt	Utum	Peds	App. Total	Left	Thru	Rgt	Utum	Peds	App. Total	Left	Thru	Rgt	Utum	Peds	App. Total	Left	Thru	Rgt	Utum	Peds	App. Total	
7:00 AM	2	8	2	0	0	12	3	3	39	1	0	46	14	96	3	0	0	113	2	199	13	0	0	214	385
7:15 AM	3	12	2	0	0	17	6	6	41	0	0	53	21	96	3	0	0	120	0	204	20	0	0	224	414
7:30 AM	4	14	4	0	0	22	16	14	38	0	1	68	18	116	2	2	0	138	1	191	12	1	0	205	433
7:45 AM	9	15	2	0	1	26	10	6	35	0	0	51	21	148	9	0	0	178	0	229	11	0	0	240	495
Total	18	49	10	0	1	77	35	29	153	1	1	218	74	456	17	2	0	549	3	823	56	1	0	883	1727
8:00 AM	12	13	3	0	0	28	14	11	53	0	1	78	19	131	8	2	0	160	5	215	13	1	0	234	500
8:15 AM	8	17	4	0	0	29	15	7	41	0	1	63	17	132	8	3	0	160	1	200	15	3	0	219	471
8:30 AM	7	23	4	0	1	34	8	12	51	0	0	71	17	112	5	1	0	135	4	203	19	6	0	232	472
8:45 AM	17	19	3	0	0	39	13	12	56	0	0	81	27	122	4	0	1	153	2	183	15	3	0	203	476
Total	44	72	14	0	1	130	50	42	201	0	2	293	80	497	25	6	1	608	12	801	62	13	0	888	1919
BREAK																									
4:00 PM	18	17	13	0	0	48	50	43	76	0	0	169	59	269	21	1	0	350	5	254	28	8	0	295	862
4:15 PM	20	14	6	0	1	40	40	28	71	0	0	139	55	275	14	4	0	348	10	248	36	6	0	300	827
4:30 PM	13	18	6	0	2	37	39	48	68	0	0	155	46	297	16	4	0	363	12	276	21	10	1	319	874
4:45 PM	7	17	10	0	0	34	48	41	66	0	1	155	33	253	17	4	0	307	8	243	26	5	1	282	778
Total	58	66	35	0	3	159	177	160	281	0	1	618	193	1094	68	13	0	1368	35	1021	111	29	2	1196	3341
5:00 PM	15	20	6	0	0	41	30	31	65	0	1	126	42	304	14	2	0	362	6	280	29	3	0	318	847
5:15 PM	14	17	12	0	1	43	41	48	74	0	0	163	43	327	18	3	0	391	9	266	32	3	0	310	907
5:30 PM	16	26	11	0	1	53	51	45	88	0	0	184	48	327	10	3	0	388	12	259	30	3	0	304	929
5:45 PM	11	13	9	0	2	33	38	43	58	0	0	139	44	296	25	1	0	366	9	253	30	4	1	296	834
Total	56	76	38	0	4	170	160	167	285	0	1	612	177	1254	67	9	0	1507	36	1058	121	13	1	1228	3517
Grand Total	176	263	97	0	9	536	422	398	920	1	5	1741	524	3301	177	30	1	4032	86	3703	350	56	3	4195	10504
Apprch %	32.8	49.1	18.1	0.0	1.7		24.2	22.9	52.8	0.1	0.3		13.0	81.9	4.4	0.7	0.0		2.1	88.3	8.3	1.3	0.1		
Total %	1.7	2.5	0.9	0.0	0.1	5.1	4.0	3.8	8.8	0.0	0.0	16.6	5.0	31.4	1.7	0.3	0.0	38.4	0.8	35.3	3.3	0.5	0.0	39.9	
Cars, PU, Vans	172	261	97	0	5	530	404	395	897	1	1697	499	3186	170	30	3885	85	3567	336	55	4043			10155	
% Cars, PU, Vans	97.7	99.2	100.0	0.0	98.9	98.9	95.7	99.2	97.5	100.0	97.5	95.2	96.5	96.0	100.0	96.4	98.8	96.3	96.0	98.2	96.4			96.7	
Heavy trucks	4	2	0	0	6	6	18	3	23	0	44	25	115	7	0	147	1	136	14	1	152			349	
% Heavy trucks	2.3	0.8	0.0	0.0	1.1	1.1	4.3	0.8	2.5	0.0	2.5	4.8	3.5	4.0	0.0	3.6	1.2	3.7	4.0	1.8	3.6			3.3	

Project ID: 21-180077-004
 Location: Rays Rd & Memorial Dr/SR 10
 City: Stone Mountain

PEAK HOURS

Day: Thursday
 Date: 3/25/2021

AM

Start Time	Rays Rd Northbound						Rays Rd Southbound						Memorial Dr/SR 10 Eastbound						Memorial Dr/SR 10 Westbound						Int. Total	
	Left	Thru	Rgt	Utum	Peds	App. Total	Left	Thru	Rgt	Utum	Peds	App. Total	Left	Thru	Rgt	Utum	Peds	App. Total	Left	Thru	Rgt	Utum	Peds	App. Total		
Peak Hour Analysis from 07:00 AM - 09:00 AM																										
Peak Hour for Entire Intersection Begins at 07:45 AM																										
7:45 AM	9	15	2	0	0	26	10	6	35	0	51	21	148	9	0	178	0	229	11	0	240			495		
8:00 AM	12	13	3	0	0	28	14	11	53	0	78	19	131	8	2	160	5	215	13	1	234			500		
8:15 AM	8	17	4	0	0	29	15	7	41	0	63	17	132	8	3	160	1	200	15	3	219			471		
8:30 AM	7	23	4	0	0	34	8	12	51	0	71	17	112	5	1	135	4	203	19	6	232			472		
Total Volume	36	68	13	0	0	117	47	36	180	0	263	74	523	30	6	633	10	847	58	10	925			1938		
% App. Total	30.8	58.1	11.1	0.0	0.0	100	17.9	13.7	68.4	0.0	100	11.7	82.6	4.7	0.9	100	1.1	91.6	6.3	1.1	100			100		
PHF	0.860						0.843						0.889						0.964						0.969	
Cars, PU, Vans	36	67	13	0	0	116	42	36	167	0	245	67	488	29	6	590	9	805	54	10	878			1829		
% Cars, PU, Vans	100.0	98.5	100.0	0.0	0.0	99.1	89.4	100.0	92.8	0.0	93.2	90.5	93.3	96.7	100.0	93.2	90.0	95.0	93.1	100.0	94.9			94.4		
Heavy trucks	0	1	0	0	0	1	5	0	13	0	18	7	35	1	0	43	1	42	4	0	47			109		
% Heavy trucks	0.0	1.5	0.0	0.0	0.0	0.9	10.6	0.0	7.2	0.0	6.8	9.5	6.7	3.3	0.0	6.8	10.0	5.0	6.9	0.0	5.1			5.6		

PM

Start Time	Rays Rd Northbound						Rays Rd Southbound						Memorial Dr/SR 10 Eastbound						Memorial Dr/SR 10 Westbound						Int. Total	
	Left	Thru	Rgt	Utum	Peds	App. Total	Left	Thru	Rgt	Utum	Peds	App. Total	Left	Thru	Rgt	Utum	Peds	App. Total	Left	Thru	Rgt	Utum	Peds	App. Total		
Peak Hour Analysis from 04:00 PM - 06:00 PM																										
Peak Hour for Entire Intersection Begins at 05:00 PM																										
5:00 PM	15	20	6	0	0	41	30	31	65	0	126	42	304	14	2	362	6	280	29	3	318			847		
5:15 PM	14	17	12	0	0	43	41	48	74	0	163	43	327	18	3	391	9	266	32	3	310			907		
5:30 PM	16	26	11	0	0	53	51	45	88	0	184	48	327	10	3	388	12	259	30	3	304			929		
5:45 PM	11	13	9	0	0	33	38	43	58	0	139	44	296	25	1	366	9	253	30	4	296			834		
Total Volume	56	76	38	0	0	170	160	167	285	0	612	177	1254	67	9	1507	36	1058	121	13	1228			3517		
% App. Total	32.9	44.7	22.4	0.0	0.0	100	26.1	27.3	46.6	0.0	100	11.7	83.2	4.4	0.6	100	2.9	86.2	9.9	1.1	100			100		
PHF	0.802						0.832						0.832						0.964						0.965	
Cars, PU, Vans	55	76	38	0	0	169	157	166	282	0	605	173	1227	66	9	1475	36	1040	120	13	1209			3458		
% Cars, PU, Vans	98.2	100.0	100.0	0.0	0.0	99.4	89.1	99.4	98.9	0.0	98.9	97.7	97.6	98.5	100.0	97.9	100.0	98.3	99.2	100.0	98.5			98.3		
Heavy trucks	1	0	0	0	0	1	3	1	3	0	7	4	27	1	0	32	0	18	1	0	19			59		
% Heavy trucks	1.8	0.0	0.0	0.0	0.0	0.6	1.9	0.6	1.1	0.0	1.1	2.3	2.2	1.5	0.0	2.1	0.0	1.7	0.8	0.0	1.5			1.7		

VOLUME

Norman Rd Bet. Otello Ave & Viking Dr

Day: Thursday
Date: 3/25/2021

City: Stone Mountain
Project #: GA21_180078_001

DAILY TOTALS					NB	SB						Total	
					0	0						2,446	
							1,365					1,081	
AM Period	NB	SB	EB	WB	TOTAL	PM Period	NB	SB	EB	WB	TOTAL		
00:00			4	3	7	12:00			16	14	30		
00:15			4	2	6	12:15			17	19	36		
00:30			4	4	8	12:30			18	12	30		
00:45			5	17	22	12:45			22	73	95		
01:00			6	2	8	13:00			22	16	38		
01:15			2	5	7	13:15			23	15	38		
01:30			3	3	6	13:30			22	22	44		
01:45			4	15	19	13:45			21	88	109		
02:00			4	2	6	14:00			23	29	52		
02:15			1	2	3	14:15			22	22	44		
02:30			1	4	5	14:30			26	14	40		
02:45			4	10	14	14:45			32	103	135		
03:00			1	0	1	15:00			40	14	54		
03:15			2	0	2	15:15			47	20	67		
03:30			1	0	1	15:30			42	20	62		
03:45			1	5	6	15:45			27	156	183		
04:00			0	1	1	16:00			26	15	41		
04:15			0	1	1	16:15			29	20	49		
04:30			3	1	4	16:30			33	15	48		
04:45			1	4	5	16:45			29	117	146		
05:00			2	1	3	17:00			32	17	49		
05:15			1	3	4	17:15			31	26	57		
05:30			6	2	8	17:30			41	16	57		
05:45			4	13	17	17:45			39	143	182		
06:00			4	4	8	18:00			29	17	46		
06:15			9	11	20	18:15			31	17	48		
06:30			4	21	25	18:30			38	15	53		
06:45			5	22	27	18:45			21	119	140		
07:00			7	21	28	19:00			22	11	33		
07:15			20	18	38	19:15			24	14	38		
07:30			18	21	39	19:30			20	7	27		
07:45			14	59	73	19:45			19	85	104		
08:00			11	20	31	20:00			12	18	30		
08:15			12	16	28	20:15			10	12	22		
08:30			10	19	29	20:30			15	11	26		
08:45			13	46	59	20:45			10	47	57		
09:00			14	15	29	21:00			8	4	12		
09:15			9	15	24	21:15			9	8	17		
09:30			13	10	23	21:30			15	14	29		
09:45			8	44	52	21:45			6	38	44		
10:00			9	8	17	22:00			11	6	17		
10:15			10	11	21	22:15			9	5	14		
10:30			14	13	27	22:30			9	10	19		
10:45			19	52	71	22:45			4	33	37		
11:00			17	25	42	23:00			2	1	3		
11:15			12	7	19	23:15			3	1	4		
11:30			16	15	31	23:30			8	3	11		
11:45			13	58	71	23:45			5	18	23		
TOTALS				345	420	765	TOTALS		1020	661	1681		
SPLIT %				45.1%	54.9%	31.3%	SPLIT %		60.7%	39.3%	68.7%		

DAILY TOTALS					NB	SB						Total	
					0	0						2,446	
							1,365					1,081	
AM Peak Hour			10:45	06:30	06:45	PM Peak Hour			14:45	13:30	15:00		
AM Pk Volume			64	89	139	PM Pk Volume			161	90	237		
Pk Hr Factor			0.842	0.767	0.891	Pk Hr Factor			0.856	0.776	0.884		
7 - 9 Volume	0	0	105	143	248	4 - 6 Volume	0	0	260	142	402		
7 - 9 Peak Hour			07:15	08:00	07:15	4 - 6 Peak Hour			17:00	17:00	17:00		
7 - 9 Pk Volume	0	0	63	73	132	4 - 6 Pk Volume	0	0	143	80	223		
Pk Hr Factor	0.000	0.000	0.788	0.913	0.846	Pk Hr Factor	0.000	0.000	0.872	0.769	0.929		

Growth Rate Calculations

Percentage Growth											
Roadway	County	Traffic Count Station	2016 Traffic Volumes	2017 Traffic Volumes	2018 Traffic Volumes	2019 Traffic Volumes	2020 Traffic Volumes by Linear Regress.	2021 Traffic Volumes by Linear Regress.	2024 Traffic Volumes by Linear Regress.	Annual Growth 2020 to 2022	Annual Growth 2020 to 2025
Rays Rd	DeKalb	089-3995	9,860	10,100	10,500	10,700	11,020	11,312	12,188	2.6%	2.6%
Memorial Dr	DeKalb	089-3049	33,200	35,100	35,000	40,800	41,700	43,970	50,780	5.4%	5.2%
E Ponce de Leon Ave	DeKalb	089-3743	18,700	19,800	18,800	19,000	19,050	19,040	19,010	-0.1%	-0.1%
Weighted Average			61,760	65,000	64,300	70,500	71,770	74,322	81,978	3.6%	3.4%

Adjustment Factor Calculations

2019

	Eastbound	Westbound	Northbound	Southbound	Total
8:00 AM	971	1014	117	196	2298
6:00 PM	1560	721	143	350	2774

2021

	Eastbound	Westbound	Northbound	Southbound	Total
8:00 AM	576	807	87	171	1641
6:00 PM	1050	1311	122	303	2786

	Eastbound	Westbound	Northbound	Southbound	Total
	2019/2021	2019/2021	2019/2021	2019/2021	AVG
8:00 AM	1.69	1.26	1.40	1.15	1.37
6:00 PM	1.49	0.55	1.00	1.16	1.05

AM	1.40
PM	1.05

Signal

(<http://www.dot.ga.gov>)

Signal Selection

Signal ID

7740

Select

SR 10 @ Rays Road

Signal List

Signal Map

Region

--Select Region--



Metric Type

--Select a Metric--

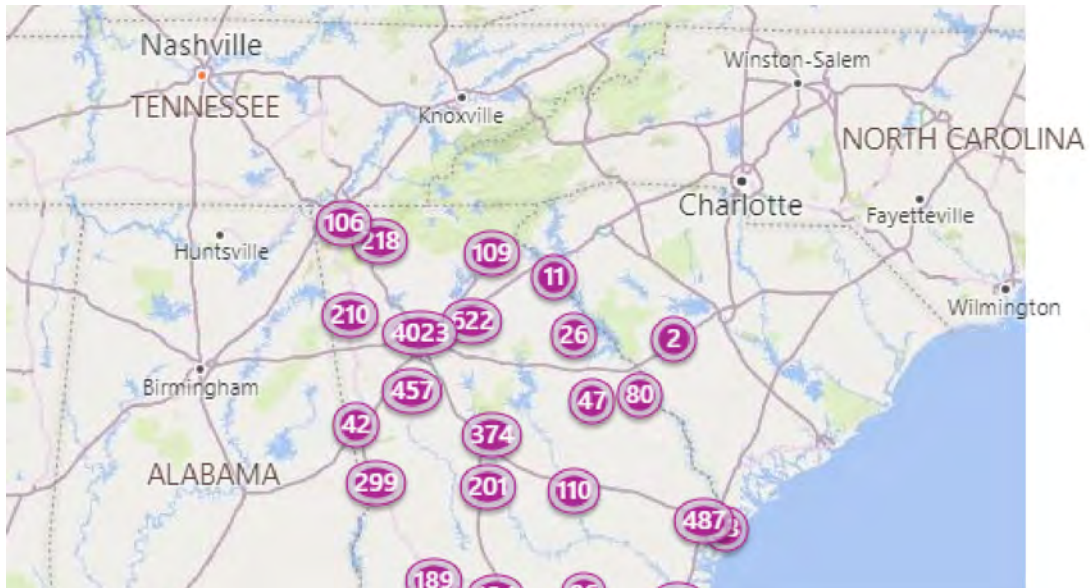



Chart Selection

Metrics List

- Purdue Phase Termination
- Split Monitor
- Pedestrian Delay
- Preemption Details
- Turning Movement Counts
- Purdue Coordination Diagram
- Approach Volume
- Approach Delay
- Arrivals On Red
- Purdue Split Failure
- Left Turn Gap Analysis

Turning Movement Counts Options

Thru Movement Y-axis Max

1000

Turn Movement Y- axis Max

300

Volume Bin Size

60

- Show MovementType Volume
- Show Total Volume
- Show Data Table

Date Selection

Start Date

03/20/2019 12:00 AM

March 2019

Su Mo Tu We Th Fr Sa

End Date

03/20/2019	11:59	PM	▼
------------	-------	----	---

Reset Date

Su	Mo	Tu	We	Th	Fr	Sa
					1	2
3	4	5	6	7	8	9
10	11	12	13	14	15	16
17	18	19	20	21	22	23
24	25	26	27	28	29	30
31						

Create Chart

	Vehicle														Vehicle Total
	Eastbound			Westbound			Northbound				Southbound				
	L	T	Total	L	T	Total	L	T	TR	Total	L	T	R	Total	
12:00 AM	35	292	327	3	116	119	4	7	4	15	23	20	34	77	538
1:00 AM	29	132	161	0	53	53	5	6	2	13	14	15	20	49	276
2:00 AM	23	111	134	3	53	56	6	7	3	16	9	8	17	34	240
3:00 AM	12	94	106	1	49	50	3	2	0	5	5	6	29	40	201
4:00 AM	8	92	100	3	78	81	5	12	5	22	10	10	37	57	260
5:00 AM	22	186	208	4	227	231	12	20	5	37	9	9	65	83	559
6:00 AM	52	434	486	6	710	716	27	32	16	75	17	27	91	135	1412
7:00 AM	53	839	892	10	1336	1346	55	80	32	167	25	45	160	230	2635
8:00 AM	37	934	971	23	991	1014	50	43	24	117	29	47	120	196	2298
9:00 AM	27	793	820	16	622	638	36	28	27	91	29	36	130	195	1744
10:00 AM	60	792	852	23	506	529	37	34	24	95	32	34	119	185	1661
11:00 AM	44	877	921	29	534	563	38	29	20	87	35	44	126	205	1776
12:00 PM	54	1061	1115	25	547	572	43	44	30	117	41	62	128	231	2035
1:00 PM	69	1164	1233	20	613	633	53	38	42	133	46	67	122	235	2234
2:00 PM	55	1304	1359	31	697	728	60	49	37	146	38	73	144	255	2488
3:00 PM	46	1341	1387	27	639	666	56	34	29	119	39	98	156	293	2107
4:00 PM	46	1601	1647	26	738	764	57	54	39	150	35	133	157	325	2107

5:00 PM	46	1595	1641	25	721	746	51	48	36	135	45	144	176	365	2887
6:00 PM	43	1517	1560	29	692	721	67	43	33	143	36	124	190	350	2774
7:00 PM	34	979	1013	22	481	503	40	34	30	104	34	83	127	244	1864
8:00 PM	42	868	910	32	421	453	36	35	20	91	33	63	104	200	1654
9:00 PM	44	699	743	23	291	314	32	24	15	71	34	37	78	149	1277
10:00 PM	46	511	557	12	256	268	11	12	19	42	23	28	68	119	986
11:00 PM	37	410	447	16	171	187	11	17	13	41	25	26	67	118	793
Total	964	18626	19590	409	11542	11951	795	732	505	2032	666	1239	2465	4370	37943

Signal

(<http://www.dot.ga.gov>)

Signal Selection

Signal ID

7740

Select

SR 10 @ Rays Road

Signal List

Signal Map

Region

--Select Region--



Metric Type

Turning Movement Counts

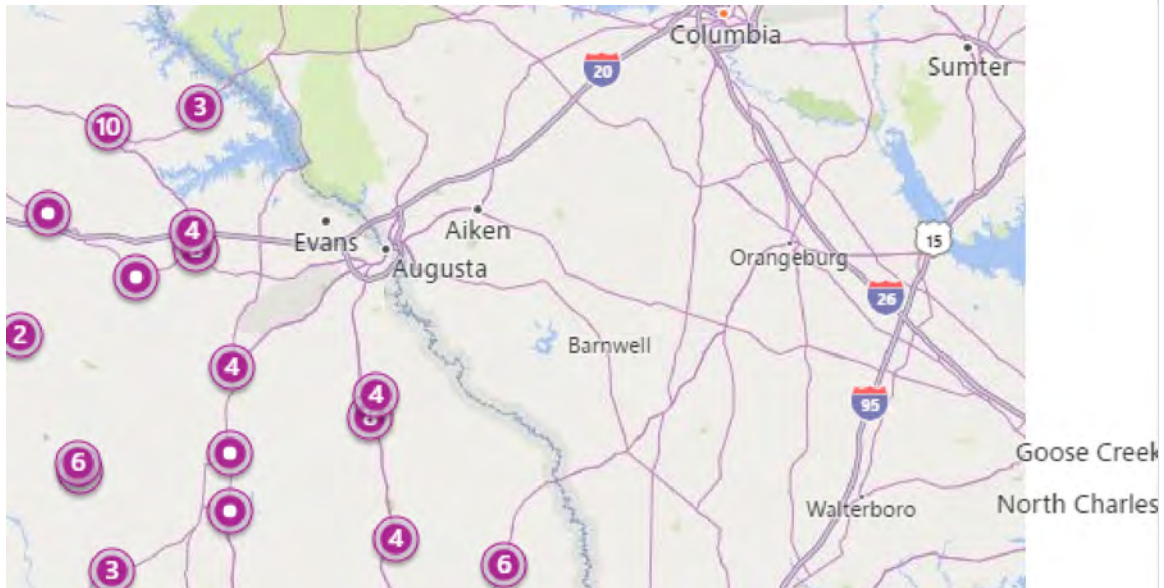



Chart Selection

Metrics List

- Purdue Phase Termination
- Split Monitor
- Pedestrian Delay
- Preemption Details
- Turning Movement Counts
- Purdue Coordination Diagram
- Approach Volume
- Approach Delay
- Arrivals On Red
- Purdue Split Failure
- Left Turn Gap Analysis

Turning Movement Counts Options

Thru Movement Y-axis Max

1000

Turn Movement Y- axis Max

300

Volume Bin Size

60

- Show MovementType Volume
- Show Total Volume
- Show Data Table

Date Selection

Start Date

03/24/2021 12:00 AM

◀ April 2021 ▶

Su Mo Tu We Th Fr Sa

End Date

03/24/2021	11:59	PM	▼
------------	-------	----	---

Reset Date

Su Mo Tu We Th Fr Sa

				1	2	3
4	5	6	7	8	9	10
11	12	13	14	15	16	17
18	19	20	21	22	23	24
25	26	27	28	29	30	

Create Chart

	Vehicle														Vehicle Total
	Eastbound			Westbound			Northbound				Southbound				
	L	T	Total	L	T	Total	L	T	TR	Total	L	T	R	Total	
12:00 AM	36	272	308	5	236	241	10	6	8	24	22	18	25	65	638
1:00 AM	31	234	265	4	127	131	7	9	2	18	15	16	22	53	467
2:00 AM	18	182	200	1	102	103	7	4	2	13	11	8	14	33	349
3:00 AM	22	124	146	2	125	127	4	3	5	12	6	10	19	35	320
4:00 AM	18	126	144	4	104	108	9	8	4	21	11	6	32	49	322
5:00 AM	17	281	298	4	269	273	7	18	5	30	9	7	58	74	675
6:00 AM	22	201	223	3	425	428	11	19	10	40	20	16	63	99	790
7:00 AM	13	220	233	5	521	526	15	18	9	42	10	14	60	84	885
8:00 AM	30	546	576	15	807	822	32	33	22	87	30	31	111	172	1657
9:00 AM	37	571	608	18	824	842	34	40	26	100	27	58	86	171	1721
10:00 AM	31	581	612	10	821	831	26	31	21	78	30	41	103	174	1695
11:00 AM	38	738	776	16	1009	1025	33	38	28	99	41	52	125	218	2118
12:00 PM	48	784	832	26	1396	1422	50	45	35	130	42	59	136	237	2621
1:00 PM	48	838	886	25	1436	1461	48	53	32	133	48	70	136	254	2734
2:00 PM	52	889	941	28	1533	1561	59	52	39	150	51	80	142	273	2925
3:00 PM	46	977	1023	26	1635	1661	51	43	43	137	46	103	139	288	3109
4:00 PM	53	973	1026	29	1833	1862	50	41	30	121	44	97	121	262	
5:00 PM	52	1136	1188	26	1599	1625	52	47	44	143	45	112	155	312	

6:00 PM	54	996	1050	17	1294	1311	47	44	31	122	44	121	138	303	2786
7:00 PM	48	837	885	29	940	969	53	31	30	114	46	49	107	202	2170
8:00 PM	54	697	751	16	816	832	44	43	30	117	43	64	56	163	1863
9:00 PM	46	563	609	17	643	660	20	22	22	64	35	44	87	166	1499
10:00 PM	44	419	463	13	428	441	15	17	19	51	29	32	61	122	1077
11:00 PM	42	330	372	16	280	296	12	20	8	40	28	31	42	101	809
Total	900	13515	14415	355	19203	19558	696	685	505	1886	733	1139	2038	3910	39769

APPENDIX C: SYNCHRO REPORTS

Intersection												
Int Delay, s/veh	4.4											
Movement	EBL	EBT	EBR	WBL	WBT	WBR	NBL	NBT	NBR	SBL	SBT	SBR
Lane Configurations		↕			↕			↕			↕	
Traffic Vol, veh/h	19	35	0	0	51	17	0	0	1	22	0	52
Future Vol, veh/h	19	35	0	0	51	17	0	0	1	22	0	52
Conflicting Peds, #/hr	0	0	0	0	0	0	0	0	0	0	0	0
Sign Control	Free	Free	Free	Free	Free	Free	Stop	Stop	Stop	Stop	Stop	Stop
RT Channelized	-	-	None	-	-	None	-	-	None	-	-	None
Storage Length	-	-	-	-	-	-	-	-	-	-	-	-
Veh in Median Storage, #	-	0	-	-	0	-	-	0	-	-	0	-
Grade, %	-	0	-	-	0	-	-	0	-	-	0	-
Peak Hour Factor	79	79	79	79	79	79	79	79	79	79	79	79
Heavy Vehicles, %	2	9	2	2	12	6	2	2	2	23	2	14
Mvmt Flow	24	44	0	0	65	22	0	0	1	28	0	66

Major/Minor	Major1		Major2		Minor1		Minor2					
Conflicting Flow All	87	0	0	44	0	0	201	179	44	169	168	76
Stage 1	-	-	-	-	-	-	92	92	-	76	76	-
Stage 2	-	-	-	-	-	-	109	87	-	93	92	-
Critical Hdwy	4.12	-	-	4.12	-	-	7.12	6.52	6.22	7.33	6.52	6.34
Critical Hdwy Stg 1	-	-	-	-	-	-	6.12	5.52	-	6.33	5.52	-
Critical Hdwy Stg 2	-	-	-	-	-	-	6.12	5.52	-	6.33	5.52	-
Follow-up Hdwy	2.218	-	-	2.218	-	-	3.518	4.018	3.318	3.707	4.018	3.426
Pot Cap-1 Maneuver	1509	-	-	1564	-	-	757	715	1026	750	725	953
Stage 1	-	-	-	-	-	-	915	819	-	883	832	-
Stage 2	-	-	-	-	-	-	896	823	-	865	819	-
Platoon blocked, %	-	-	-	-	-	-	-	-	-	-	-	-
Mov Cap-1 Maneuver	1509	-	-	1564	-	-	696	704	1026	740	713	953
Mov Cap-2 Maneuver	-	-	-	-	-	-	696	704	-	740	713	-
Stage 1	-	-	-	-	-	-	900	806	-	869	832	-
Stage 2	-	-	-	-	-	-	834	823	-	850	806	-

Approach	EB	WB	NB	SB
HCM Control Delay, s	2.6	0	8.5	9.6
HCM LOS			A	A

Minor Lane/Major Mvmt	NBLn1	EBL	EBT	EBR	WBL	WBT	WBR	SBLn1
Capacity (veh/h)	1026	1509	-	-	1564	-	-	878
HCM Lane V/C Ratio	0.001	0.016	-	-	-	-	-	0.107
HCM Control Delay (s)	8.5	7.4	0	-	0	-	-	9.6
HCM Lane LOS	A	A	A	-	A	-	-	A
HCM 95th %tile Q(veh)	0	0	-	-	0	-	-	0.4

Intersection						
Int Delay, s/veh	0					
Movement	EBT	EBR	WBL	WBT	NBL	NBR
Lane Configurations						
Traffic Vol, veh/h	59	0	0	70	0	0
Future Vol, veh/h	59	0	0	70	0	0
Conflicting Peds, #/hr	0	0	0	0	0	0
Sign Control	Free	Free	Free	Free	Stop	Stop
RT Channelized	-	None	-	None	-	None
Storage Length	-	-	-	-	0	-
Veh in Median Storage, #	0	-	-	0	0	-
Grade, %	0	-	-	0	0	-
Peak Hour Factor	92	92	92	92	92	92
Heavy Vehicles, %	2	2	2	2	2	2
Mvmt Flow	64	0	0	76	0	0

Major/Minor	Major1	Major2	Minor1		
Conflicting Flow All	0	0	64	0	140
Stage 1	-	-	-	-	64
Stage 2	-	-	-	-	76
Critical Hdwy	-	-	4.12	-	6.42
Critical Hdwy Stg 1	-	-	-	-	5.42
Critical Hdwy Stg 2	-	-	-	-	5.42
Follow-up Hdwy	-	-	2.218	-	3.518
Pot Cap-1 Maneuver	-	-	1538	-	853
Stage 1	-	-	-	-	959
Stage 2	-	-	-	-	947
Platoon blocked, %	-	-	-	-	-
Mov Cap-1 Maneuver	-	-	1538	-	853
Mov Cap-2 Maneuver	-	-	-	-	853
Stage 1	-	-	-	-	959
Stage 2	-	-	-	-	947

Approach	EB	WB	NB
HCM Control Delay, s	0	0	0
HCM LOS			A

Minor Lane/Major Mvmt	NBLn1	EBT	EBR	WBL	WBT
Capacity (veh/h)	-	-	-	1538	-
HCM Lane V/C Ratio	-	-	-	-	-
HCM Control Delay (s)	0	-	-	0	-
HCM Lane LOS	A	-	-	A	-
HCM 95th %tile Q(veh)	-	-	-	0	-

Intersection						
Int Delay, s/veh	1.7					
Movement	EBL	EBR	NBL	NBT	SBT	SBR
Lane Configurations	T			T		T
Traffic Vol, veh/h	11	33	48	161	243	20
Future Vol, veh/h	11	33	48	161	243	20
Conflicting Peds, #/hr	0	0	0	0	0	0
Sign Control	Stop	Stop	Free	Free	Free	Free
RT Channelized	-	None	-	None	-	None
Storage Length	0	-	-	-	-	-
Veh in Median Storage, #	0	-	-	0	0	-
Grade, %	0	-	-	0	0	-
Peak Hour Factor	88	88	88	88	88	88
Heavy Vehicles, %	2	3	2	6	8	2
Mvmt Flow	13	38	55	183	276	23

Major/Minor	Minor2	Major1		Major2	
Conflicting Flow All	581	288	299	0	0
Stage 1	288	-	-	-	-
Stage 2	293	-	-	-	-
Critical Hdwy	6.42	6.23	4.12	-	-
Critical Hdwy Stg 1	5.42	-	-	-	-
Critical Hdwy Stg 2	5.42	-	-	-	-
Follow-up Hdwy	3.518	3.327	2.218	-	-
Pot Cap-1 Maneuver	476	749	1262	-	-
Stage 1	761	-	-	-	-
Stage 2	757	-	-	-	-
Platoon blocked, %				-	-
Mov Cap-1 Maneuver	453	749	1262	-	-
Mov Cap-2 Maneuver	453	-	-	-	-
Stage 1	724	-	-	-	-
Stage 2	757	-	-	-	-

Approach	EB	NB	SB
HCM Control Delay, s	11.1	1.8	0
HCM LOS	B		

Minor Lane/Major Mvmt	NBL	NBT	EBLn1	SBT	SBR
Capacity (veh/h)	1262	-	644	-	-
HCM Lane V/C Ratio	0.043	-	0.078	-	-
HCM Control Delay (s)	8	0	11.1	-	-
HCM Lane LOS	A	A	B	-	-
HCM 95th %tile Q(veh)	0.1	-	0.3	-	-

Intersection						
Int Delay, s/veh	0.1					
Movement	EBL	EBR	NBL	NBT	SBT	SBR
Lane Configurations	T			T		T
Traffic Vol, veh/h	2	3	1	195	285	1
Future Vol, veh/h	2	3	1	195	285	1
Conflicting Peds, #/hr	0	0	0	0	0	0
Sign Control	Stop	Stop	Free	Free	Free	Free
RT Channelized	-	None	-	None	-	None
Storage Length	0	-	-	-	-	-
Veh in Median Storage, #	0	-	-	0	0	-
Grade, %	0	-	-	0	0	-
Peak Hour Factor	90	90	90	90	90	90
Heavy Vehicles, %	2	2	2	6	7	2
Mvmt Flow	2	3	1	217	317	1





















Major/Minor	Minor2	Major1	Major2			
Conflicting Flow All	537	318	318	0	-	0
Stage 1	318	-	-	-	-	-
Stage 2	219	-	-	-	-	-
Critical Hdwy	6.42	6.22	4.12	-	-	-
Critical Hdwy Stg 1	5.42	-	-	-	-	-
Critical Hdwy Stg 2	5.42	-	-	-	-	-
Follow-up Hdwy	3.518	3.318	2.218	-	-	-
Pot Cap-1 Maneuver	505	723	1242	-	-	-
Stage 1	738	-	-	-	-	-
Stage 2	817	-	-	-	-	-
Platoon blocked, %				-	-	-
Mov Cap-1 Maneuver	504	723	1242	-	-	-
Mov Cap-2 Maneuver	504	-	-	-	-	-
Stage 1	737	-	-	-	-	-
Stage 2	817	-	-	-	-	-

Approach	EB	NB	SB
HCM Control Delay, s	10.9	0	0
HCM LOS	B		

Minor Lane/Major Mvmt	NBL	NBT	EBLn1	SBT	SBR
Capacity (veh/h)	1242	-	616	-	-
HCM Lane V/C Ratio	0.001	-	0.009	-	-
HCM Control Delay (s)	7.9	0	10.9	-	-
HCM Lane LOS	A	A	B	-	-
HCM 95th %tile Q(veh)	0	-	0	-	-

HCM 6th Signalized Intersection Summary
5: Rays Rd & Memorial Dr

Spivey Lake Residential
Existing AM

												
Movement	EBU	EBL	EBT	EBR	WBU	WBL	WBT	WBR	NBL	NBT	NBR	SBL
Lane Configurations												
Traffic Volume (veh/h)	6	74	523	30	10	10	847	58	36	68	13	47
Future Volume (veh/h)	6	74	523	30	10	10	847	58	36	68	13	47
Initial Q (Qb), veh		0	0	0		0	0	0	0	0	0	0
Ped-Bike Adj(A_pbT)		1.00		1.00		1.00		1.00	1.00		1.00	1.00
Parking Bus, Adj		1.00	1.00	1.00		1.00	1.00	1.00	1.00	1.00	1.00	1.00
Work Zone On Approach			No				No			No		
Adj Sat Flow, veh/h/ln		1752	1796	1856		1752	1826	1796	1870	1870	1870	1737
Adj Flow Rate, veh/h		76	539	0		10	873	0	37	70	13	48
Peak Hour Factor		0.97	0.97	0.97		0.97	0.97	0.97	0.97	0.97	0.97	0.97
Percent Heavy Veh, %		10	7	3		10	5	7	2	2	2	11
Cap, veh/h		163	1455			40	1290		561	1069	193	130
Arrive On Green		0.05	0.30	0.00		0.01	0.26	0.00	0.03	0.36	0.36	0.04
Sat Flow, veh/h		3237	4904	1572		3237	4985	1522	1781	3006	544	3209
Grp Volume(v), veh/h		76	539	0		10	873	0	37	41	42	48
Grp Sat Flow(s),veh/h/ln		1618	1635	1572		1618	1662	1522	1781	1777	1772	1605
Q Serve(g_s), s		1.9	7.1	0.0		0.2	12.8	0.0	1.1	1.2	1.3	1.2
Cycle Q Clear(g_c), s		1.9	7.1	0.0		0.2	12.8	0.0	1.1	1.2	1.3	1.2
Prop In Lane		1.00		1.00		1.00		1.00	1.00		0.31	1.00
Lane Grp Cap(c), veh/h		163	1455			40	1290		561	632	631	130
V/C Ratio(X)		0.47	0.37			0.25	0.68		0.07	0.06	0.07	0.37
Avail Cap(c_a), veh/h		477	2948			357	2813		696	632	631	354
HCM Platoon Ratio		1.00	1.00	1.00		1.00	1.00	1.00	1.00	1.00	1.00	1.00
Upstream Filter(l)		1.00	1.00	0.00		1.00	1.00	0.00	1.00	1.00	1.00	1.00
Uniform Delay (d), s/veh		37.6	22.6	0.0		39.9	27.1	0.0	15.5	17.3	17.3	38.1
Incr Delay (d2), s/veh		2.1	0.2	0.0		3.2	0.6	0.0	0.0	0.2	0.2	1.7
Initial Q Delay(d3),s/veh		0.0	0.0	0.0		0.0	0.0	0.0	0.0	0.0	0.0	0.0
%ile BackOfQ(50%),veh/ln		0.7	2.5	0.0		0.1	4.7	0.0	0.4	0.5	0.5	0.5
Unsig. Movement Delay, s/veh												
LnGrp Delay(d),s/veh		39.7	22.8	0.0		43.0	27.8	0.0	15.5	17.5	17.5	39.8
LnGrp LOS		D	C			D	C		B	B	B	D
Approach Vol, veh/h			615	A			883	A		120		
Approach Delay, s/veh			24.9				27.9			16.9		
Approach LOS			C				C			B		
Timer - Assigned Phs	1	2	3	4	5	6	7	8				
Phs Duration (G+Y+Rc), s	10.1	27.1	8.8	35.5	7.0	30.2	9.3	35.0				
Change Period (Y+Rc), s	6.0	6.0	6.0	6.0	6.0	6.0	6.0	6.0				
Max Green Setting (Gmax), s	12.0	46.0	9.0	29.0	9.0	49.0	9.0	29.0				
Max Q Clear Time (g_c+I1), s	3.9	14.8	3.1	9.2	2.2	9.1	3.2	3.3				
Green Ext Time (p_c), s	0.1	6.3	0.0	0.7	0.0	3.7	0.0	0.4				
Intersection Summary												
HCM 6th Ctrl Delay			25.6									
HCM 6th LOS			C									
Notes												
User approved ignoring U-Turning movement.												
Unsignalized Delay for [EBR, WBR] is excluded from calculations of the approach delay and intersection delay.												

HCM 6th Signalized Intersection Summary
 5: Rays Rd & Memorial Dr

Spivey Lake Residential
 Existing AM



Movement	SBT	SBR
Lane Configurations	↑↑	↑
Traffic Volume (veh/h)	36	180
Future Volume (veh/h)	36	180
Initial Q (Qb), veh	0	0
Ped-Bike Adj(A_pbT)		1.00
Parking Bus, Adj	1.00	1.00
Work Zone On Approach	No	
Adj Sat Flow, veh/h/ln	1870	1796
Adj Flow Rate, veh/h	37	186
Peak Hour Factor	0.97	0.97
Percent Heavy Veh, %	2	7
Cap, veh/h	1285	551
Arrive On Green	0.36	0.36
Sat Flow, veh/h	3554	1522
Grp Volume(v), veh/h	37	186
Grp Sat Flow(s),veh/h/ln	1777	1522
Q Serve(g_s), s	0.5	7.2
Cycle Q Clear(g_c), s	0.5	7.2
Prop In Lane		1.00
Lane Grp Cap(c), veh/h	1285	551
V/C Ratio(X)	0.03	0.34
Avail Cap(c_a), veh/h	1285	551
HCM Platoon Ratio	1.00	1.00
Upstream Filter(l)	1.00	1.00
Uniform Delay (d), s/veh	16.8	18.9
Incr Delay (d2), s/veh	0.0	1.7
Initial Q Delay(d3),s/veh	0.0	0.0
%ile BackOfQ(50%),veh/ln	0.2	0.3
Unsig. Movement Delay, s/veh		
LnGrp Delay(d),s/veh	16.8	20.6
LnGrp LOS	B	C
Approach Vol, veh/h	271	
Approach Delay, s/veh	23.5	
Approach LOS	C	
Timer - Assigned Phs		

Intersection												
Int Delay, s/veh	1.4											
Movement	EBL	EBT	EBR	WBL	WBT	WBR	NBL	NBT	NBR	SBL	SBT	SBR
Lane Configurations		↕			↕			↕			↕	
Traffic Vol, veh/h	12	127	0	0	64	8	0	1	1	11	1	11
Future Vol, veh/h	12	127	0	0	64	8	0	1	1	11	1	11
Conflicting Peds, #/hr	0	0	0	0	0	0	0	0	0	0	0	0
Sign Control	Free	Free	Free	Free	Free	Free	Stop	Stop	Stop	Stop	Stop	Stop
RT Channelized	-	-	None	-	-	None	-	-	None	-	-	None
Storage Length	-	-	-	-	-	-	-	-	-	-	-	-
Veh in Median Storage, #	-	0	-	-	0	-	-	0	-	-	0	-
Grade, %	-	0	-	-	0	-	-	0	-	-	0	-
Peak Hour Factor	91	91	91	91	91	91	91	91	91	91	91	91
Heavy Vehicles, %	8	2	2	2	3	2	2	2	2	2	2	2
Mvmt Flow	13	140	0	0	70	9	0	1	1	12	1	12

Major/Minor	Major1			Major2			Minor1			Minor2		
Conflicting Flow All	79	0	0	140	0	0	247	245	140	242	241	75
Stage 1	-	-	-	-	-	-	166	166	-	75	75	-
Stage 2	-	-	-	-	-	-	81	79	-	167	166	-
Critical Hdwy	4.18	-	-	4.12	-	-	7.12	6.52	6.22	7.12	6.52	6.22
Critical Hdwy Stg 1	-	-	-	-	-	-	6.12	5.52	-	6.12	5.52	-
Critical Hdwy Stg 2	-	-	-	-	-	-	6.12	5.52	-	6.12	5.52	-
Follow-up Hdwy	2.272	-	-	2.218	-	-	3.518	4.018	3.318	3.518	4.018	3.318
Pot Cap-1 Maneuver	1482	-	-	1443	-	-	707	657	908	712	660	986
Stage 1	-	-	-	-	-	-	836	761	-	934	833	-
Stage 2	-	-	-	-	-	-	927	829	-	835	761	-
Platoon blocked, %		-	-		-	-						
Mov Cap-1 Maneuver	1482	-	-	1443	-	-	692	650	908	705	653	986
Mov Cap-2 Maneuver	-	-	-	-	-	-	692	650	-	705	653	-
Stage 1	-	-	-	-	-	-	828	753	-	925	833	-
Stage 2	-	-	-	-	-	-	914	829	-	824	753	-

Approach	EB	WB	NB	SB
HCM Control Delay, s	0.6	0	9.8	9.6
HCM LOS			A	A

Minor Lane/Major Mvmt	NBLn1	EBL	EBT	EBR	WBL	WBT	WBR	SBLn1
Capacity (veh/h)	758	1482	-	-	1443	-	-	813
HCM Lane V/C Ratio	0.003	0.009	-	-	-	-	-	0.031
HCM Control Delay (s)	9.8	7.5	0	-	0	-	-	9.6
HCM Lane LOS	A	A	A	-	A	-	-	A
HCM 95th %tile Q(veh)	0	0	-	-	0	-	-	0.1

Intersection						
Int Delay, s/veh	0					
Movement	EBT	EBR	WBL	WBT	NBL	NBR
Lane Configurations						
Traffic Vol, veh/h	143	0	0	80	0	0
Future Vol, veh/h	143	0	0	80	0	0
Conflicting Peds, #/hr	0	0	0	0	0	0
Sign Control	Free	Free	Free	Free	Stop	Stop
RT Channelized	-	None	-	None	-	None
Storage Length	-	-	-	-	0	-
Veh in Median Storage, #	0	-	-	0	0	-
Grade, %	0	-	-	0	0	-
Peak Hour Factor	92	92	92	92	92	92
Heavy Vehicles, %	2	2	2	2	2	2
Mvmt Flow	155	0	0	87	0	0
Major/Minor	Major1	Major2	Minor1			
Conflicting Flow All	0	0	155	0	242	155
Stage 1	-	-	-	-	155	-
Stage 2	-	-	-	-	87	-
Critical Hdwy	-	-	4.12	-	6.42	6.22
Critical Hdwy Stg 1	-	-	-	-	5.42	-
Critical Hdwy Stg 2	-	-	-	-	5.42	-
Follow-up Hdwy	-	-	2.218	-	3.518	3.318
Pot Cap-1 Maneuver	-	-	1425	-	746	891
Stage 1	-	-	-	-	873	-
Stage 2	-	-	-	-	936	-
Platoon blocked, %	-	-	-	-	-	-
Mov Cap-1 Maneuver	-	-	1425	-	746	891
Mov Cap-2 Maneuver	-	-	-	-	746	-
Stage 1	-	-	-	-	873	-
Stage 2	-	-	-	-	936	-
Approach	EB	WB	NB			
HCM Control Delay, s	0	0	0			
HCM LOS					A	
Minor Lane/Major Mvmt	NBLn1	EBT	EBR	WBL	WBT	
Capacity (veh/h)	-	-	-	1425	-	
HCM Lane V/C Ratio	-	-	-	-	-	
HCM Control Delay (s)	0	-	-	0	-	
HCM Lane LOS	A	-	-	A	-	
HCM 95th %tile Q(veh)	-	-	-	0	-	

Intersection						
Int Delay, s/veh	2.9					
Movement	EBL	EBR	NBL	NBT	SBT	SBR
Lane Configurations	T			T		
Traffic Vol, veh/h	31	107	57	293	481	21
Future Vol, veh/h	31	107	57	293	481	21
Conflicting Peds, #/hr	0	0	0	0	0	0
Sign Control	Stop	Stop	Free	Free	Free	Free
RT Channelized	-	None	-	None	-	None
Storage Length	0	-	-	-	-	-
Veh in Median Storage, #	0	-	-	0	0	-
Grade, %	0	-	-	0	0	-
Peak Hour Factor	92	92	92	92	92	92
Heavy Vehicles, %	2	2	2	2	2	5
Mvmt Flow	34	116	62	318	523	23

Major/Minor	Minor2	Major1	Major2			
Conflicting Flow All	977	535	546	0	-	0
Stage 1	535	-	-	-	-	-
Stage 2	442	-	-	-	-	-
Critical Hdwy	6.42	6.22	4.12	-	-	-
Critical Hdwy Stg 1	5.42	-	-	-	-	-
Critical Hdwy Stg 2	5.42	-	-	-	-	-
Follow-up Hdwy	3.518	3.318	2.218	-	-	-
Pot Cap-1 Maneuver	278	545	1023	-	-	-
Stage 1	587	-	-	-	-	-
Stage 2	648	-	-	-	-	-
Platoon blocked, %				-	-	-
Mov Cap-1 Maneuver	257	545	1023	-	-	-
Mov Cap-2 Maneuver	257	-	-	-	-	-
Stage 1	544	-	-	-	-	-
Stage 2	648	-	-	-	-	-

Approach	EB	NB	SB
HCM Control Delay, s	17.6	1.4	0
HCM LOS	C		

Minor Lane/Major Mvmt	NBL	NBT	EBLn1	SBT	SBR
Capacity (veh/h)	1023	-	435	-	-
HCM Lane V/C Ratio	0.061	-	0.345	-	-
HCM Control Delay (s)	8.7	0	17.6	-	-
HCM Lane LOS	A	A	C	-	-
HCM 95th %tile Q(veh)	0.2	-	1.5	-	-

Intersection						
Int Delay, s/veh	0.3					
Movement	EBL	EBR	NBL	NBT	SBT	SBR
Lane Configurations	T			T		
Traffic Vol, veh/h	3	9	10	342	582	2
Future Vol, veh/h	3	9	10	342	582	2
Conflicting Peds, #/hr	0	0	0	0	0	0
Sign Control	Stop	Stop	Free	Free	Free	Free
RT Channelized	-	None	-	None	-	None
Storage Length	0	-	-	-	-	-
Veh in Median Storage, #	0	-	-	0	0	-
Grade, %	0	-	-	0	0	-
Peak Hour Factor	89	89	89	89	89	89
Heavy Vehicles, %	2	2	2	2	2	2
Mvmt Flow	3	10	11	384	654	2

Major/Minor	Minor2	Major1	Major2			
Conflicting Flow All	1061	655	656	0	-	0
Stage 1	655	-	-	-	-	-
Stage 2	406	-	-	-	-	-
Critical Hdwy	6.42	6.22	4.12	-	-	-
Critical Hdwy Stg 1	5.42	-	-	-	-	-
Critical Hdwy Stg 2	5.42	-	-	-	-	-
Follow-up Hdwy	3.518	3.318	2.218	-	-	-
Pot Cap-1 Maneuver	248	466	931	-	-	-
Stage 1	517	-	-	-	-	-
Stage 2	673	-	-	-	-	-
Platoon blocked, %				-	-	-
Mov Cap-1 Maneuver	244	466	931	-	-	-
Mov Cap-2 Maneuver	244	-	-	-	-	-
Stage 1	509	-	-	-	-	-
Stage 2	673	-	-	-	-	-

Approach	EB	NB	SB
HCM Control Delay, s	14.8	0.3	0
HCM LOS	B		

Minor Lane/Major Mvmt	NBL	NBT	EBLn1	SBT	SBR
Capacity (veh/h)	931	-	380	-	-
HCM Lane V/C Ratio	0.012	-	0.035	-	-
HCM Control Delay (s)	8.9	0	14.8	-	-
HCM Lane LOS	A	A	B	-	-
HCM 95th %tile Q(veh)	0	-	0.1	-	-

HCM 6th Signalized Intersection Summary
5: Rays Rd & Memorial Dr

Spivey Lake Residential
Existing PM



Movement	EBU	EBL	EBT	EBR	WBU	WBL	WBT	WBR	NBL	NBT	NBR	SBL
Lane Configurations		⇌	⇌	⇌		⇌	⇌	⇌	⇌	⇌		⇌
Traffic Volume (veh/h)	9	177	1254	67	13	36	1058	121	56	76	38	160
Future Volume (veh/h)	9	177	1254	67	13	36	1058	121	56	76	38	160
Initial Q (Qb), veh		0	0	0		0	0	0	0	0	0	0
Ped-Bike Adj(A_pbT)		1.00		1.00		1.00		1.00	1.00		1.00	1.00
Parking Bus, Adj		1.00	1.00	1.00		1.00	1.00	1.00	1.00	1.00	1.00	1.00
Work Zone On Approach			No				No			No		
Adj Sat Flow, veh/h/ln		1870	1870	1870		1870	1870	1870	1870	1870	1870	1870
Adj Flow Rate, veh/h		186	1320	0		38	1114	0	59	80	40	168
Peak Hour Factor		0.95	0.95	0.95		0.95	0.95	0.95	0.95	0.95	0.95	0.95
Percent Heavy Veh, %		2	2	2		2	2	2	2	2	2	2
Cap, veh/h		263	1825			115	1605		407	673	316	243
Arrive On Green		0.08	0.36	0.00		0.03	0.31	0.00	0.04	0.29	0.29	0.07
Sat Flow, veh/h		3456	5106	1585		3456	5106	1585	1781	2348	1101	3456
Grp Volume(v), veh/h		186	1320	0		38	1114	0	59	59	61	168
Grp Sat Flow(s),veh/h/ln		1728	1702	1585		1728	1702	1585	1781	1777	1672	1728
Q Serve(g_s), s		5.0	21.3	0.0		1.0	18.2	0.0	2.2	2.3	2.6	4.5
Cycle Q Clear(g_c), s		5.0	21.3	0.0		1.0	18.2	0.0	2.2	2.3	2.6	4.5
Prop In Lane		1.00		1.00		1.00		1.00	1.00		0.66	1.00
Lane Grp Cap(c), veh/h		263	1825			115	1605		407	509	479	243
V/C Ratio(X)		0.71	0.72			0.33	0.69		0.15	0.12	0.13	0.69
Avail Cap(c_a), veh/h		509	2953			182	2470		445	509	479	472
HCM Platoon Ratio		1.00	1.00	1.00		1.00	1.00	1.00	1.00	1.00	1.00	1.00
Upstream Filter(l)		1.00	1.00	0.00		1.00	1.00	0.00	1.00	1.00	1.00	1.00
Uniform Delay (d), s/veh		42.9	26.5	0.0		44.9	28.6	0.0	22.2	25.0	25.1	43.2
Incr Delay (d2), s/veh		3.5	0.6	0.0		1.7	0.5	0.0	0.2	0.5	0.5	3.5
Initial Q Delay(d3),s/veh		0.0	0.0	0.0		0.0	0.0	0.0	0.0	0.0	0.0	0.0
%ile BackOfQ(50%),veh/ln		2.2	8.1	0.0		0.4	7.0	0.0	0.9	1.0	1.1	2.0
Unsig. Movement Delay, s/veh												
LnGrp Delay(d),s/veh		46.3	27.0	0.0		46.6	29.1	0.0	22.4	25.5	25.7	46.7
LnGrp LOS		D	C			D	C		C	C	C	D
Approach Vol, veh/h			1506	A			1152	A		179		
Approach Delay, s/veh			29.4				29.7			24.5		
Approach LOS			C				C			C		
Timer - Assigned Phs	1	2	3	4	5	6	7	8				
Phs Duration (G+Y+Rc), s	13.2	35.9	9.9	36.0	9.2	40.0	12.7	33.3				
Change Period (Y+Rc), s	6.0	6.0	6.0	6.0	6.0	6.0	6.0	6.0				
Max Green Setting (Gmax), s	14.0	46.0	6.0	30.0	5.0	55.0	13.0	23.0				
Max Q Clear Time (g_c+I1), s	7.0	20.2	4.2	17.2	3.0	23.3	6.5	4.6				
Green Ext Time (p_c), s	0.3	8.0	0.0	1.7	0.0	10.7	0.3	0.5				

Intersection Summary

HCM 6th Ctrl Delay	30.1
HCM 6th LOS	C

Notes

User approved ignoring U-Turning movement.
Unsignalized Delay for [EBR, WBR] is excluded from calculations of the approach delay and intersection delay.

HCM 6th Signalized Intersection Summary
 5: Rays Rd & Memorial Dr

Spivey Lake Residential
 Existing PM



Movement	SBT	SBR
Lane Configurations	↑↑	↑
Traffic Volume (veh/h)	167	285
Future Volume (veh/h)	167	285
Initial Q (Qb), veh	0	0
Ped-Bike Adj(A_pbT)		1.00
Parking Bus, Adj	1.00	1.00
Work Zone On Approach	No	
Adj Sat Flow, veh/h/ln	1870	1870
Adj Flow Rate, veh/h	176	300
Peak Hour Factor	0.95	0.95
Percent Heavy Veh, %	2	2
Cap, veh/h	1121	500
Arrive On Green	0.32	0.32
Sat Flow, veh/h	3554	1585
Grp Volume(v), veh/h	176	300
Grp Sat Flow(s),veh/h/ln	1777	1585
Q Serve(g_s), s	3.4	15.2
Cycle Q Clear(g_c), s	3.4	15.2
Prop In Lane		1.00
Lane Grp Cap(c), veh/h	1121	500
V/C Ratio(X)	0.16	0.60
Avail Cap(c_a), veh/h	1121	500
HCM Platoon Ratio	1.00	1.00
Upstream Filter(l)	1.00	1.00
Uniform Delay (d), s/veh	23.4	27.5
Incr Delay (d2), s/veh	0.3	5.2
Initial Q Delay(d3),s/veh	0.0	0.0
%ile BackOfQ(50%),veh/ln	1.4	6.3
Unsig. Movement Delay, s/veh		
LnGrp Delay(d),s/veh	23.7	32.7
LnGrp LOS	C	C
Approach Vol, veh/h	644	
Approach Delay, s/veh	33.9	
Approach LOS	C	
Timer - Assigned Phs		

Intersection												
Int Delay, s/veh	4.6											
Movement	EBL	EBT	EBR	WBL	WBT	WBR	NBL	NBT	NBR	SBL	SBT	SBR
Lane Configurations		↕			↕			↕			↕	
Traffic Vol, veh/h	27	49	0	0	71	24	0	0	1	31	0	73
Future Vol, veh/h	27	49	0	0	71	24	0	0	1	31	0	73
Conflicting Peds, #/hr	0	0	0	0	0	0	0	0	0	0	0	0
Sign Control	Free	Free	Free	Free	Free	Free	Stop	Stop	Stop	Stop	Stop	Stop
RT Channelized	-	-	None	-	-	None	-	-	None	-	-	None
Storage Length	-	-	-	-	-	-	-	-	-	-	-	-
Veh in Median Storage, #	-	0	-	-	0	-	-	0	-	-	0	-
Grade, %	-	0	-	-	0	-	-	0	-	-	0	-
Peak Hour Factor	79	79	79	79	79	79	79	79	79	79	79	79
Heavy Vehicles, %	2	9	2	2	12	6	2	2	2	23	2	14
Mvmt Flow	34	62	0	0	90	30	0	0	1	39	0	92

Major/Minor	Major1		Major2		Minor1		Minor2					
Conflicting Flow All	120	0	0	62	0	0	281	250	62	236	235	105
Stage 1	-	-	-	-	-	-	130	130	-	105	105	-
Stage 2	-	-	-	-	-	-	151	120	-	131	130	-
Critical Hdwy	4.12	-	-	4.12	-	-	7.12	6.52	6.22	7.33	6.52	6.34
Critical Hdwy Stg 1	-	-	-	-	-	-	6.12	5.52	-	6.33	5.52	-
Critical Hdwy Stg 2	-	-	-	-	-	-	6.12	5.52	-	6.33	5.52	-
Follow-up Hdwy	2.218	-	-	2.218	-	-	3.518	4.018	3.318	3.707	4.018	3.426
Pot Cap-1 Maneuver	1468	-	-	1541	-	-	671	653	1003	677	666	918
Stage 1	-	-	-	-	-	-	874	789	-	852	808	-
Stage 2	-	-	-	-	-	-	851	796	-	825	789	-
Platoon blocked, %		-	-		-	-						
Mov Cap-1 Maneuver	1468	-	-	1541	-	-	592	637	1003	663	650	918
Mov Cap-2 Maneuver	-	-	-	-	-	-	592	637	-	663	650	-
Stage 1	-	-	-	-	-	-	853	770	-	832	808	-
Stage 2	-	-	-	-	-	-	765	796	-	804	770	-

Approach	EB		WB		NB		SB	
HCM Control Delay, s	2.7		0		8.6		10.2	
HCM LOS					A		B	

Minor Lane/Major Mvmt	NBLn1	EBL	EBT	EBR	WBL	WBT	WBR	SBLn1
Capacity (veh/h)	1003	1468	-	-	1541	-	-	824
HCM Lane V/C Ratio	0.001	0.023	-	-	-	-	-	0.16
HCM Control Delay (s)	8.6	7.5	0	-	0	-	-	10.2
HCM Lane LOS	A	A	A	-	A	-	-	B
HCM 95th %tile Q(veh)	0	0.1	-	-	0	-	-	0.6

Intersection						
Int Delay, s/veh	0					
Movement	EBT	EBR	WBL	WBT	NBL	NBR
Lane Configurations						
Traffic Vol, veh/h	83	0	0	98	0	0
Future Vol, veh/h	83	0	0	98	0	0
Conflicting Peds, #/hr	0	0	0	0	0	0
Sign Control	Free	Free	Free	Free	Stop	Stop
RT Channelized	-	None	-	None	-	None
Storage Length	-	-	-	-	0	-
Veh in Median Storage, #	0	-	-	0	0	-
Grade, %	0	-	-	0	0	-
Peak Hour Factor	92	92	92	92	92	92
Heavy Vehicles, %	2	2	2	2	2	2
Mvmt Flow	90	0	0	107	0	0
Major/Minor	Major1	Major2	Minor1			
Conflicting Flow All	0	0	90	0	197	90
Stage 1	-	-	-	-	90	-
Stage 2	-	-	-	-	107	-
Critical Hdwy	-	-	4.12	-	6.42	6.22
Critical Hdwy Stg 1	-	-	-	-	5.42	-
Critical Hdwy Stg 2	-	-	-	-	5.42	-
Follow-up Hdwy	-	-	2.218	-	3.518	3.318
Pot Cap-1 Maneuver	-	-	1505	-	792	968
Stage 1	-	-	-	-	934	-
Stage 2	-	-	-	-	917	-
Platoon blocked, %	-	-	-	-	-	-
Mov Cap-1 Maneuver	-	-	1505	-	792	968
Mov Cap-2 Maneuver	-	-	-	-	792	-
Stage 1	-	-	-	-	934	-
Stage 2	-	-	-	-	917	-
Approach	EB	WB	NB			
HCM Control Delay, s	0	0	0			
HCM LOS					A	
Minor Lane/Major Mvmt	NBLn1	EBT	EBR	WBL	WBT	
Capacity (veh/h)	-	-	-	1505	-	
HCM Lane V/C Ratio	-	-	-	-	-	
HCM Control Delay (s)	0	-	-	0	-	
HCM Lane LOS	A	-	-	A	-	
HCM 95th %tile Q(veh)	-	-	-	0	-	

Intersection						
Int Delay, s/veh	1.9					
Movement	EBL	EBR	NBL	NBT	SBT	SBR
Lane Configurations	T		T		T	
Traffic Vol, veh/h	15	46	67	225	340	28
Future Vol, veh/h	15	46	67	225	340	28
Conflicting Peds, #/hr	0	0	0	0	0	0
Sign Control	Stop	Stop	Free	Free	Free	Free
RT Channelized	-	None	-	None	-	None
Storage Length	0	-	-	-	-	-
Veh in Median Storage, #	0	-	-	0	0	-
Grade, %	0	-	-	0	0	-
Peak Hour Factor	88	88	88	88	88	88
Heavy Vehicles, %	2	3	2	6	8	2
Mvmt Flow	17	52	76	256	386	32

Major/Minor	Minor2	Major1	Major2			
Conflicting Flow All	810	402	418	0	-	0
Stage 1	402	-	-	-	-	-
Stage 2	408	-	-	-	-	-
Critical Hdwy	6.42	6.23	4.12	-	-	-
Critical Hdwy Stg 1	5.42	-	-	-	-	-
Critical Hdwy Stg 2	5.42	-	-	-	-	-
Follow-up Hdwy	3.518	3.327	2.218	-	-	-
Pot Cap-1 Maneuver	349	646	1141	-	-	-
Stage 1	676	-	-	-	-	-
Stage 2	671	-	-	-	-	-
Platoon blocked, %				-	-	-
Mov Cap-1 Maneuver	322	646	1141	-	-	-
Mov Cap-2 Maneuver	322	-	-	-	-	-
Stage 1	623	-	-	-	-	-
Stage 2	671	-	-	-	-	-

Approach	EB	NB	SB
HCM Control Delay, s	13	1.9	0
HCM LOS	B		

Minor Lane/Major Mvmt	NBL	NBT	EBLn1	SBT	SBR
Capacity (veh/h)	1141	-	518	-	-
HCM Lane V/C Ratio	0.067	-	0.134	-	-
HCM Control Delay (s)	8.4	0	13	-	-
HCM Lane LOS	A	A	B	-	-
HCM 95th %tile Q(veh)	0.2	-	0.5	-	-

Intersection						
Int Delay, s/veh	0.1					
Movement	EBL	EBR	NBL	NBT	SBT	SBR
Lane Configurations	T			T		
Traffic Vol, veh/h	3	4	1	273	399	1
Future Vol, veh/h	3	4	1	273	399	1
Conflicting Peds, #/hr	0	0	0	0	0	0
Sign Control	Stop	Stop	Free	Free	Free	Free
RT Channelized	-	None	-	None	-	None
Storage Length	0	-	-	-	-	-
Veh in Median Storage, #	0	-	-	0	0	-
Grade, %	0	-	-	0	0	-
Peak Hour Factor	90	90	90	90	90	90
Heavy Vehicles, %	2	2	2	6	7	2
Mvmt Flow	3	4	1	303	443	1

Major/Minor	Minor2	Major1		Major2	
Conflicting Flow All	749	444	444	0	0
Stage 1	444	-	-	-	-
Stage 2	305	-	-	-	-
Critical Hdwy	6.42	6.22	4.12	-	-
Critical Hdwy Stg 1	5.42	-	-	-	-
Critical Hdwy Stg 2	5.42	-	-	-	-
Follow-up Hdwy	3.518	3.318	2.218	-	-
Pot Cap-1 Maneuver	379	614	1116	-	-
Stage 1	646	-	-	-	-
Stage 2	748	-	-	-	-
Platoon blocked, %				-	-
Mov Cap-1 Maneuver	379	614	1116	-	-
Mov Cap-2 Maneuver	379	-	-	-	-
Stage 1	645	-	-	-	-
Stage 2	748	-	-	-	-

Approach	EB	NB	SB
HCM Control Delay, s	12.5	0	0
HCM LOS	B		

Minor Lane/Major Mvmt	NBL	NBT	EBLn1	SBT	SBR
Capacity (veh/h)	1116	-	485	-	-
HCM Lane V/C Ratio	0.001	-	0.016	-	-
HCM Control Delay (s)	8.2	0	12.5	-	-
HCM Lane LOS	A	A	B	-	-
HCM 95th %tile Q(veh)	0	-	0	-	-

HCM 6th Signalized Intersection Summary
5: Rays Rd & Memorial Dr

Spivey Lake Residential
Existing AM (Baseline)



Movement	EBU	EBL	EBT	EBR	WBU	WBL	WBT	WBR	NBL	NBT	NBR	SBL
Lane Configurations		2T	3T	T		2T	3T	T	T	2T		2T
Traffic Volume (veh/h)	8	104	732	42	14	14	1186	81	50	95	18	66
Future Volume (veh/h)	8	104	732	42	14	14	1186	81	50	95	18	66
Initial Q (Qb), veh		0	0	0		0	0	0	0	0	0	0
Ped-Bike Adj(A_pbT)		1.00		1.00		1.00		1.00	1.00		1.00	1.00
Parking Bus, Adj		1.00	1.00	1.00		1.00	1.00	1.00	1.00	1.00	1.00	1.00
Work Zone On Approach			No				No			No		
Adj Sat Flow, veh/h/ln		1752	1796	1856		1752	1826	1796	1870	1870	1870	1737
Adj Flow Rate, veh/h		107	755	0		14	1223	0	52	98	19	68
Peak Hour Factor		0.97	0.97	0.97		0.97	0.97	0.97	0.97	0.97	0.97	0.97
Percent Heavy Veh, %		10	7	3		10	5	7	2	2	2	11
Cap, veh/h		168	1832			53	1685		471	917	173	143
Arrive On Green		0.05	0.37	0.00		0.02	0.34	0.00	0.04	0.31	0.31	0.04
Sat Flow, veh/h		3237	4904	1572		3237	4985	1522	1781	2982	564	3209
Grp Volume(v), veh/h		107	755	0		14	1223	0	52	57	60	68
Grp Sat Flow(s),veh/h/ln		1618	1635	1572		1618	1662	1522	1781	1777	1769	1605
Q Serve(g_s), s		3.0	10.6	0.0		0.4	20.0	0.0	1.8	2.1	2.2	1.9
Cycle Q Clear(g_c), s		3.0	10.6	0.0		0.4	20.0	0.0	1.8	2.1	2.2	1.9
Prop In Lane		1.00		1.00		1.00		1.00	1.00		0.32	1.00
Lane Grp Cap(c), veh/h		168	1832			53	1685		471	546	544	143
V/C Ratio(X)		0.64	0.41			0.27	0.73		0.11	0.11	0.11	0.48
Avail Cap(c_a), veh/h		383	2903			244	2736		496	546	544	276
HCM Platoon Ratio		1.00	1.00	1.00		1.00	1.00	1.00	1.00	1.00	1.00	1.00
Upstream Filter(l)		1.00	1.00	0.00		1.00	1.00	0.00	1.00	1.00	1.00	1.00
Uniform Delay (d), s/veh		43.2	21.6	0.0		45.1	27.0	0.0	20.4	23.0	23.1	43.3
Incr Delay (d2), s/veh		4.0	0.1	0.0		2.6	0.6	0.0	0.1	0.4	0.4	2.4
Initial Q Delay(d3),s/veh		0.0	0.0	0.0		0.0	0.0	0.0	0.0	0.0	0.0	0.0
%ile BackOfQ(50%),veh/ln		1.2	3.8	0.0		0.2	7.4	0.0	0.7	0.9	1.0	0.8
Unsig. Movement Delay, s/veh												
LnGrp Delay(d),s/veh		47.2	21.7	0.0		47.8	27.6	0.0	20.5	23.4	23.5	45.8
LnGrp LOS		D	C			D	C		C	C	C	D
Approach Vol, veh/h			862	A			1237	A		169		
Approach Delay, s/veh			24.9				27.8			22.5		
Approach LOS			C				C			C		
Timer - Assigned Phs	1	2	3	4	5	6	7	8				
Phs Duration (G+Y+Rc), s	10.8	37.4	9.7	35.0	7.5	40.7	10.1	34.6				
Change Period (Y+Rc), s	6.0	6.0	6.0	6.0	6.0	6.0	6.0	6.0				
Max Green Setting (Gmax), s	11.0	51.0	5.0	29.0	7.0	55.0	8.0	26.0				
Max Q Clear Time (g_c+I1), s	5.0	22.0	3.8	15.2	2.4	12.6	3.9	4.2				
Green Ext Time (p_c), s	0.1	9.4	0.0	1.0	0.0	5.5	0.0	0.5				

Intersection Summary

HCM 6th Ctrl Delay	27.2
HCM 6th LOS	C

Notes

User approved ignoring U-Turning movement.
Unsignalized Delay for [EBR, WBR] is excluded from calculations of the approach delay and intersection delay.

HCM 6th Signalized Intersection Summary
 5: Rays Rd & Memorial Dr

Spivey Lake Residential
 Existing AM (Baseline)



Movement	SBT	SBR
Lane Configurations	↑↑	↑
Traffic Volume (veh/h)	50	252
Future Volume (veh/h)	50	252
Initial Q (Qb), veh	0	0
Ped-Bike Adj(A_pbT)		1.00
Parking Bus, Adj	1.00	1.00
Work Zone On Approach	No	
Adj Sat Flow, veh/h/ln	1870	1796
Adj Flow Rate, veh/h	52	260
Peak Hour Factor	0.97	0.97
Percent Heavy Veh, %	2	7
Cap, veh/h	1109	475
Arrive On Green	0.31	0.31
Sat Flow, veh/h	3554	1522
Grp Volume(v), veh/h	52	260
Grp Sat Flow(s),veh/h/ln	1777	1522
Q Serve(g_s), s	0.9	13.2
Cycle Q Clear(g_c), s	0.9	13.2
Prop In Lane		1.00
Lane Grp Cap(c), veh/h	1109	475
V/C Ratio(X)	0.05	0.55
Avail Cap(c_a), veh/h	1109	475
HCM Platoon Ratio	1.00	1.00
Upstream Filter(l)	1.00	1.00
Uniform Delay (d), s/veh	22.3	26.5
Incr Delay (d2), s/veh	0.1	4.5
Initial Q Delay(d3),s/veh	0.0	0.0
%ile BackOfQ(50%),veh/ln	0.4	5.2
Unsig. Movement Delay, s/veh		
LnGrp Delay(d),s/veh	22.4	31.0
LnGrp LOS	C	C
Approach Vol, veh/h	380	
Approach Delay, s/veh	32.5	
Approach LOS	C	
Timer - Assigned Phs		

Intersection												
Int Delay, s/veh	1.5											
Movement	EBL	EBT	EBR	WBL	WBT	WBR	NBL	NBT	NBR	SBL	SBT	SBR
Lane Configurations		↕			↕			↕			↕	
Traffic Vol, veh/h	13	133	0	0	67	8	0	1	1	12	1	12
Future Vol, veh/h	13	133	0	0	67	8	0	1	1	12	1	12
Conflicting Peds, #/hr	0	0	0	0	0	0	0	0	0	0	0	0
Sign Control	Free	Free	Free	Free	Free	Free	Stop	Stop	Stop	Stop	Stop	Stop
RT Channelized	-	-	None	-	-	None	-	-	None	-	-	None
Storage Length	-	-	-	-	-	-	-	-	-	-	-	-
Veh in Median Storage, #	-	0	-	-	0	-	-	0	-	-	0	-
Grade, %	-	0	-	-	0	-	-	0	-	-	0	-
Peak Hour Factor	91	91	91	91	91	91	91	91	91	91	91	91
Heavy Vehicles, %	8	2	2	2	3	2	2	2	2	2	2	2
Mvmt Flow	14	146	0	0	74	9	0	1	1	13	1	13

Major/Minor	Major1			Major2			Minor1			Minor2		
Conflicting Flow All	83	0	0	146	0	0	260	257	146	254	253	79
Stage 1	-	-	-	-	-	-	174	174	-	79	79	-
Stage 2	-	-	-	-	-	-	86	83	-	175	174	-
Critical Hdwy	4.18	-	-	4.12	-	-	7.12	6.52	6.22	7.12	6.52	6.22
Critical Hdwy Stg 1	-	-	-	-	-	-	6.12	5.52	-	6.12	5.52	-
Critical Hdwy Stg 2	-	-	-	-	-	-	6.12	5.52	-	6.12	5.52	-
Follow-up Hdwy	2.272	-	-	2.218	-	-	3.518	4.018	3.318	3.518	4.018	3.318
Pot Cap-1 Maneuver	1477	-	-	1436	-	-	693	647	901	699	650	981
Stage 1	-	-	-	-	-	-	828	755	-	930	829	-
Stage 2	-	-	-	-	-	-	922	826	-	827	755	-
Platoon blocked, %	-	-	-	-	-	-	-	-	-	-	-	-
Mov Cap-1 Maneuver	1477	-	-	1436	-	-	678	641	901	692	644	981
Mov Cap-2 Maneuver	-	-	-	-	-	-	678	641	-	692	644	-
Stage 1	-	-	-	-	-	-	820	747	-	921	829	-
Stage 2	-	-	-	-	-	-	908	826	-	817	747	-

Approach	EB			WB			NB			SB		
HCM Control Delay, s	0.7			0			9.8			9.6		
HCM LOS							A			A		

Minor Lane/Major Mvmt	NBLn1	EBL	EBT	EBR	WBL	WBT	WBR	SBLn1
Capacity (veh/h)	749	1477	-	-	1436	-	-	803
HCM Lane V/C Ratio	0.003	0.01	-	-	-	-	-	0.034
HCM Control Delay (s)	9.8	7.5	0	-	0	-	-	9.6
HCM Lane LOS	A	A	A	-	A	-	-	A
HCM 95th %tile Q(veh)	0	0	-	-	0	-	-	0.1

Intersection						
Int Delay, s/veh	0					
Movement	EBT	EBR	WBL	WBT	NBL	NBR
Lane Configurations						
Traffic Vol, veh/h	150	0	0	84	0	0
Future Vol, veh/h	150	0	0	84	0	0
Conflicting Peds, #/hr	0	0	0	0	0	0
Sign Control	Free	Free	Free	Free	Stop	Stop
RT Channelized	-	None	-	None	-	None
Storage Length	-	-	-	-	0	-
Veh in Median Storage, #	0	-	-	0	0	-
Grade, %	0	-	-	0	0	-
Peak Hour Factor	92	92	92	92	92	92
Heavy Vehicles, %	2	2	2	2	2	2
Mvmt Flow	163	0	0	91	0	0

Major/Minor	Major1	Major2	Minor1		
Conflicting Flow All	0	0	163	0	254
Stage 1	-	-	-	-	163
Stage 2	-	-	-	-	91
Critical Hdwy	-	-	4.12	-	6.42
Critical Hdwy Stg 1	-	-	-	-	5.42
Critical Hdwy Stg 2	-	-	-	-	5.42
Follow-up Hdwy	-	-	2.218	-	3.518
Pot Cap-1 Maneuver	-	-	1416	-	735
Stage 1	-	-	-	-	866
Stage 2	-	-	-	-	933
Platoon blocked, %	-	-	-	-	-
Mov Cap-1 Maneuver	-	-	1416	-	735
Mov Cap-2 Maneuver	-	-	-	-	735
Stage 1	-	-	-	-	866
Stage 2	-	-	-	-	933

Approach	EB	WB	NB
HCM Control Delay, s	0	0	0
HCM LOS			A

Minor Lane/Major Mvmt	NBLn1	EBT	EBR	WBL	WBT
Capacity (veh/h)	-	-	-	1416	-
HCM Lane V/C Ratio	-	-	-	-	-
HCM Control Delay (s)	0	-	-	0	-
HCM Lane LOS	A	-	-	A	-
HCM 95th %tile Q(veh)	-	-	-	0	-

Intersection						
Int Delay, s/veh	3.1					
Movement	EBL	EBR	NBL	NBT	SBT	SBR
Lane Configurations	T			T		
Traffic Vol, veh/h	33	112	60	308	505	22
Future Vol, veh/h	33	112	60	308	505	22
Conflicting Peds, #/hr	0	0	0	0	0	0
Sign Control	Stop	Stop	Free	Free	Free	Free
RT Channelized	-	None	-	None	-	None
Storage Length	0	-	-	-	-	-
Veh in Median Storage, #	0	-	-	0	0	-
Grade, %	0	-	-	0	0	-
Peak Hour Factor	92	92	92	92	92	92
Heavy Vehicles, %	2	2	2	2	2	5
Mvmt Flow	36	122	65	335	549	24

Major/Minor	Minor2	Major1	Major2			
Conflicting Flow All	1026	561	573	0	-	0
Stage 1	561	-	-	-	-	-
Stage 2	465	-	-	-	-	-
Critical Hdwy	6.42	6.22	4.12	-	-	-
Critical Hdwy Stg 1	5.42	-	-	-	-	-
Critical Hdwy Stg 2	5.42	-	-	-	-	-
Follow-up Hdwy	3.518	3.318	2.218	-	-	-
Pot Cap-1 Maneuver	260	527	1000	-	-	-
Stage 1	571	-	-	-	-	-
Stage 2	632	-	-	-	-	-
Platoon blocked, %				-	-	-
Mov Cap-1 Maneuver	239	527	1000	-	-	-
Mov Cap-2 Maneuver	239	-	-	-	-	-
Stage 1	525	-	-	-	-	-
Stage 2	632	-	-	-	-	-

Approach	EB	NB	SB
HCM Control Delay, s	18.9	1.4	0
HCM LOS	C		

Minor Lane/Major Mvmt	NBL	NBT	EBLn1	SBT	SBR
Capacity (veh/h)	1000	-	414	-	-
HCM Lane V/C Ratio	0.065	-	0.381	-	-
HCM Control Delay (s)	8.9	0	18.9	-	-
HCM Lane LOS	A	A	C	-	-
HCM 95th %tile Q(veh)	0.2	-	1.7	-	-

Intersection						
Int Delay, s/veh	0.3					
Movement	EBL	EBR	NBL	NBT	SBT	SBR
Lane Configurations	T		T		T	
Traffic Vol, veh/h	3	9	11	359	611	2
Future Vol, veh/h	3	9	11	359	611	2
Conflicting Peds, #/hr	0	0	0	0	0	0
Sign Control	Stop	Stop	Free	Free	Free	Free
RT Channelized	-	None	-	None	-	None
Storage Length	0	-	-	-	-	-
Veh in Median Storage, #	0	-	-	0	0	-
Grade, %	0	-	-	0	0	-
Peak Hour Factor	89	89	89	89	89	89
Heavy Vehicles, %	2	2	2	2	2	2
Mvmt Flow	3	10	12	403	687	2

Major/Minor	Minor2	Major1	Major2			
Conflicting Flow All	1115	688	689	0	-	0
Stage 1	688	-	-	-	-	-
Stage 2	427	-	-	-	-	-
Critical Hdwy	6.42	6.22	4.12	-	-	-
Critical Hdwy Stg 1	5.42	-	-	-	-	-
Critical Hdwy Stg 2	5.42	-	-	-	-	-
Follow-up Hdwy	3.518	3.318	2.218	-	-	-
Pot Cap-1 Maneuver	230	446	905	-	-	-
Stage 1	499	-	-	-	-	-
Stage 2	658	-	-	-	-	-
Platoon blocked, %				-	-	-
Mov Cap-1 Maneuver	226	446	905	-	-	-
Mov Cap-2 Maneuver	226	-	-	-	-	-
Stage 1	491	-	-	-	-	-
Stage 2	658	-	-	-	-	-

Approach	EB	NB	SB
HCM Control Delay, s	15.4	0.3	0
HCM LOS	C		

Minor Lane/Major Mvmt	NBL	NBT	EBLn1	SBT	SBR
Capacity (veh/h)	905	-	359	-	-
HCM Lane V/C Ratio	0.014	-	0.038	-	-
HCM Control Delay (s)	9	0	15.4	-	-
HCM Lane LOS	A	A	C	-	-
HCM 95th %tile Q(veh)	0	-	0.1	-	-

HCM 6th Signalized Intersection Summary
5: Rays Rd & Memorial Dr

Spivey Lake Residential
Existing PM (Baseline)



Movement	EBU	EBL	EBT	EBR	WBU	WBL	WBT	WBR	NBL	NBT	NBR	SBL
Lane Configurations		↔↔	↑↑↑	↗		↔↔	↑↑↑	↗	↖	↑↑		↖↖
Traffic Volume (veh/h)	9	186	1317	70	14	38	1111	127	59	80	40	168
Future Volume (veh/h)	9	186	1317	70	14	38	1111	127	59	80	40	168
Initial Q (Qb), veh		0	0	0		0	0	0	0	0	0	0
Ped-Bike Adj(A_pbT)		1.00		1.00		1.00		1.00	1.00		1.00	1.00
Parking Bus, Adj		1.00	1.00	1.00		1.00	1.00	1.00	1.00	1.00	1.00	1.00
Work Zone On Approach			No				No			No		
Adj Sat Flow, veh/h/ln		1870	1870	1870		1870	1870	1870	1870	1870	1870	1870
Adj Flow Rate, veh/h		196	1386	0		40	1169	0	62	84	42	177
Peak Hour Factor		0.95	0.95	0.95		0.95	0.95	0.95	0.95	0.95	0.95	0.95
Percent Heavy Veh, %		2	2	2		2	2	2	2	2	2	2
Cap, veh/h		271	1872			117	1643		396	666	313	250
Arrive On Green		0.08	0.37	0.00		0.03	0.32	0.00	0.04	0.28	0.28	0.07
Sat Flow, veh/h		3456	5106	1585		3456	5106	1585	1781	2347	1102	3456
Grp Volume(v), veh/h		196	1386	0		40	1169	0	62	62	64	177
Grp Sat Flow(s),veh/h/ln		1728	1702	1585		1728	1702	1585	1781	1777	1672	1728
Q Serve(g_s), s		5.5	23.3	0.0		1.1	19.8	0.0	2.4	2.6	2.8	4.9
Cycle Q Clear(g_c), s		5.5	23.3	0.0		1.1	19.8	0.0	2.4	2.6	2.8	4.9
Prop In Lane		1.00		1.00		1.00		1.00	1.00		0.66	1.00
Lane Grp Cap(c), veh/h		271	1872			117	1643		396	504	474	250
V/C Ratio(X)		0.72	0.74			0.34	0.71		0.16	0.12	0.13	0.71
Avail Cap(c_a), veh/h		491	2747			210	2332		431	504	474	456
HCM Platoon Ratio		1.00	1.00	1.00		1.00	1.00	1.00	1.00	1.00	1.00	1.00
Upstream Filter(l)		1.00	1.00	0.00		1.00	1.00	0.00	1.00	1.00	1.00	1.00
Uniform Delay (d), s/veh		44.3	27.1	0.0		46.5	29.4	0.0	23.2	26.2	26.3	44.7
Incr Delay (d2), s/veh		3.6	0.6	0.0		1.7	0.6	0.0	0.2	0.5	0.6	3.6
Initial Q Delay(d3),s/veh		0.0	0.0	0.0		0.0	0.0	0.0	0.0	0.0	0.0	0.0
%ile BackOfQ(50%),veh/ln		2.4	8.8	0.0		0.5	7.7	0.0	1.0	1.1	1.2	2.2
Unsig. Movement Delay, s/veh												
LnGrp Delay(d),s/veh		48.0	27.7	0.0		48.3	30.0	0.0	23.4	26.7	26.9	48.3
LnGrp LOS		D	C			D	C		C	C	C	D
Approach Vol, veh/h			1582	A			1209	A		188		
Approach Delay, s/veh			30.2				30.6			25.7		
Approach LOS			C				C			C		
Timer - Assigned Phs	1	2	3	4	5	6	7	8				
Phs Duration (G+Y+Rc), s	13.7	37.7	10.1	37.0	9.3	42.1	13.1	33.9				
Change Period (Y+Rc), s	6.0	6.0	6.0	6.0	6.0	6.0	6.0	6.0				
Max Green Setting (Gmax), s	14.0	45.0	6.0	31.0	6.0	53.0	13.0	24.0				
Max Q Clear Time (g_c+I1), s	7.5	21.8	4.4	18.7	3.1	25.3	6.9	4.8				
Green Ext Time (p_c), s	0.3	8.2	0.0	1.8	0.0	10.9	0.3	0.6				

Intersection Summary

HCM 6th Ctrl Delay	31.1
HCM 6th LOS	C

Notes

User approved ignoring U-Turning movement.
Unsignalized Delay for [EBR, WBR] is excluded from calculations of the approach delay and intersection delay.

HCM 6th Signalized Intersection Summary
 5: Rays Rd & Memorial Dr

Spivey Lake Residential
 Existing PM (Baseline)



Movement	SBT	SBR
Lane Configurations	↑↑	↑
Traffic Volume (veh/h)	175	299
Future Volume (veh/h)	175	299
Initial Q (Qb), veh	0	0
Ped-Bike Adj(A_pbT)		1.00
Parking Bus, Adj	1.00	1.00
Work Zone On Approach	No	
Adj Sat Flow, veh/h/ln	1870	1870
Adj Flow Rate, veh/h	184	315
Peak Hour Factor	0.95	0.95
Percent Heavy Veh, %	2	2
Cap, veh/h	1118	499
Arrive On Green	0.31	0.31
Sat Flow, veh/h	3554	1585
Grp Volume(v), veh/h	184	315
Grp Sat Flow(s),veh/h/ln	1777	1585
Q Serve(g_s), s	3.7	16.7
Cycle Q Clear(g_c), s	3.7	16.7
Prop In Lane		1.00
Lane Grp Cap(c), veh/h	1118	499
V/C Ratio(X)	0.16	0.63
Avail Cap(c_a), veh/h	1118	499
HCM Platoon Ratio	1.00	1.00
Upstream Filter(l)	1.00	1.00
Uniform Delay (d), s/veh	24.4	28.9
Incr Delay (d2), s/veh	0.3	6.0
Initial Q Delay(d3),s/veh	0.0	0.0
%ile BackOfQ(50%),veh/ln	1.6	7.0
Unsig. Movement Delay, s/veh		
LnGrp Delay(d),s/veh	24.7	34.8
LnGrp LOS	C	C
Approach Vol, veh/h	676	
Approach Delay, s/veh	35.6	
Approach LOS	D	
Timer - Assigned Phs		

Intersection												
Int Delay, s/veh	4.7											
Movement	EBL	EBT	EBR	WBL	WBT	WBR	NBL	NBT	NBR	SBL	SBT	SBR
Lane Configurations		↕			↕			↕			↕	
Traffic Vol, veh/h	30	54	0	0	78	27	0	0	1	34	0	81
Future Vol, veh/h	30	54	0	0	78	27	0	0	1	34	0	81
Conflicting Peds, #/hr	0	0	0	0	0	0	0	0	0	0	0	0
Sign Control	Free	Free	Free	Free	Free	Free	Stop	Stop	Stop	Stop	Stop	Stop
RT Channelized	-	-	None	-	-	None	-	-	None	-	-	None
Storage Length	-	-	-	-	-	-	-	-	-	-	-	-
Veh in Median Storage, #	-	0	-	-	0	-	-	0	-	-	0	-
Grade, %	-	0	-	-	0	-	-	0	-	-	0	-
Peak Hour Factor	79	79	79	79	79	79	79	79	79	79	79	79
Heavy Vehicles, %	2	9	2	2	12	6	2	2	2	23	2	14
Mvmt Flow	38	68	0	0	99	34	0	0	1	43	0	103

Major/Minor	Major1		Major2		Minor1		Minor2					
Conflicting Flow All	133	0	0	68	0	0	312	277	68	261	260	116
Stage 1	-	-	-	-	-	-	144	144	-	116	116	-
Stage 2	-	-	-	-	-	-	168	133	-	145	144	-
Critical Hdwy	4.12	-	-	4.12	-	-	7.12	6.52	6.22	7.33	6.52	6.34
Critical Hdwy Stg 1	-	-	-	-	-	-	6.12	5.52	-	6.33	5.52	-
Critical Hdwy Stg 2	-	-	-	-	-	-	6.12	5.52	-	6.33	5.52	-
Follow-up Hdwy	2.218	-	-	2.218	-	-	3.518	4.018	3.318	3.707	4.018	3.426
Pot Cap-1 Maneuver	1452	-	-	1533	-	-	641	631	995	651	645	905
Stage 1	-	-	-	-	-	-	859	778	-	840	800	-
Stage 2	-	-	-	-	-	-	834	786	-	810	778	-
Platoon blocked, %		-	-		-	-						
Mov Cap-1 Maneuver	1452	-	-	1533	-	-	556	614	995	637	628	905
Mov Cap-2 Maneuver	-	-	-	-	-	-	556	614	-	637	628	-
Stage 1	-	-	-	-	-	-	836	757	-	817	800	-
Stage 2	-	-	-	-	-	-	740	786	-	787	757	-

Approach	EB		WB		NB		SB	
HCM Control Delay, s	2.7		0		8.6		10.5	
HCM LOS					A		B	

Minor Lane/Major Mvmt	NBLn1	EBL	EBT	EBR	WBL	WBT	WBR	SBLn1
Capacity (veh/h)	995	1452	-	-	1533	-	-	805
HCM Lane V/C Ratio	0.001	0.026	-	-	-	-	-	0.181
HCM Control Delay (s)	8.6	7.5	0	-	0	-	-	10.5
HCM Lane LOS	A	A	A	-	A	-	-	B
HCM 95th %tile Q(veh)	0	0.1	-	-	0	-	-	0.7

Intersection						
Int Delay, s/veh	0					
Movement	EBT	EBR	WBL	WBT	NBL	NBR
Lane Configurations						
Traffic Vol, veh/h	92	0	0	108	0	0
Future Vol, veh/h	92	0	0	108	0	0
Conflicting Peds, #/hr	0	0	0	0	0	0
Sign Control	Free	Free	Free	Free	Stop	Stop
RT Channelized	-	None	-	None	-	None
Storage Length	-	-	-	-	0	-
Veh in Median Storage, #	0	-	-	0	0	-
Grade, %	0	-	-	0	0	-
Peak Hour Factor	92	92	92	92	92	92
Heavy Vehicles, %	2	2	2	2	2	2
Mvmt Flow	100	0	0	117	0	0

Major/Minor	Major1	Major2	Minor1	Minor2	Minor3
Conflicting Flow All	0	0	100	0	217
Stage 1	-	-	-	-	100
Stage 2	-	-	-	-	117
Critical Hdwy	-	-	4.12	-	6.42
Critical Hdwy Stg 1	-	-	-	-	5.42
Critical Hdwy Stg 2	-	-	-	-	5.42
Follow-up Hdwy	-	-	2.218	-	3.518
Pot Cap-1 Maneuver	-	-	1493	-	771
Stage 1	-	-	-	-	924
Stage 2	-	-	-	-	908
Platoon blocked, %	-	-	-	-	-
Mov Cap-1 Maneuver	-	-	1493	-	771
Mov Cap-2 Maneuver	-	-	-	-	771
Stage 1	-	-	-	-	924
Stage 2	-	-	-	-	908

Approach	EB	WB	NB
HCM Control Delay, s	0	0	0
HCM LOS			A

Minor Lane/Major Mvmt	NBLn1	EBT	EBR	WBL	WBT
Capacity (veh/h)	-	-	-	1493	-
HCM Lane V/C Ratio	-	-	-	-	-
HCM Control Delay (s)	0	-	-	0	-
HCM Lane LOS	A	-	-	A	-
HCM 95th %tile Q(veh)	-	-	-	0	-

Intersection						
Int Delay, s/veh	2					
Movement	EBL	EBR	NBL	NBT	SBT	SBR
Lane Configurations	T			T		
Traffic Vol, veh/h	17	51	74	249	376	31
Future Vol, veh/h	17	51	74	249	376	31
Conflicting Peds, #/hr	0	0	0	0	0	0
Sign Control	Stop	Stop	Free	Free	Free	Free
RT Channelized	-	None	-	None	-	None
Storage Length	0	-	-	-	-	-
Veh in Median Storage, #	0	-	-	0	0	-
Grade, %	0	-	-	0	0	-
Peak Hour Factor	88	88	88	88	88	88
Heavy Vehicles, %	2	3	2	6	8	2
Mvmt Flow	19	58	84	283	427	35

Major/Minor	Minor2	Major1	Major2			
Conflicting Flow All	896	445	462	0	-	0
Stage 1	445	-	-	-	-	-
Stage 2	451	-	-	-	-	-
Critical Hdwy	6.42	6.23	4.12	-	-	-
Critical Hdwy Stg 1	5.42	-	-	-	-	-
Critical Hdwy Stg 2	5.42	-	-	-	-	-
Follow-up Hdwy	3.518	3.327	2.218	-	-	-
Pot Cap-1 Maneuver	311	611	1099	-	-	-
Stage 1	646	-	-	-	-	-
Stage 2	642	-	-	-	-	-
Platoon blocked, %				-	-	-
Mov Cap-1 Maneuver	283	611	1099	-	-	-
Mov Cap-2 Maneuver	283	-	-	-	-	-
Stage 1	587	-	-	-	-	-
Stage 2	642	-	-	-	-	-

Approach	EB	NB	SB
HCM Control Delay, s	14.1	2	0
HCM LOS	B		

Minor Lane/Major Mvmt	NBL	NBT	EBLn1	SBT	SBR
Capacity (veh/h)	1099	-	474	-	-
HCM Lane V/C Ratio	0.077	-	0.163	-	-
HCM Control Delay (s)	8.5	0	14.1	-	-
HCM Lane LOS	A	A	B	-	-
HCM 95th %tile Q(veh)	0.2	-	0.6	-	-

Intersection						
Int Delay, s/veh	0.1					
Movement	EBL	EBR	NBL	NBT	SBT	SBR
Lane Configurations	T			T		
Traffic Vol, veh/h	3	4	1	302	441	1
Future Vol, veh/h	3	4	1	302	441	1
Conflicting Peds, #/hr	0	0	0	0	0	0
Sign Control	Stop	Stop	Free	Free	Free	Free
RT Channelized	-	None	-	None	-	None
Storage Length	0	-	-	-	-	-
Veh in Median Storage, #	0	-	-	0	0	-
Grade, %	0	-	-	0	0	-
Peak Hour Factor	90	90	90	90	90	90
Heavy Vehicles, %	2	2	2	6	7	2
Mvmt Flow	3	4	1	336	490	1

Major/Minor	Minor2	Major1	Major2			
Conflicting Flow All	829	491	491	0	-	0
Stage 1	491	-	-	-	-	-
Stage 2	338	-	-	-	-	-
Critical Hdwy	6.42	6.22	4.12	-	-	-
Critical Hdwy Stg 1	5.42	-	-	-	-	-
Critical Hdwy Stg 2	5.42	-	-	-	-	-
Follow-up Hdwy	3.518	3.318	2.218	-	-	-
Pot Cap-1 Maneuver	340	578	1072	-	-	-
Stage 1	615	-	-	-	-	-
Stage 2	722	-	-	-	-	-
Platoon blocked, %				-	-	-
Mov Cap-1 Maneuver	340	578	1072	-	-	-
Mov Cap-2 Maneuver	340	-	-	-	-	-
Stage 1	614	-	-	-	-	-
Stage 2	722	-	-	-	-	-

Approach	EB	NB	SB
HCM Control Delay, s	13.2	0	0
HCM LOS	B		

Minor Lane/Major Mvmt	NBL	NBT	EBLn1	SBT	SBR
Capacity (veh/h)	1072	-	445	-	-
HCM Lane V/C Ratio	0.001	-	0.017	-	-
HCM Control Delay (s)	8.4	0	13.2	-	-
HCM Lane LOS	A	A	B	-	-
HCM 95th %tile Q(veh)	0	-	0.1	-	-

HCM 6th Signalized Intersection Summary
5: Rays Rd & Memorial Dr

Spivey Lake Residential
No Build AM



Movement	EBU	EBL	EBT	EBR	WBU	WBL	WBT	WBR	NBL	NBT	NBR	SBL
Lane Configurations		2T	3T	T		2T	3T	T	T	2T		2T
Traffic Volume (veh/h)	9	115	809	46	15	15	1311	90	55	105	20	73
Future Volume (veh/h)	9	115	809	46	15	15	1311	90	55	105	20	73
Initial Q (Qb), veh		0	0	0		0	0	0	0	0	0	0
Ped-Bike Adj(A_pbT)		1.00		1.00		1.00		1.00	1.00		1.00	1.00
Parking Bus, Adj		1.00	1.00	1.00		1.00	1.00	1.00	1.00	1.00	1.00	1.00
Work Zone On Approach			No				No			No		
Adj Sat Flow, veh/h/ln		1752	1796	1856		1752	1826	1796	1870	1870	1870	1737
Adj Flow Rate, veh/h		119	834	0		15	1352	0	57	108	21	75
Peak Hour Factor		0.97	0.97	0.97		0.97	0.97	0.97	0.97	0.97	0.97	0.97
Percent Heavy Veh, %		10	7	3		10	5	7	2	2	2	11
Cap, veh/h		179	1936			55	1777		451	909	173	140
Arrive On Green		0.06	0.39	0.00		0.02	0.36	0.00	0.04	0.31	0.31	0.04
Sat Flow, veh/h		3237	4904	1572		3237	4985	1522	1781	2980	565	3209
Grp Volume(v), veh/h		119	834	0		15	1352	0	57	63	66	75
Grp Sat Flow(s),veh/h/ln		1618	1635	1572		1618	1662	1522	1781	1777	1769	1605
Q Serve(g_s), s		3.6	12.4	0.0		0.5	24.0	0.0	2.2	2.6	2.7	2.3
Cycle Q Clear(g_c), s		3.6	12.4	0.0		0.5	24.0	0.0	2.2	2.6	2.7	2.3
Prop In Lane		1.00		1.00		1.00		1.00	1.00		0.32	1.00
Lane Grp Cap(c), veh/h		179	1936			55	1777		451	542	540	140
V/C Ratio(X)		0.67	0.43			0.27	0.76		0.13	0.12	0.12	0.53
Avail Cap(c_a), veh/h		355	2690			161	2436		469	542	540	224
HCM Platoon Ratio		1.00	1.00	1.00		1.00	1.00	1.00	1.00	1.00	1.00	1.00
Upstream Filter(l)		1.00	1.00	0.00		1.00	1.00	0.00	1.00	1.00	1.00	1.00
Uniform Delay (d), s/veh		46.5	22.1	0.0		48.7	28.5	0.0	22.2	25.1	25.1	46.9
Incr Delay (d2), s/veh		4.2	0.2	0.0		2.6	1.0	0.0	0.1	0.4	0.5	3.1
Initial Q Delay(d3),s/veh		0.0	0.0	0.0		0.0	0.0	0.0	0.0	0.0	0.0	0.0
%ile BackOfQ(50%),veh/ln		1.5	4.5	0.0		0.2	9.0	0.0	0.9	1.1	1.2	1.0
Unsig. Movement Delay, s/veh												
LnGrp Delay(d),s/veh		50.7	22.3	0.0		51.3	29.4	0.0	22.4	25.5	25.6	50.1
LnGrp LOS		D	C			D	C		C	C	C	D
Approach Vol, veh/h			953	A			1367	A		186		
Approach Delay, s/veh			25.8				29.7			24.6		
Approach LOS			C				C			C		
Timer - Assigned Phs	1	2	3	4	5	6	7	8				
Phs Duration (G+Y+Rc), s	11.5	41.8	10.0	37.0	7.7	45.6	10.4	36.6				
Change Period (Y+Rc), s	6.0	6.0	6.0	6.0	6.0	6.0	6.0	6.0				
Max Green Setting (Gmax), s	11.0	49.0	5.0	31.0	5.0	55.0	7.0	29.0				
Max Q Clear Time (g_c+I1), s	5.6	26.0	4.2	18.2	2.5	14.4	4.3	4.7				
Green Ext Time (p_c), s	0.1	9.7	0.0	1.1	0.0	6.2	0.0	0.6				

Intersection Summary

HCM 6th Ctrl Delay	29.1
HCM 6th LOS	C

Notes

User approved ignoring U-Turning movement.
Unsignalized Delay for [EBR, WBR] is excluded from calculations of the approach delay and intersection delay.

HCM 6th Signalized Intersection Summary
 5: Rays Rd & Memorial Dr

Spivey Lake Residential
 No Build AM



Movement	SBT	SBR
Lane Configurations	↑↑	↑
Traffic Volume (veh/h)	55	279
Future Volume (veh/h)	55	279
Initial Q (Qb), veh	0	0
Ped-Bike Adj(A_pbT)		1.00
Parking Bus, Adj	1.00	1.00
Work Zone On Approach	No	
Adj Sat Flow, veh/h/ln	1870	1796
Adj Flow Rate, veh/h	57	288
Peak Hour Factor	0.97	0.97
Percent Heavy Veh, %	2	7
Cap, veh/h	1099	471
Arrive On Green	0.31	0.31
Sat Flow, veh/h	3554	1522
Grp Volume(v), veh/h	57	288
Grp Sat Flow(s),veh/h/ln	1777	1522
Q Serve(g_s), s	1.1	16.2
Cycle Q Clear(g_c), s	1.1	16.2
Prop In Lane		1.00
Lane Grp Cap(c), veh/h	1099	471
V/C Ratio(X)	0.05	0.61
Avail Cap(c_a), veh/h	1099	471
HCM Platoon Ratio	1.00	1.00
Upstream Filter(l)	1.00	1.00
Uniform Delay (d), s/veh	24.3	29.5
Incr Delay (d2), s/veh	0.1	5.8
Initial Q Delay(d3),s/veh	0.0	0.0
%ile BackOfQ(50%),veh/ln	0.5	6.5
Unsig. Movement Delay, s/veh		
LnGrp Delay(d),s/veh	24.4	35.3
LnGrp LOS	C	D
Approach Vol, veh/h	420	
Approach Delay, s/veh	36.5	
Approach LOS	D	
Timer - Assigned Phs		

Intersection												
Int Delay, s/veh	1.5											
Movement	EBL	EBT	EBR	WBL	WBT	WBR	NBL	NBT	NBR	SBL	SBT	SBR
Lane Configurations		↕			↕			↕			↕	
Traffic Vol, veh/h	14	147	0	0	74	9	0	1	1	13	1	13
Future Vol, veh/h	14	147	0	0	74	9	0	1	1	13	1	13
Conflicting Peds, #/hr	0	0	0	0	0	0	0	0	0	0	0	0
Sign Control	Free	Free	Free	Free	Free	Free	Stop	Stop	Stop	Stop	Stop	Stop
RT Channelized	-	-	None	-	-	None	-	-	None	-	-	None
Storage Length	-	-	-	-	-	-	-	-	-	-	-	-
Veh in Median Storage, #	-	0	-	-	0	-	-	0	-	-	0	-
Grade, %	-	0	-	-	0	-	-	0	-	-	0	-
Peak Hour Factor	91	91	91	91	91	91	91	91	91	91	91	91
Heavy Vehicles, %	8	2	2	2	3	2	2	2	2	2	2	2
Mvmt Flow	15	162	0	0	81	10	0	1	1	14	1	14

Major/Minor	Major1		Major2			Minor1			Minor2			
Conflicting Flow All	91	0	0	162	0	0	286	283	162	279	278	86
Stage 1	-	-	-	-	-	-	192	192	-	86	86	-
Stage 2	-	-	-	-	-	-	94	91	-	193	192	-
Critical Hdwy	4.18	-	-	4.12	-	-	7.12	6.52	6.22	7.12	6.52	6.22
Critical Hdwy Stg 1	-	-	-	-	-	-	6.12	5.52	-	6.12	5.52	-
Critical Hdwy Stg 2	-	-	-	-	-	-	6.12	5.52	-	6.12	5.52	-
Follow-up Hdwy	2.272	-	-	2.218	-	-	3.518	4.018	3.318	3.518	4.018	3.318
Pot Cap-1 Maneuver	1467	-	-	1417	-	-	666	626	883	673	630	973
Stage 1	-	-	-	-	-	-	810	742	-	922	824	-
Stage 2	-	-	-	-	-	-	913	820	-	809	742	-
Platoon blocked, %	-	-	-	-	-	-	-	-	-	-	-	-
Mov Cap-1 Maneuver	1467	-	-	1417	-	-	650	619	883	666	623	973
Mov Cap-2 Maneuver	-	-	-	-	-	-	650	619	-	666	623	-
Stage 1	-	-	-	-	-	-	801	734	-	912	824	-
Stage 2	-	-	-	-	-	-	898	820	-	798	734	-

Approach	EB	WB	NB	SB
HCM Control Delay, s	0.7	0	10	9.8
HCM LOS			B	A

Minor Lane/Major Mvmt	NBLn1	EBL	EBT	EBR	WBL	WBT	WBR	SBLn1
Capacity (veh/h)	728	1467	-	-	1417	-	-	783
HCM Lane V/C Ratio	0.003	0.01	-	-	-	-	-	0.038
HCM Control Delay (s)	10	7.5	0	-	0	-	-	9.8
HCM Lane LOS	B	A	A	-	A	-	-	A
HCM 95th %tile Q(veh)	0	0	-	-	0	-	-	0.1

Intersection						
Int Delay, s/veh	0					
Movement	EBT	EBR	WBL	WBT	NBL	NBR
Lane Configurations						
Traffic Vol, veh/h	166	0	0	93	0	0
Future Vol, veh/h	166	0	0	93	0	0
Conflicting Peds, #/hr	0	0	0	0	0	0
Sign Control	Free	Free	Free	Free	Stop	Stop
RT Channelized	-	None	-	None	-	None
Storage Length	-	-	-	-	0	-
Veh in Median Storage, #	0	-	-	0	0	-
Grade, %	0	-	-	0	0	-
Peak Hour Factor	92	92	92	92	92	92
Heavy Vehicles, %	2	2	2	2	2	2
Mvmt Flow	180	0	0	101	0	0

Major/Minor	Major1	Major2	Minor1	Minor2	Minor3
Conflicting Flow All	0	0	180	0	281
Stage 1	-	-	-	-	180
Stage 2	-	-	-	-	101
Critical Hdwy	-	-	4.12	-	6.42
Critical Hdwy Stg 1	-	-	-	-	5.42
Critical Hdwy Stg 2	-	-	-	-	5.42
Follow-up Hdwy	-	-	2.218	-	3.518
Pot Cap-1 Maneuver	-	-	1396	-	709
Stage 1	-	-	-	-	851
Stage 2	-	-	-	-	923
Platoon blocked, %	-	-	-	-	-
Mov Cap-1 Maneuver	-	-	1396	-	709
Mov Cap-2 Maneuver	-	-	-	-	709
Stage 1	-	-	-	-	851
Stage 2	-	-	-	-	923

Approach	EB	WB	NB
HCM Control Delay, s	0	0	0
HCM LOS			A

Minor Lane/Major Mvmt	NBLn1	EBT	EBR	WBL	WBT
Capacity (veh/h)	-	-	-	1396	-
HCM Lane V/C Ratio	-	-	-	-	-
HCM Control Delay (s)	0	-	-	0	-
HCM Lane LOS	A	-	-	A	-
HCM 95th %tile Q(veh)	-	-	-	0	-

Intersection						
Int Delay, s/veh	3.7					
Movement	EBL	EBR	NBL	NBT	SBT	SBR
Lane Configurations	T		T		T	
Traffic Vol, veh/h	36	124	66	340	558	24
Future Vol, veh/h	36	124	66	340	558	24
Conflicting Peds, #/hr	0	0	0	0	0	0
Sign Control	Stop	Stop	Free	Free	Free	Free
RT Channelized	-	None	-	None	-	None
Storage Length	0	-	-	-	-	-
Veh in Median Storage, #	0	-	-	0	0	-
Grade, %	0	-	-	0	0	-
Peak Hour Factor	92	92	92	92	92	92
Heavy Vehicles, %	2	2	2	2	2	5
Mvmt Flow	39	135	72	370	607	26

Major/Minor	Minor2	Major1	Major2			
Conflicting Flow All	1134	620	633	0	-	0
Stage 1	620	-	-	-	-	-
Stage 2	514	-	-	-	-	-
Critical Hdwy	6.42	6.22	4.12	-	-	-
Critical Hdwy Stg 1	5.42	-	-	-	-	-
Critical Hdwy Stg 2	5.42	-	-	-	-	-
Follow-up Hdwy	3.518	3.318	2.218	-	-	-
Pot Cap-1 Maneuver	224	488	950	-	-	-
Stage 1	536	-	-	-	-	-
Stage 2	600	-	-	-	-	-
Platoon blocked, %				-	-	-
Mov Cap-1 Maneuver	203	488	950	-	-	-
Mov Cap-2 Maneuver	203	-	-	-	-	-
Stage 1	485	-	-	-	-	-
Stage 2	600	-	-	-	-	-

Approach	EB	NB	SB
HCM Control Delay, s	23	1.5	0
HCM LOS	C		

Minor Lane/Major Mvmt	NBL	NBT	EBLn1	SBT	SBR
Capacity (veh/h)	950	-	371	-	-
HCM Lane V/C Ratio	0.076	-	0.469	-	-
HCM Control Delay (s)	9.1	0	23	-	-
HCM Lane LOS	A	A	C	-	-
HCM 95th %tile Q(veh)	0.2	-	2.4	-	-

Intersection						
Int Delay, s/veh	0.3					
Movement	EBL	EBR	NBL	NBT	SBT	SBR
Lane Configurations	T			T		
Traffic Vol, veh/h	3	10	12	397	675	2
Future Vol, veh/h	3	10	12	397	675	2
Conflicting Peds, #/hr	0	0	0	0	0	0
Sign Control	Stop	Stop	Free	Free	Free	Free
RT Channelized	-	None	-	None	-	None
Storage Length	0	-	-	-	-	-
Veh in Median Storage, #	0	-	-	0	0	-
Grade, %	0	-	-	0	0	-
Peak Hour Factor	89	89	89	89	89	89
Heavy Vehicles, %	2	2	2	2	2	2
Mvmt Flow	3	11	13	446	758	2

Major/Minor	Minor2	Major1	Major2			
Conflicting Flow All	1231	759	760	0	-	0
Stage 1	759	-	-	-	-	-
Stage 2	472	-	-	-	-	-
Critical Hdwy	6.42	6.22	4.12	-	-	-
Critical Hdwy Stg 1	5.42	-	-	-	-	-
Critical Hdwy Stg 2	5.42	-	-	-	-	-
Follow-up Hdwy	3.518	3.318	2.218	-	-	-
Pot Cap-1 Maneuver	196	406	852	-	-	-
Stage 1	462	-	-	-	-	-
Stage 2	628	-	-	-	-	-
Platoon blocked, %				-	-	-
Mov Cap-1 Maneuver	192	406	852	-	-	-
Mov Cap-2 Maneuver	192	-	-	-	-	-
Stage 1	453	-	-	-	-	-
Stage 2	628	-	-	-	-	-

Approach	EB	NB	SB
HCM Control Delay, s	16.7	0.3	0
HCM LOS	C		

Minor Lane/Major Mvmt	NBL	NBT	EBLn1	SBT	SBR
Capacity (veh/h)	852	-	323	-	-
HCM Lane V/C Ratio	0.016	-	0.045	-	-
HCM Control Delay (s)	9.3	0	16.7	-	-
HCM Lane LOS	A	A	C	-	-
HCM 95th %tile Q(veh)	0	-	0.1	-	-

HCM 6th Signalized Intersection Summary
5: Rays Rd & Memorial Dr

Spivey Lake Residential
No Build PM

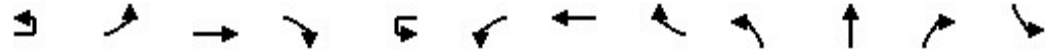

Movement	EBU	EBL	EBT	EBR	WBU	WBL	WBT	WBR	NBL	NBT	NBR	SBL
Lane Configurations		↔	↔	↔		↔	↔	↔	↔	↔		↔
Traffic Volume (veh/h)	10	206	1456	77	15	42	1228	140	65	88	44	186
Future Volume (veh/h)	10	206	1456	77	15	42	1228	140	65	88	44	186
Initial Q (Qb), veh		0	0	0		0	0	0	0	0	0	0
Ped-Bike Adj(A_pbT)		1.00		1.00		1.00		1.00	1.00		1.00	1.00
Parking Bus, Adj		1.00	1.00	1.00		1.00	1.00	1.00	1.00	1.00	1.00	1.00
Work Zone On Approach			No				No			No		
Adj Sat Flow, veh/h/ln		1870	1870	1870		1870	1870	1870	1870	1870	1870	1870
Adj Flow Rate, veh/h		217	1533	0		44	1293	0	68	93	46	196
Peak Hour Factor		0.95	0.95	0.95		0.95	0.95	0.95	0.95	0.95	0.95	0.95
Percent Heavy Veh, %		2	2	2		2	2	2	2	2	2	2
Cap, veh/h		289	2015			120	1765		362	619	288	265
Arrive On Green		0.08	0.39	0.00		0.03	0.35	0.00	0.04	0.26	0.26	0.08
Sat Flow, veh/h		3456	5106	1585		3456	5106	1585	1781	2354	1096	3456
Grp Volume(v), veh/h		217	1533	0		44	1293	0	68	69	70	196
Grp Sat Flow(s),veh/h/ln		1728	1702	1585		1728	1702	1585	1781	1777	1673	1728
Q Serve(g_s), s		6.4	27.0	0.0		1.3	23.1	0.0	2.9	3.1	3.4	5.8
Cycle Q Clear(g_c), s		6.4	27.0	0.0		1.3	23.1	0.0	2.9	3.1	3.4	5.8
Prop In Lane		1.00		1.00		1.00		1.00	1.00		0.66	1.00
Lane Grp Cap(c), veh/h		289	2015			120	1765		362	467	440	265
V/C Ratio(X)		0.75	0.76			0.37	0.73		0.19	0.15	0.16	0.74
Avail Cap(c_a), veh/h		466	2703			166	2261		374	467	440	399
HCM Platoon Ratio		1.00	1.00	1.00		1.00	1.00	1.00	1.00	1.00	1.00	1.00
Upstream Filter(l)		1.00	1.00	0.00		1.00	1.00	0.00	1.00	1.00	1.00	1.00
Uniform Delay (d), s/veh		46.5	27.2	0.0		49.0	29.8	0.0	26.1	29.3	29.4	46.9
Incr Delay (d2), s/veh		3.9	0.9	0.0		1.9	0.9	0.0	0.2	0.7	0.8	4.0
Initial Q Delay(d3),s/veh		0.0	0.0	0.0		0.0	0.0	0.0	0.0	0.0	0.0	0.0
%ile BackOfQ(50%),veh/ln		2.8	10.3	0.0		0.6	9.0	0.0	1.2	1.4	1.4	2.6
Unsig. Movement Delay, s/veh												
LnGrp Delay(d),s/veh		50.5	28.1	0.0		50.9	30.7	0.0	26.4	30.0	30.2	51.0
LnGrp LOS		D	C			D	C		C	C	C	D
Approach Vol, veh/h			1750	A			1337	A		207		
Approach Delay, s/veh			30.9				31.4			28.9		
Approach LOS			C				C			C		
Timer - Assigned Phs	1	2	3	4	5	6	7	8				
Phs Duration (G+Y+Rc), s	14.7	41.9	10.3	37.0	9.6	47.0	14.0	33.3				
Change Period (Y+Rc), s	6.0	6.0	6.0	6.0	6.0	6.0	6.0	6.0				
Max Green Setting (Gmax), s	14.0	46.0	5.0	31.0	5.0	55.0	12.0	24.0				
Max Q Clear Time (g_c+I1), s	8.4	25.1	4.9	22.5	3.3	29.0	7.8	5.4				
Green Ext Time (p_c), s	0.3	8.8	0.0	1.7	0.0	12.0	0.2	0.6				

Intersection Summary

HCM 6th Ctrl Delay	32.7
HCM 6th LOS	C

Notes

User approved ignoring U-Turning movement.
Unsignalized Delay for [EBR, WBR] is excluded from calculations of the approach delay and intersection delay.

HCM 6th Signalized Intersection Summary
 5: Rays Rd & Memorial Dr

Spivey Lake Residential
 No Build PM



Movement	SBT	SBR
Lane Configurations	↑↑	↑
Traffic Volume (veh/h)	193	331
Future Volume (veh/h)	193	331
Initial Q (Qb), veh	0	0
Ped-Bike Adj(A_pbT)		1.00
Parking Bus, Adj	1.00	1.00
Work Zone On Approach	No	
Adj Sat Flow, veh/h/ln	1870	1870
Adj Flow Rate, veh/h	203	348
Peak Hour Factor	0.95	0.95
Percent Heavy Veh, %	2	2
Cap, veh/h	1060	473
Arrive On Green	0.30	0.30
Sat Flow, veh/h	3554	1585
Grp Volume(v), veh/h	203	348
Grp Sat Flow(s),veh/h/ln	1777	1585
Q Serve(g_s), s	4.4	20.5
Cycle Q Clear(g_c), s	4.4	20.5
Prop In Lane		1.00
Lane Grp Cap(c), veh/h	1060	473
V/C Ratio(X)	0.19	0.74
Avail Cap(c_a), veh/h	1060	473
HCM Platoon Ratio	1.00	1.00
Upstream Filter(l)	1.00	1.00
Uniform Delay (d), s/veh	27.1	32.8
Incr Delay (d2), s/veh	0.4	9.8
Initial Q Delay(d3),s/veh	0.0	0.0
%ile BackOfQ(50%),veh/ln	1.9	8.9
Unsig. Movement Delay, s/veh		
LnGrp Delay(d),s/veh	27.5	42.5
LnGrp LOS	C	D
Approach Vol, veh/h	747	
Approach Delay, s/veh	40.7	
Approach LOS	D	
Timer - Assigned Phs		

Intersection												
Int Delay, s/veh	4.6											
Movement	EBL	EBT	EBR	WBL	WBT	WBR	NBL	NBT	NBR	SBL	SBT	SBR
Lane Configurations		↕			↕			↕			↕	
Traffic Vol, veh/h	30	61	2	1	102	27	7	0	5	34	0	81
Future Vol, veh/h	30	61	2	1	102	27	7	0	5	34	0	81
Conflicting Peds, #/hr	0	0	0	0	0	0	0	0	0	0	0	0
Sign Control	Free	Free	Free	Free	Free	Free	Stop	Stop	Stop	Stop	Stop	Stop
RT Channelized	-	-	None	-	-	None	-	-	None	-	-	None
Storage Length	-	-	-	-	-	-	-	-	-	-	-	-
Veh in Median Storage, #	-	0	-	-	0	-	-	0	-	-	0	-
Grade, %	-	0	-	-	0	-	-	0	-	-	0	-
Peak Hour Factor	79	79	79	79	79	79	79	79	79	79	79	79
Heavy Vehicles, %	2	9	2	2	12	6	2	2	2	23	2	14
Mvmt Flow	38	77	3	1	129	34	9	0	6	43	0	103

Major/Minor	Major1			Major2			Minor1			Minor2		
Conflicting Flow All	163	0	0	80	0	0	355	320	79	306	304	146
Stage 1	-	-	-	-	-	-	155	155	-	148	148	-
Stage 2	-	-	-	-	-	-	200	165	-	158	156	-
Critical Hdwy	4.12	-	-	4.12	-	-	7.12	6.52	6.22	7.33	6.52	6.34
Critical Hdwy Stg 1	-	-	-	-	-	-	6.12	5.52	-	6.33	5.52	-
Critical Hdwy Stg 2	-	-	-	-	-	-	6.12	5.52	-	6.33	5.52	-
Follow-up Hdwy	2.218	-	-	2.218	-	-	3.518	4.018	3.318	3.707	4.018	3.426
Pot Cap-1 Maneuver	1416	-	-	1518	-	-	600	597	981	607	609	870
Stage 1	-	-	-	-	-	-	847	769	-	807	775	-
Stage 2	-	-	-	-	-	-	802	762	-	797	769	-
Platoon blocked, %	-	-	-	-	-	-	-	-	-	-	-	-
Mov Cap-1 Maneuver	1416	-	-	1518	-	-	518	580	981	590	591	870
Mov Cap-2 Maneuver	-	-	-	-	-	-	518	580	-	590	591	-
Stage 1	-	-	-	-	-	-	823	747	-	784	774	-
Stage 2	-	-	-	-	-	-	707	761	-	770	747	-

Approach	EB			WB			NB			SB		
HCM Control Delay, s	2.5			0.1			10.7			10.8		
HCM LOS							B			B		

Minor Lane/Major Mvmt	NBLn1	EBL	EBT	EBR	WBL	WBT	WBR	SBLn1
Capacity (veh/h)	645	1416	-	-	1518	-	-	763
HCM Lane V/C Ratio	0.024	0.027	-	-	0.001	-	-	0.191
HCM Control Delay (s)	10.7	7.6	0	-	7.4	0	-	10.8
HCM Lane LOS	B	A	A	-	A	A	-	B
HCM 95th %tile Q(veh)	0.1	0.1	-	-	0	-	-	0.7

Intersection						
Int Delay, s/veh	1.7					
Movement	EBT	EBR	WBL	WBT	NBL	NBR
Lane Configurations						
Traffic Vol, veh/h	96	7	5	109	24	17
Future Vol, veh/h	96	7	5	109	24	17
Conflicting Peds, #/hr	0	0	0	0	0	0
Sign Control	Free	Free	Free	Free	Stop	Stop
RT Channelized	-	None	-	None	-	None
Storage Length	-	-	-	-	0	-
Veh in Median Storage, #	0	-	-	0	0	-
Grade, %	0	-	-	0	0	-
Peak Hour Factor	92	92	92	92	92	92
Heavy Vehicles, %	2	2	2	2	2	2
Mvmt Flow	104	8	5	118	26	18

Major/Minor	Major1	Major2	Minor1		
Conflicting Flow All	0	0	112	0	236 108
Stage 1	-	-	-	-	108 -
Stage 2	-	-	-	-	128 -
Critical Hdwy	-	-	4.12	-	6.42 6.22
Critical Hdwy Stg 1	-	-	-	-	5.42 -
Critical Hdwy Stg 2	-	-	-	-	5.42 -
Follow-up Hdwy	-	-	2.218	-	3.518 3.318
Pot Cap-1 Maneuver	-	-	1478	-	752 946
Stage 1	-	-	-	-	916 -
Stage 2	-	-	-	-	898 -
Platoon blocked, %	-	-	-	-	-
Mov Cap-1 Maneuver	-	-	1478	-	749 946
Mov Cap-2 Maneuver	-	-	-	-	749 -
Stage 1	-	-	-	-	916 -
Stage 2	-	-	-	-	894 -

Approach	EB	WB	NB
HCM Control Delay, s	0	0.3	9.6
HCM LOS			A

Minor Lane/Major Mvmt	NBLn1	EBT	EBR	WBL	WBT
Capacity (veh/h)	820	-	-	1478	-
HCM Lane V/C Ratio	0.054	-	-	0.004	-
HCM Control Delay (s)	9.6	-	-	7.4	0
HCM Lane LOS	A	-	-	A	A
HCM 95th %tile Q(veh)	0.2	-	-	0	-

Intersection						
Int Delay, s/veh	2.4					
Movement	EBL	EBR	NBL	NBT	SBT	SBR
Lane Configurations	T		T		T	
Traffic Vol, veh/h	22	67	79	261	380	32
Future Vol, veh/h	22	67	79	261	380	32
Conflicting Peds, #/hr	0	0	0	0	0	0
Sign Control	Stop	Stop	Free	Free	Free	Free
RT Channelized	-	None	-	None	-	None
Storage Length	0	-	-	-	-	-
Veh in Median Storage, #	0	-	-	0	0	-
Grade, %	0	-	-	0	0	-
Peak Hour Factor	88	88	88	88	88	88
Heavy Vehicles, %	2	3	2	6	8	2
Mvmt Flow	25	76	90	297	432	36

Major/Minor	Minor2	Major1		Major2	
Conflicting Flow All	927	450	468	0	0
Stage 1	450	-	-	-	-
Stage 2	477	-	-	-	-
Critical Hdwy	6.42	6.23	4.12	-	-
Critical Hdwy Stg 1	5.42	-	-	-	-
Critical Hdwy Stg 2	5.42	-	-	-	-
Follow-up Hdwy	3.518	3.327	2.218	-	-
Pot Cap-1 Maneuver	298	607	1094	-	-
Stage 1	642	-	-	-	-
Stage 2	624	-	-	-	-
Platoon blocked, %				-	-
Mov Cap-1 Maneuver	269	607	1094	-	-
Mov Cap-2 Maneuver	269	-	-	-	-
Stage 1	579	-	-	-	-
Stage 2	624	-	-	-	-

Approach	EB	NB	SB
HCM Control Delay, s	14.9	2	0
HCM LOS	B		

Minor Lane/Major Mvmt	NBL	NBT	EBLn1	SBT	SBR
Capacity (veh/h)	1094	-	463	-	-
HCM Lane V/C Ratio	0.082	-	0.218	-	-
HCM Control Delay (s)	8.6	0	14.9	-	-
HCM Lane LOS	A	A	B	-	-
HCM 95th %tile Q(veh)	0.3	-	0.8	-	-

Intersection						
Int Delay, s/veh	0.9					
Movement	EBL	EBR	NBL	NBT	SBT	SBR
Lane Configurations	T			T		
Traffic Vol, veh/h	15	33	10	307	457	5
Future Vol, veh/h	15	33	10	307	457	5
Conflicting Peds, #/hr	0	0	0	0	0	0
Sign Control	Stop	Stop	Free	Free	Free	Free
RT Channelized	-	None	-	None	-	None
Storage Length	0	-	-	-	-	-
Veh in Median Storage, #	0	-	-	0	0	-
Grade, %	0	-	-	0	0	-
Peak Hour Factor	90	90	90	90	90	90
Heavy Vehicles, %	2	2	2	6	7	2
Mvmt Flow	17	37	11	341	508	6

Major/Minor	Minor2	Major1	Major2			
Conflicting Flow All	874	511	514	0	-	0
Stage 1	511	-	-	-	-	-
Stage 2	363	-	-	-	-	-
Critical Hdwy	6.42	6.22	4.12	-	-	-
Critical Hdwy Stg 1	5.42	-	-	-	-	-
Critical Hdwy Stg 2	5.42	-	-	-	-	-
Follow-up Hdwy	3.518	3.318	2.218	-	-	-
Pot Cap-1 Maneuver	320	563	1052	-	-	-
Stage 1	602	-	-	-	-	-
Stage 2	704	-	-	-	-	-
Platoon blocked, %				-	-	-
Mov Cap-1 Maneuver	316	563	1052	-	-	-
Mov Cap-2 Maneuver	316	-	-	-	-	-
Stage 1	594	-	-	-	-	-
Stage 2	704	-	-	-	-	-

Approach	EB	NB	SB
HCM Control Delay, s	14	0.3	0
HCM LOS	B		

Minor Lane/Major Mvmt	NBL	NBT	EBLn1	SBT	SBR
Capacity (veh/h)	1052	-	452	-	-
HCM Lane V/C Ratio	0.011	-	0.118	-	-
HCM Control Delay (s)	8.5	0	14	-	-
HCM Lane LOS	A	A	B	-	-
HCM 95th %tile Q(veh)	0	-	0.4	-	-

HCM 6th Signalized Intersection Summary
5: Rays Rd & Memorial Dr

Spivey Lake Residential
Build AM

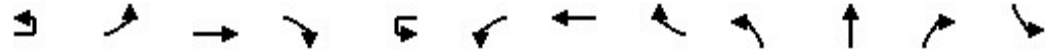

Movement	EBU	EBL	EBT	EBR	WBU	WBL	WBT	WBR	NBL	NBT	NBR	SBL
Lane Configurations		2T	3T	T		2T	3T	T	T	2T		2T
Traffic Volume (veh/h)	9	121	809	46	15	15	1311	94	55	108	20	87
Future Volume (veh/h)	9	121	809	46	15	15	1311	94	55	108	20	87
Initial Q (Qb), veh		0	0	0		0	0	0	0	0	0	0
Ped-Bike Adj(A_pbT)		1.00		1.00		1.00		1.00	1.00		1.00	1.00
Parking Bus, Adj		1.00	1.00	1.00		1.00	1.00	1.00	1.00	1.00	1.00	1.00
Work Zone On Approach			No				No			No		
Adj Sat Flow, veh/h/ln		1752	1796	1856		1752	1826	1796	1870	1870	1870	1737
Adj Flow Rate, veh/h		125	834	0		15	1352	0	57	111	21	90
Peak Hour Factor		0.97	0.97	0.97		0.97	0.97	0.97	0.97	0.97	0.97	0.97
Percent Heavy Veh, %		10	7	3		10	5	7	2	2	2	11
Cap, veh/h		183	1924			55	1759		448	939	173	144
Arrive On Green		0.06	0.39	0.00		0.02	0.35	0.00	0.04	0.31	0.31	0.04
Sat Flow, veh/h		3237	4904	1572		3237	4985	1522	1781	2994	553	3209
Grp Volume(v), veh/h		125	834	0		15	1352	0	57	65	67	90
Grp Sat Flow(s),veh/h/ln		1618	1635	1572		1618	1662	1522	1781	1777	1771	1605
Q Serve(g_s), s		3.9	12.9	0.0		0.5	24.9	0.0	2.2	2.7	2.8	2.8
Cycle Q Clear(g_c), s		3.9	12.9	0.0		0.5	24.9	0.0	2.2	2.7	2.8	2.8
Prop In Lane		1.00		1.00		1.00		1.00	1.00		0.31	1.00
Lane Grp Cap(c), veh/h		183	1924			55	1759		448	557	555	144
V/C Ratio(X)		0.68	0.43			0.27	0.77		0.13	0.12	0.12	0.63
Avail Cap(c_a), veh/h		282	2516			157	2364		465	557	555	217
HCM Platoon Ratio		1.00	1.00	1.00		1.00	1.00	1.00	1.00	1.00	1.00	1.00
Upstream Filter(l)		1.00	1.00	0.00		1.00	1.00	0.00	1.00	1.00	1.00	1.00
Uniform Delay (d), s/veh		47.8	23.0	0.0		50.2	29.7	0.0	22.4	25.3	25.3	48.5
Incr Delay (d2), s/veh		4.5	0.2	0.0		2.7	1.1	0.0	0.1	0.4	0.4	4.4
Initial Q Delay(d3),s/veh		0.0	0.0	0.0		0.0	0.0	0.0	0.0	0.0	0.0	0.0
%ile BackOfQ(50%),veh/ln		1.6	4.7	0.0		0.2	9.5	0.0	0.9	1.2	1.2	1.2
Unsig. Movement Delay, s/veh												
LnGrp Delay(d),s/veh		52.3	23.1	0.0		52.8	30.8	0.0	22.5	25.7	25.7	52.9
LnGrp LOS		D	C			D	C		C	C	C	D
Approach Vol, veh/h			959	A			1367	A		189		
Approach Delay, s/veh			26.9				31.0			24.7		
Approach LOS			C				C			C		
Timer - Assigned Phs	1	2	3	4	5	6	7	8				
Phs Duration (G+Y+Rc), s	11.8	42.5	10.0	39.0	7.7	46.5	10.6	38.4				
Change Period (Y+Rc), s	6.0	6.0	6.0	6.0	6.0	6.0	6.0	6.0				
Max Green Setting (Gmax), s	9.0	49.0	5.0	33.0	5.0	53.0	7.0	31.0				
Max Q Clear Time (g_c+I1), s	5.9	26.9	4.2	19.9	2.5	14.9	4.8	4.8				
Green Ext Time (p_c), s	0.1	9.6	0.0	1.2	0.0	6.1	0.0	0.7				

Intersection Summary

HCM 6th Ctrl Delay	30.4
HCM 6th LOS	C

Notes

User approved ignoring U-Turning movement.
Unsignalized Delay for [EBR, WBR] is excluded from calculations of the approach delay and intersection delay.

HCM 6th Signalized Intersection Summary
 5: Rays Rd & Memorial Dr

Spivey Lake Residential
 Build AM



Movement	SBT	SBR
Lane Configurations	↑↑	↑
Traffic Volume (veh/h)	64	300
Future Volume (veh/h)	64	300
Initial Q (Qb), veh	0	0
Ped-Bike Adj(A_pbT)		1.00
Parking Bus, Adj	1.00	1.00
Work Zone On Approach	No	
Adj Sat Flow, veh/h/ln	1870	1796
Adj Flow Rate, veh/h	66	309
Peak Hour Factor	0.97	0.97
Percent Heavy Veh, %	2	7
Cap, veh/h	1135	486
Arrive On Green	0.32	0.32
Sat Flow, veh/h	3554	1522
Grp Volume(v), veh/h	66	309
Grp Sat Flow(s),veh/h/ln	1777	1522
Q Serve(g_s), s	1.3	17.9
Cycle Q Clear(g_c), s	1.3	17.9
Prop In Lane		1.00
Lane Grp Cap(c), veh/h	1135	486
V/C Ratio(X)	0.06	0.64
Avail Cap(c_a), veh/h	1135	486
HCM Platoon Ratio	1.00	1.00
Upstream Filter(l)	1.00	1.00
Uniform Delay (d), s/veh	24.4	30.0
Incr Delay (d2), s/veh	0.1	6.2
Initial Q Delay(d3),s/veh	0.0	0.0
%ile BackOfQ(50%),veh/ln	0.6	7.2
Unsig. Movement Delay, s/veh		
LnGrp Delay(d),s/veh	24.5	36.2
LnGrp LOS	C	D
Approach Vol, veh/h	465	
Approach Delay, s/veh	37.8	
Approach LOS	D	
Timer - Assigned Phs		

Intersection												
Int Delay, s/veh	1.5											
Movement	EBL	EBT	EBR	WBL	WBT	WBR	NBL	NBT	NBR	SBL	SBT	SBR
Lane Configurations		↕			↕			↕			↕	
Traffic Vol, veh/h	14	171	7	4	88	9	4	1	3	13	1	13
Future Vol, veh/h	14	171	7	4	88	9	4	1	3	13	1	13
Conflicting Peds, #/hr	0	0	0	0	0	0	0	0	0	0	0	0
Sign Control	Free	Free	Free	Free	Free	Free	Stop	Stop	Stop	Stop	Stop	Stop
RT Channelized	-	-	None	-	-	None	-	-	None	-	-	None
Storage Length	-	-	-	-	-	-	-	-	-	-	-	-
Veh in Median Storage, #	-	0	-	-	0	-	-	0	-	-	0	-
Grade, %	-	0	-	-	0	-	-	0	-	-	0	-
Peak Hour Factor	91	91	91	91	91	91	91	91	91	91	91	91
Heavy Vehicles, %	8	2	2	2	3	2	2	2	2	2	2	2
Mvmt Flow	15	188	8	4	97	10	4	1	3	14	1	14

Major/Minor	Major1		Major2		Minor1		Minor2					
Conflicting Flow All	107	0	0	196	0	0	340	337	192	334	336	102
Stage 1	-	-	-	-	-	-	222	222	-	110	110	-
Stage 2	-	-	-	-	-	-	118	115	-	224	226	-
Critical Hdwy	4.18	-	-	4.12	-	-	7.12	6.52	6.22	7.12	6.52	6.22
Critical Hdwy Stg 1	-	-	-	-	-	-	6.12	5.52	-	6.12	5.52	-
Critical Hdwy Stg 2	-	-	-	-	-	-	6.12	5.52	-	6.12	5.52	-
Follow-up Hdwy	2.272	-	-	2.218	-	-	3.518	4.018	3.318	3.518	4.018	3.318
Pot Cap-1 Maneuver	1447	-	-	1377	-	-	614	584	850	620	585	953
Stage 1	-	-	-	-	-	-	780	720	-	895	804	-
Stage 2	-	-	-	-	-	-	887	800	-	779	717	-
Platoon blocked, %		-	-		-	-						
Mov Cap-1 Maneuver	1447	-	-	1377	-	-	597	575	850	609	576	953
Mov Cap-2 Maneuver	-	-	-	-	-	-	597	575	-	609	576	-
Stage 1	-	-	-	-	-	-	771	711	-	884	802	-
Stage 2	-	-	-	-	-	-	870	798	-	765	708	-

Approach	EB		WB		NB		SB	
HCM Control Delay, s	0.5		0.3		10.5		10.1	
HCM LOS					B		B	

Minor Lane/Major Mvmt	NBLn1	EBL	EBT	EBR	WBL	WBT	WBR	SBLn1
Capacity (veh/h)	668	1447	-	-	1377	-	-	735
HCM Lane V/C Ratio	0.013	0.011	-	-	0.003	-	-	0.04
HCM Control Delay (s)	10.5	7.5	0	-	7.6	0	-	10.1
HCM Lane LOS	B	A	A	-	A	A	-	B
HCM 95th %tile Q(veh)	0	0	-	-	0	-	-	0.1

Intersection						
Int Delay, s/veh	1.1					
Movement	EBT	EBR	WBL	WBT	NBL	NBR
Lane Configurations						
Traffic Vol, veh/h	168	24	17	97	14	10
Future Vol, veh/h	168	24	17	97	14	10
Conflicting Peds, #/hr	0	0	0	0	0	0
Sign Control	Free	Free	Free	Free	Stop	Stop
RT Channelized	-	None	-	None	-	None
Storage Length	-	-	-	-	0	-
Veh in Median Storage, #	0	-	-	0	0	-
Grade, %	0	-	-	0	0	-
Peak Hour Factor	92	92	92	92	92	92
Heavy Vehicles, %	2	2	2	2	2	2
Mvmt Flow	183	26	18	105	15	11

Major/Minor	Major1	Major2	Minor1		
Conflicting Flow All	0	0	209	0	337
Stage 1	-	-	-	-	196
Stage 2	-	-	-	-	141
Critical Hdwy	-	-	4.12	-	6.42
Critical Hdwy Stg 1	-	-	-	-	5.42
Critical Hdwy Stg 2	-	-	-	-	5.42
Follow-up Hdwy	-	-	2.218	-	3.518
Pot Cap-1 Maneuver	-	-	1362	-	658
Stage 1	-	-	-	-	837
Stage 2	-	-	-	-	886
Platoon blocked, %	-	-	-	-	-
Mov Cap-1 Maneuver	-	-	1362	-	649
Mov Cap-2 Maneuver	-	-	-	-	649
Stage 1	-	-	-	-	837
Stage 2	-	-	-	-	874

Approach	EB	WB	NB
HCM Control Delay, s	0	1.1	10.2
HCM LOS			B

Minor Lane/Major Mvmt	NBLn1	EBT	EBR	WBL	WBT
Capacity (veh/h)	718	-	-	1362	-
HCM Lane V/C Ratio	0.036	-	-	0.014	-
HCM Control Delay (s)	10.2	-	-	7.7	0
HCM Lane LOS	B	-	-	A	A
HCM 95th %tile Q(veh)	0.1	-	-	0	-

Intersection						
Int Delay, s/veh	4.5					
Movement	EBL	EBR	NBL	NBT	SBT	SBR
Lane Configurations	T			T		
Traffic Vol, veh/h	39	133	82	347	570	29
Future Vol, veh/h	39	133	82	347	570	29
Conflicting Peds, #/hr	0	0	0	0	0	0
Sign Control	Stop	Stop	Free	Free	Free	Free
RT Channelized	-	None	-	None	-	None
Storage Length	0	-	-	-	-	-
Veh in Median Storage, #	0	-	-	0	0	-
Grade, %	0	-	-	0	0	-
Peak Hour Factor	92	92	92	92	92	92
Heavy Vehicles, %	2	2	2	2	2	5
Mvmt Flow	42	145	89	377	620	32

Major/Minor	Minor2	Major1	Major2			
Conflicting Flow All	1191	636	652	0	-	0
Stage 1	636	-	-	-	-	-
Stage 2	555	-	-	-	-	-
Critical Hdwy	6.42	6.22	4.12	-	-	-
Critical Hdwy Stg 1	5.42	-	-	-	-	-
Critical Hdwy Stg 2	5.42	-	-	-	-	-
Follow-up Hdwy	3.518	3.318	2.218	-	-	-
Pot Cap-1 Maneuver	207	478	935	-	-	-
Stage 1	527	-	-	-	-	-
Stage 2	575	-	-	-	-	-
Platoon blocked, %				-	-	-
Mov Cap-1 Maneuver	182	478	935	-	-	-
Mov Cap-2 Maneuver	182	-	-	-	-	-
Stage 1	464	-	-	-	-	-
Stage 2	575	-	-	-	-	-

Approach	EB	NB	SB
HCM Control Delay, s	26.6	1.8	0
HCM LOS	D		

Minor Lane/Major Mvmt	NBL	NBT	EBLn1	SBT	SBR
Capacity (veh/h)	935	-	349	-	-
HCM Lane V/C Ratio	0.095	-	0.536	-	-
HCM Control Delay (s)	9.3	0	26.6	-	-
HCM Lane LOS	A	A	D	-	-
HCM 95th %tile Q(veh)	0.3	-	3	-	-

Intersection						
Int Delay, s/veh	1					
Movement	EBL	EBR	NBL	NBT	SBT	SBR
Lane Configurations	T			T		T
Traffic Vol, veh/h	10	27	41	413	684	14
Future Vol, veh/h	10	27	41	413	684	14
Conflicting Peds, #/hr	0	0	0	0	0	0
Sign Control	Stop	Stop	Free	Free	Free	Free
RT Channelized	-	None	-	None	-	None
Storage Length	0	-	-	-	-	-
Veh in Median Storage, #	0	-	-	0	0	-
Grade, %	0	-	-	0	0	-
Peak Hour Factor	89	89	89	89	89	89
Heavy Vehicles, %	2	2	2	2	2	2
Mvmt Flow	11	30	46	464	769	16

Major/Minor	Minor2	Major1	Major2			
Conflicting Flow All	1333	777	785	0	-	0
Stage 1	777	-	-	-	-	-
Stage 2	556	-	-	-	-	-
Critical Hdwy	6.42	6.22	4.12	-	-	-
Critical Hdwy Stg 1	5.42	-	-	-	-	-
Critical Hdwy Stg 2	5.42	-	-	-	-	-
Follow-up Hdwy	3.518	3.318	2.218	-	-	-
Pot Cap-1 Maneuver	170	397	834	-	-	-
Stage 1	453	-	-	-	-	-
Stage 2	574	-	-	-	-	-
Platoon blocked, %				-	-	-
Mov Cap-1 Maneuver	157	397	834	-	-	-
Mov Cap-2 Maneuver	157	-	-	-	-	-
Stage 1	419	-	-	-	-	-
Stage 2	574	-	-	-	-	-

Approach	EB	NB	SB
HCM Control Delay, s	20	0.9	0
HCM LOS	C		

Minor Lane/Major Mvmt	NBL	NBT	EBLn1	SBT	SBR
Capacity (veh/h)	834	-	281	-	-
HCM Lane V/C Ratio	0.055	-	0.148	-	-
HCM Control Delay (s)	9.6	0	20	-	-
HCM Lane LOS	A	A	C	-	-
HCM 95th %tile Q(veh)	0.2	-	0.5	-	-

HCM 6th Signalized Intersection Summary
5: Rays Rd & Memorial Dr

Spivey Lake Residential
Build PM

Movement	EBU	EBL	EBT	EBR	WBU	WBL	WBT	WBR	NBL	NBT	NBR	SBL
Lane Configurations		LT	LT	LT		LT	LT	LT	LT	LT	LT	LT
Traffic Volume (veh/h)	10	227	1456	77	15	42	1228	154	65	97	44	194
Future Volume (veh/h)	10	227	1456	77	15	42	1228	154	65	97	44	194
Initial Q (Qb), veh		0	0	0		0	0	0	0	0	0	0
Ped-Bike Adj(A_pbT)		1.00		1.00		1.00		1.00	1.00		1.00	1.00
Parking Bus, Adj		1.00	1.00	1.00		1.00	1.00	1.00	1.00	1.00	1.00	1.00
Work Zone On Approach			No				No			No		
Adj Sat Flow, veh/h/ln		1870	1870	1870		1870	1870	1870	1870	1870	1870	1870
Adj Flow Rate, veh/h		239	1533	0		44	1293	0	68	102	46	204
Peak Hour Factor		0.95	0.95	0.95		0.95	0.95	0.95	0.95	0.95	0.95	0.95
Percent Heavy Veh, %		2	2	2		2	2	2	2	2	2	2
Cap, veh/h		309	1981			118	1699		366	662	283	272
Arrive On Green		0.09	0.39	0.00		0.03	0.33	0.00	0.04	0.27	0.27	0.08
Sat Flow, veh/h		3456	5106	1585		3456	5106	1585	1781	2425	1036	3456
Grp Volume(v), veh/h		239	1533	0		44	1293	0	68	73	75	204
Grp Sat Flow(s),veh/h/ln		1728	1702	1585		1728	1702	1585	1781	1777	1684	1728
Q Serve(g_s), s		7.2	27.9	0.0		1.3	24.0	0.0	2.9	3.3	3.6	6.1
Cycle Q Clear(g_c), s		7.2	27.9	0.0		1.3	24.0	0.0	2.9	3.3	3.6	6.1
Prop In Lane		1.00		1.00		1.00		1.00	1.00		0.62	1.00
Lane Grp Cap(c), veh/h		309	1981			118	1699		366	485	460	272
V/C Ratio(X)		0.77	0.77			0.37	0.76		0.19	0.15	0.16	0.75
Avail Cap(c_a), veh/h		456	2549			163	2116		377	485	460	391
HCM Platoon Ratio		1.00	1.00	1.00		1.00	1.00	1.00	1.00	1.00	1.00	1.00
Upstream Filter(l)		1.00	1.00	0.00		1.00	1.00	0.00	1.00	1.00	1.00	1.00
Uniform Delay (d), s/veh		47.3	28.4	0.0		50.1	31.6	0.0	26.0	29.3	29.4	47.9
Incr Delay (d2), s/veh		4.8	1.2	0.0		1.9	1.3	0.0	0.2	0.7	0.8	4.8
Initial Q Delay(d3),s/veh		0.0	0.0	0.0		0.0	0.0	0.0	0.0	0.0	0.0	0.0
%ile BackOfQ(50%),veh/ln		3.2	10.8	0.0		0.6	9.5	0.0	1.2	1.5	1.5	2.8
Unsig. Movement Delay, s/veh												
LnGrp Delay(d),s/veh		52.1	29.6	0.0		52.1	32.9	0.0	26.2	29.9	30.1	52.7
LnGrp LOS		D	C			D	C		C	C	C	D
Approach Vol, veh/h			1772	A			1337	A		216		
Approach Delay, s/veh			32.6				33.6			28.8		
Approach LOS			C				C			C		
Timer - Assigned Phs	1	2	3	4	5	6	7	8				
Phs Duration (G+Y+Rc), s	15.5	41.3	10.3	39.0	9.6	47.2	14.3	35.0				
Change Period (Y+Rc), s	6.0	6.0	6.0	6.0	6.0	6.0	6.0	6.0				
Max Green Setting (Gmax), s	14.0	44.0	5.0	33.0	5.0	53.0	12.0	26.0				
Max Q Clear Time (g_c+I1), s	9.2	26.0	4.9	23.7	3.3	29.9	8.1	5.6				
Green Ext Time (p_c), s	0.3	8.2	0.0	1.8	0.0	11.3	0.2	0.7				

Intersection Summary

HCM 6th Ctrl Delay	34.3
HCM 6th LOS	C

Notes

User approved ignoring U-Turning movement.
Unsignalized Delay for [EBR, WBR] is excluded from calculations of the approach delay and intersection delay.

HCM 6th Signalized Intersection Summary
 5: Rays Rd & Memorial Dr

Spivey Lake Residential
 Build PM



Movement	SBT	SBR
Lane Configurations	↑↑	↑
Traffic Volume (veh/h)	199	344
Future Volume (veh/h)	199	344
Initial Q (Qb), veh	0	0
Ped-Bike Adj(A_pbT)		1.00
Parking Bus, Adj	1.00	1.00
Work Zone On Approach	No	
Adj Sat Flow, veh/h/ln	1870	1870
Adj Flow Rate, veh/h	209	362
Peak Hour Factor	0.95	0.95
Percent Heavy Veh, %	2	2
Cap, veh/h	1105	493
Arrive On Green	0.31	0.31
Sat Flow, veh/h	3554	1585
Grp Volume(v), veh/h	209	362
Grp Sat Flow(s),veh/h/ln	1777	1585
Q Serve(g_s), s	4.6	21.7
Cycle Q Clear(g_c), s	4.6	21.7
Prop In Lane		1.00
Lane Grp Cap(c), veh/h	1105	493
V/C Ratio(X)	0.19	0.73
Avail Cap(c_a), veh/h	1105	493
HCM Platoon Ratio	1.00	1.00
Upstream Filter(l)	1.00	1.00
Uniform Delay (d), s/veh	26.8	32.7
Incr Delay (d2), s/veh	0.4	9.4
Initial Q Delay(d3),s/veh	0.0	0.0
%ile BackOfQ(50%),veh/ln	2.0	9.4
Unsig. Movement Delay, s/veh		
LnGrp Delay(d),s/veh	27.2	42.0
LnGrp LOS	C	D
Approach Vol, veh/h	775	
Approach Delay, s/veh	40.8	
Approach LOS	D	
Timer - Assigned Phs		

APPENDIX D: TURN LANE EVALUATIONS

GDOT Access Manual Turn Lane Evaluations

ID	Intersection	Movement/ Turn Lane	GDOT Criteria met?	AADT (Norman Rd): < 6,000 Trip Dist. Volume			
1	Driveway 1 / Otello Rd & Norman Rd	WBL	NO	LTV	4%	37	> 300
		EBR	NO	RTV	8%	74	> 200
2	Driveway 2 & Norman Rd	WBL	NO	LTV	18%	166	> 300
		EBR	YES	RTV	26%	240	> 200
4	Rays Rd & Spartan Ln	NBL	NO	LTV	31%	286	> 300
		SBR	NO	RTV	13%	120	> 200

		IN	OUT
Daily	1,844	922	922
AM Peak Hour	121	28	93
PM Peak Hour	147	92	55

APPENDIX E: TECHNICAL MEMORANDUM

TECHINCAL MEMO

To: Davis Moore, Mosaic Communities
 From: Naveed Jaffar, PE, PTOE
 Date: April 27, 2021
 Re: Spivey Lake Residential Development, DeKalb County, Georgia

NV5 Engineers & Consultants, Inc. completed a traffic impact study in April 2021 for the proposed Spivey Lake Residential Development along Norman Road in DeKalb County, Georgia. This memorandum serves as a supplement to the completed traffic study in order to provide the hourly distribution of expected generated trips to and from the development. This memorandum also serves to explore the potential trip reduction for multi-modal and transit impacts.

Trip Generation – Hourly Trip Generation

The proposed development will consist of 40 single family homes, 138 two-family homes, and 52 townhomes. The development has a projected build out date of 2024 and will generate a total of 1,844 new daily trips. Of these daily volumes, 121 (28 entering and 93 exiting) are expected to occur in the AM peak hour while 147 (92 entering and 55 exiting) are expected to occur in the PM peak hour. Table 1 depicts the total expected Trip Generation for the development.

Table 1. Complete Trip Generation

LAND USE	PERIOD	TOTAL	IN	OUT
Single Family Homes, LUC 210 (40 Dwelling Units)	Daily	448	224	224
	AM Peak Hour	33	8	25
	PM Peak Hour	42	26	16
*Two/Three Family Homes (190 Dwelling Units - 138 Two-Family Homes, 52 Townhomes)	Daily	1,396	698	698
	AM Peak Hour	88	20	68
	PM Peak Hour	105	66	39
Total Net Trips	Daily	1,844	922	922
	AM Peak Hour	121	28	93
	PM Peak Hour	147	92	55

*Study utilizes ITE (Institute of Transportation Engineers) Land Use Code *Multi-Family Housing Low-Rise (LUC 220)*

The hourly trip generation was developed using the ITE (Institute of Transportation Engineers') methodology. From the hourly trip generation, we can expect on average for there to be one (1) vehicle every 0.8 minutes (46 seconds) throughout the day. Table 2 depicts the estimated number of generated trips expected every hour of the day and the frequency.

Table 2. Estimated Hourly Trip Generation – Trip Generation Rate

Beginning Hour	Expected Trips	
	Total	Vehicle Every (X) Minutes
12:00 AM	14	4.2
1:00 AM	8	7.6
2:00 AM	8	7.4
3:00 AM	9	6.5
4:00 AM	15	4.0
5:00 AM	33	1.8
6:00 AM	69	0.9
7:00 AM	118	0.5
8:00 AM	111	0.5
9:00 AM	97	0.6
10:00 AM	82	0.7
11:00 AM	96	0.6
12:00 PM	102	0.6
1:00 PM	94	0.6
2:00 PM	106	0.6
3:00 PM	127	0.5
4:00 PM	139	0.4
5:00 PM	149	0.4
6:00 PM	137	0.4
7:00 PM	110	0.5
8:00 PM	89	0.7
9:00 PM	66	0.9
10:00 PM	37	1.6
11:00 PM	28	2.2
Total	1,844	0.8

Table 3 depicts the expected number of trips that will utilize Norman Road, Rays Road, and Spartan Lane during each hour of the day. The planned traffic calming measures are likely to discourage travel along Othello Avenue. Therefore, there is not a significant amount of traffic from the development expected to utilize Othello Avenue. Supporting worksheets for computations are attached. The hourly breakdown by movement for each of the access points of the development is also attached.

Table 3. Estimated Hourly Roadway Trips

Beginning Hour	Norman Road b/w Othello Ave and Rays Road		Rays Road b/w Norman Road and Spartan Lane		Spartan Lane b/w subject development and Rays Road	
	Eastbound	Westbound	Northbound	Southbound	Eastbound	Westbound
12:00 AM	4	4	5	4	2	4
1:00 AM	2	2	3	2	1	2
2:00 AM	2	2	2	3	2	2
3:00 AM	3	3	3	3	2	2
4:00 AM	4	5	4	6	4	2
5:00 AM	8	10	7	13	11	3
6:00 AM	17	22	13	29	25	5
7:00 AM	29	37	25	47	40	12
8:00 AM	28	34	24	43	36	12
9:00 AM	25	29	25	34	27	15
10:00 AM	22	24	24	27	20	16
11:00 AM	27	27	29	30	22	20
12:00 PM	29	28	31	31	22	23
1:00 PM	26	26	29	29	21	21
2:00 PM	30	29	34	31	21	25
3:00 PM	37	34	43	34	22	34
4:00 PM	41	37	48	36	23	38
5:00 PM	44	40	52	39	25	41
6:00 PM	41	36	48	36	22	38
7:00 PM	32	30	37	31	21	28
8:00 PM	26	24	31	23	14	25
9:00 PM	20	17	24	17	10	19
10:00 PM	11	10	14	9	5	11
11:00 PM	8	7	11	6	3	9
TOTAL	516	516	563	563	406	406

Trip Reduction

NV5 Engineers & Consultants has developed a potential trip reduction factor that could possibly be used to reduce the number of trips generated by the development. The factor considers the area use of transit, transit availability, pedestrian connection to transit facilities and nearby land uses, and site-specific characteristics. From the data and methodology used, a reduction factor of 0.90 was developed. The trip reduction worksheet is attached.

ATTACHMENTS

Access Point 1

2024 Build Traffic Counts - All Vehicles																				
Time (Hr Beg.)	Norman Road					Norman Road					North Access Point 1					Othello Avenue				
	Eastbound					Westbound					Northbound					Southbound				
	U-Turn	Left	Thru	Right	RTOR	U-Turn	Left	Thru	Right	RTOR	U-Turn	Left	Thru	Right	RTOR	U-Turn	Left	Thru	Right	RTOR
12:00 AM			1				0					0		0						
1:00 AM			0				0					0		0						
2:00 AM			0				0					0		0						
3:00 AM			0				0					0		0						
4:00 AM			0				0					1		0						
5:00 AM			1				0					2		1						
6:00 AM			1				0					5		2						
7:00 AM			2				1					7		4						
8:00 AM			2				1					7		3						
9:00 AM			3				1					5		2						
10:00 AM			3				1					4		2						
11:00 AM			4				2					4		2						
12:00 PM			4				2					4		2						
1:00 PM			4				2					4		2						
2:00 PM			5				2					4		2						
3:00 PM			6				3					4		2						
4:00 PM			7				3					4		2						
5:00 PM			7				4					5		2						
6:00 PM			7				3					4		2						
7:00 PM			5				3					4		2						
8:00 PM			5				2					3		1						
9:00 PM			3				2					2		1						
10:00 PM			2				1					1		0						
11:00 PM			2				1					1		0						
TOTAL			74				37					74		37						



Access Point 2

2024 Build Traffic Counts - All Vehicles																				
Time (Hr Beg.)	Norman Road					Norman Road					North Access Point 2					Southbound				
	Eastbound					Westbound					Northbound									
	U-Turn	Left	Thru	Right	RTOR	U-Turn	Left	Thru	Right	RTOR	U-Turn	Left	Thru	Right	RTOR	U-Turn	Left	Thru	Right	RTOR
12:00 AM			0	2			2	0				1		1						
1:00 AM			0	1			1	0				1		1						
2:00 AM			0	1			1	0				1		1						
3:00 AM			0	1			1	0				1		1						
4:00 AM			0	1			1	0				3		2						
5:00 AM			1	2			1	0				7		5						
6:00 AM			2	3			2	0				15		10						
7:00 AM			4	7			5	1				24		16						
8:00 AM			3	7			5	1				22		15						
9:00 AM			2	9			6	1				16		11						
10:00 AM			2	10			7	1				12		8						
11:00 AM			2	12			8	2				13		9						
12:00 PM			2	13			9	2				13		9						
1:00 PM			2	12			8	2				12		9						
2:00 PM			2	15			10	2				13		9						
3:00 PM			2	20			14	3				13		9						
4:00 PM			2	22			16	3				14		9						
5:00 PM			2	24			17	4				15		10						
6:00 PM			2	22			16	3				13		9						
7:00 PM			2	16			11	3				12		8						
8:00 PM			1	15			10	2				9		6						
9:00 PM			1	11			8	2				6		4						
10:00 PM			0	7			5	1				3		2						
11:00 PM			0	5			4	1				2		1						
TOTAL			37	240			166	37				240		166						



Access Point 3

2024 Build Traffic Counts - All Vehicles																				
Time (Hr Beg.)	Spartan Lane					Rays Road					Rays Road									
	Eastbound					Westbound					Northbound					Southbound				
	U-Turn	Left	Thru	Right	RTOR	U-Turn	Left	Thru	Right	RTOR	U-Turn	Left	Thru	Right	RTOR	U-Turn	Left	Thru	Right	RTOR
12:00 AM		1		2								3	1					1	1	
1:00 AM		0		1								1	1					1	1	
2:00 AM		1		1								1	1					1	1	
3:00 AM		1		2								1	1					1	1	
4:00 AM		1		3								2	1					2	1	
5:00 AM		3		8								2	1					4	1	
6:00 AM		8		18								3	2					10	1	
7:00 AM		12		28								8	5					15	4	
8:00 AM		11		26								9	5					14	4	
9:00 AM		8		19								11	6					11	4	
10:00 AM		6		14								11	6					8	5	
11:00 AM		6		15								14	8					8	6	
12:00 PM		7		16								16	9					9	7	
1:00 PM		6		15								15	8					8	6	
2:00 PM		6		15								18	10					8	7	
3:00 PM		6		15								24	13					8	10	
4:00 PM		7		16								27	15					9	11	
5:00 PM		7		18								29	16					10	12	
6:00 PM		7		16								27	15					9	11	
7:00 PM		6		14								20	11					8	8	
8:00 PM		4		10								18	10					6	7	
9:00 PM		3		7								13	7					4	6	
10:00 PM		2		4								8	4					2	3	
11:00 PM		1		2								6	3					1	3	
TOTAL		120		286								286	157					157	120	



Transit and Carpool Evaluation Tool

4069 Norman Road, Stone Mountain, Georgia 30083

Spivey Lake Residential

Date: 4/21/2021

Prepared by: M. Early



Trip Reduction Factor: **0.90**
 Parking Reduction Factor: **N/A**

Transit Summary

Local Fixed-Route Bus; GOOD arrival times; SOMEWHAT CLOSE; ADEQUATE ped access; ALL can use

Transit is Available to **100%**
 of Residents

Influence of Available Transit **90.0%**
 Area Transit Usage **16.4%**
 Area Carpool Usage **9.5%**
 Area Bike/Ped Activity **1.5%**

Source: American Community Survey, 2018

Comments:

MARTA bus route 121 - Memorial Drive/N. Hairston Road (nearest transit to development); walk to closest transit stop, 0.63 - 1.05 miles; Transect Development character rating, T4; Pedestrian Connection, ADEQUATE- lack of sidewalk along Spartan Lane, consistent sidewalk to transit stops; TDM Strategy, IN PLACE - walking trails facilitating access to local roadway network

- Possible TDM Measures**
- Pre-Tax Incentives
 - Guaranteed Ride Home
 - Ride-Share / Carpool
 - Carpool Parking
 - Bike Facilities
 - Lockers
 - Informational Kiosks
 - Transportation Coordinators
 - Shuttle to Transit
 - Other (Specify)

Site Image:



Pedestrian connections are categorized as follows.

Pedestrian Connection	
Site to Transit Stop/Stn	Rating
Complete	Excellent
Partial-Mitigatable	Adequate
Partial-Non-Mitigatable	Poor
Not an Influencing Factor	Non-Relevant
None	No

Explanation of Rating

Excellent. An unbroken/unobstructed sidewalk or formal walking path from the site to the transit stop/station, providing a safe travel route.

Adequate. A broken/obstructed sidewalk or formal walking path from the site to the transit stop/station, which can be mitigated, and traveler movement and safety are minimally impacted

Poor. An unsafe and/or uncomfortable pedestrian travel environment between the site and the transit stop/station that cannot be mitigated.

Non-relevant. Access to transit stop/station from the site is not impacted by the presence, or lack thereof, of a formal pedestrian connection.

Proprietary to NV5, Inc.

TRAFFIC IMPACT STUDY FOR

SPIVEY LAKE RESIDENTIAL DEVELOPMENT

DATE:

April 28, 2021

LOCATION:

DeKalb County, Georgia

PREPARED FOR:

Mosaic Communities

PREPARED BY:

NV5 Engineers and Consultants, Inc.
1255 Canton Street, Suite G
Roswell, GA 30075

EXECUTIVE SUMMARY

A new residential development is proposed for construction along Norman Road in DeKalb County, Georgia. The proposed development will consist of 40 single family homes, 138 two-family homes, and 52 townhomes. The development has a projected build out date of 2024 and will generate a total of 1,844 new daily trips. Of these daily volumes, 121 (28 entering and 93 exiting) are expected to occur in the AM peak hour while 147 (92 entering and 55 exiting) are expected to occur in the PM peak hour.

The development will contain two (2) full access points along Norman Road and one (1) access point as an extension of Spartan Lane.

Existing intersections adjacent to the planned development were evaluated to determine if new roadway geometries or traffic controls will be needed once the development is built.

The following intersections were evaluated in this study:

1. Otello Avenue/Driveway 1 & Norman Road
2. Driveway 2 & Norman Road
3. Norman Road & Rays Road
4. Spartan Lane & Rays Road
5. Rays Road & Memorial Drive

The analysis uses adjustment factors applied to existing traffic counts as a baseline condition to account for the decrease in traffic due to the COVID-19 pandemic. Under baseline conditions, all intersections operate at a level of service (LOS) "D" or better at each approach.

No-Build conditions for this study show that the assumed 3.4% growth rate does not have a significant effect on the study network. With the increased growth, the intersections do increase in delay (as expected) and only two approaches increase in overall LOS compared to baseline conditions. All intersections continue to operate satisfactorily at an overall LOS D or better.

The additional project trips from the Spivey Lake Residential Development do not significantly affect the study network. With the added trips, the intersections do increase in delay (as expected), but do not change the overall levels of service experienced in the No-Build conditions.

Based on GDOT criteria, the eastern site driveway (Driveway 2) for the development warrants a right-turn deceleration lane. However, the installation of the turn lane is at the discretion of DeKalb County.

Based on the analysis prepared for the proposed development, improvements at the study intersections are not required to mitigate the impact of the proposed development.

TABLE OF CONTENTS

A.	Introduction.....	1
B.	Existing Conditions	4
B.1.	Transportation Facilities	4
B.2.	Traffic Counts	4
B.3.	Baseline Adjustment	6
C.	Future Conditions	8
C.1.	Background Data Collection	8
C.2.	Project Trip Generation	8
C.3.	Trip Distribution and Assignment.....	10
D.	Traffic Impact Analyses	14
D.1.	2021 Existing Capacity Analysis.....	14
D.2.	2021 Baseline Capacity Analysis.....	15
D.3.	2024 No-Build Capacity Analysis	16
D.4.	2024 Build Conditions Capacity Analysis	17
E.	GDOT Turn Lane Evaluations	18
F.	Conclusions.....	19

Appendix

LIST OF TABLES

Table 1:	Project Trip Generation	8
Table 2:	2021 Existing Capacity Analysis.....	14
Table 3:	2021 Baseline Capacity Analysis	15
Table 4:	2024 No-Build Capacity Analysis	16
Table 5:	2024 Build Capacity Analysis	17
Table 6:	GDOT Turn Lane Evaluations.....	18

LIST OF FIGURES

Figure 1.	Vicinity Map	2
Figure 2.	Site Location Aerial	3
Figure 3:	Existing Volumes (2021).....	5
Figure 4:	Baseline Volumes (2021).....	7
Figure 5:	2024 No-Build Traffic Volumes	9
Figure 6:	Trip Distribution	11
Figure 7:	Project Development Trips	12
Figure 8:	2024 Build Traffic Volumes.....	13

A. Introduction

A new residential development is proposed for construction along Norman Road in DeKalb County, Georgia. The proposed development will consist of 40 single family homes, 138 two-family homes, and 52 townhomes.

This traffic study analyzes the impact of new traffic added to the local roadways upon the occupancy of the residential development.

This study includes analysis of the Existing and Baseline Conditions, No-Build Conditions (including background growth and expected traffic from adjacent/nearby developments), and Build Conditions at the following intersections:

1. Otello Avenue/ Driveway 1 & Norman Road
2. Driveway 2 & Norman Road
3. Norman Road & Rays Road
4. Spartan Lane & Rays Road
5. Rays Road & Memorial Drive

The report summarizes background and projected traffic at the study locations, analysis of traffic impacts including level of service (LOS) and conclusions and recommendations from the analysis.

Figure 1 depicts the site location in DeKalb County. The study intersections listed above are depicted in Figure 2. A copy of the development concept plan is included in the Appendix.

Figure 1. Vicinity Map

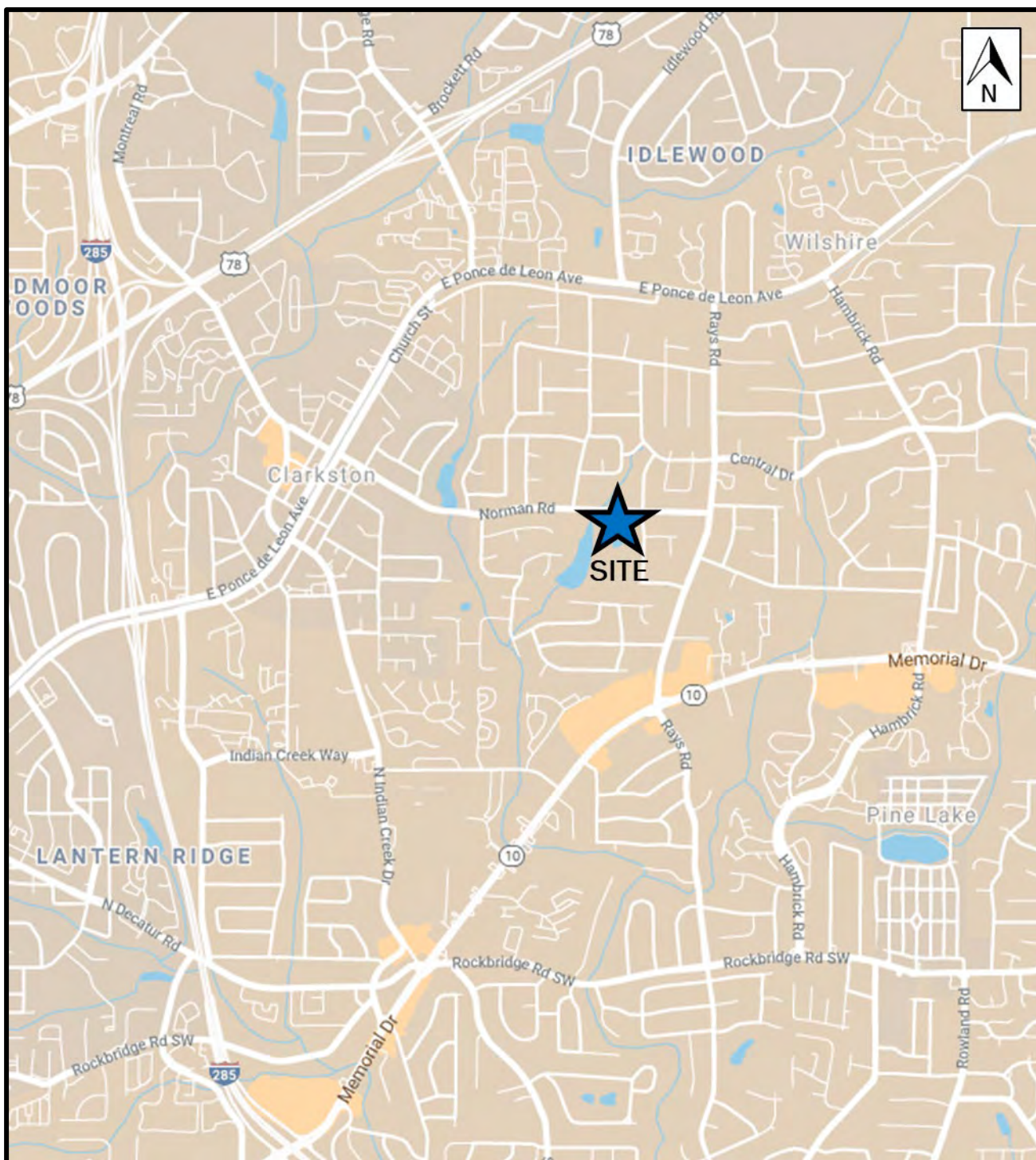
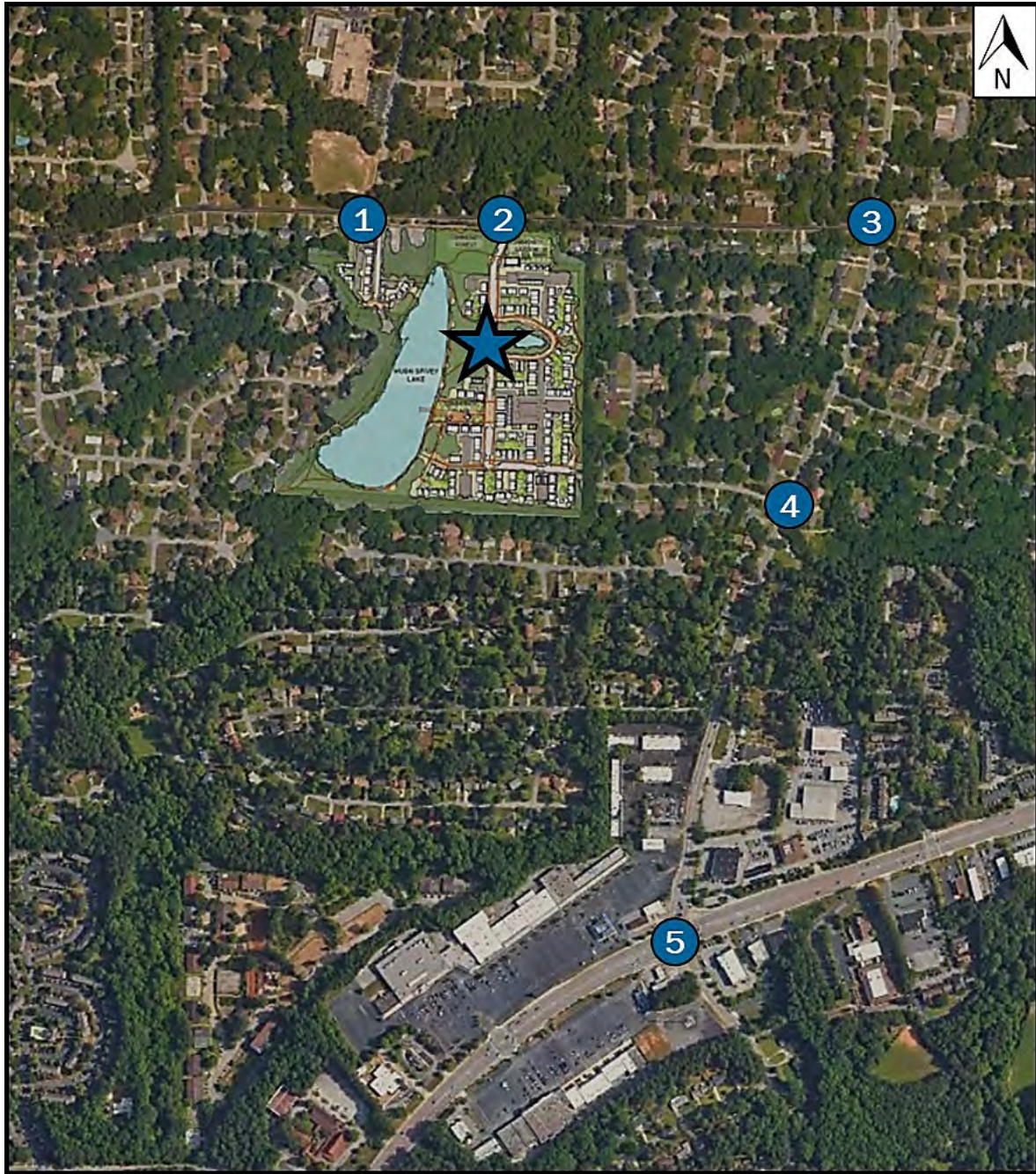

Figure 2. Site Location Aerial



1. Otello Avenue/ Driveway 1 & Norman Road
2. Driveway 2 & Norman Road
3. Norman Road & Rays Road
4. Spartan Lane & Rays Road
5. Rays Road & Memorial Drive

B. Existing Conditions

B.1. Transportation Facilities

Norman Road is an east-west, two-lane undivided, collector roadway with a posted speed of 35 MPH. The road is in a school zone beginning 0.2 mile west of its intersection with Otello Avenue and ending 0.1 mile east of said intersection. The roadway facilitates access to primarily residential land. The roadway will service two access points for the subject development.

Otello Road is a north-south, two-lane undivided, local roadway with a posted speed of 25 MPH. Jolly Elementary School is located along the roadway 400 feet north of its intersection with Norman Road. Northbound traffic is prohibited from 7:15 AM to 8:15 AM and 1:45 PM to 2:45 PM. Land uses along the roadway are residential and institutional.

Spartan Lane is an east-west, two-lane undivided, local residential roadway with a posted speed of 25 MPH. The roadway will service one access point for the subject development.

Rays Road is a north-south, two-lane undivided, collector roadway with a posted speed of 35 MPH. The roadway provides access to Memorial Drive approximately one mile south of its intersection with Norman Road. The roadway facilitates access to primarily residential land uses with commercial/retail land uses surrounding Memorial Drive. Rays Road has an AADT of about 10,700 vehicles per day near the study intersection.

Memorial Drive (SR-10) is a six-lane, major arterial roadway with a posted speed of 45 MPH. The roadway provides access to I-285 approximately two miles southwest of its intersection with Rays Road. There are a plethora of land uses along the roadway within the vicinity of the project including commercial/retail, institutional, medical, and residential. Memorial Drive has an AADT of about 40,800 vehicles per day near the study intersection.

B.2. Traffic Counts

Weekday peak period turning movement counts were collected at the existing intersections depicted in Figure 2 on Thursday, March 25, 2021 while schools were in session. Bi-directional traffic counts were also collected on Norman Road near the site on Thursday, March 25, 2021. The daily traffic recorded along Norman Road was 2,446 vehicles. The turning peak hour counts at the study intersections are shown in Figure 3 (Existing Traffic Volumes). The count worksheets are included in Appendix B.

Figure 3: Existing Volumes (2021)

##(##) → AM (PM) Peak Hour Traffic Volume
 - - - Proposed Driveway

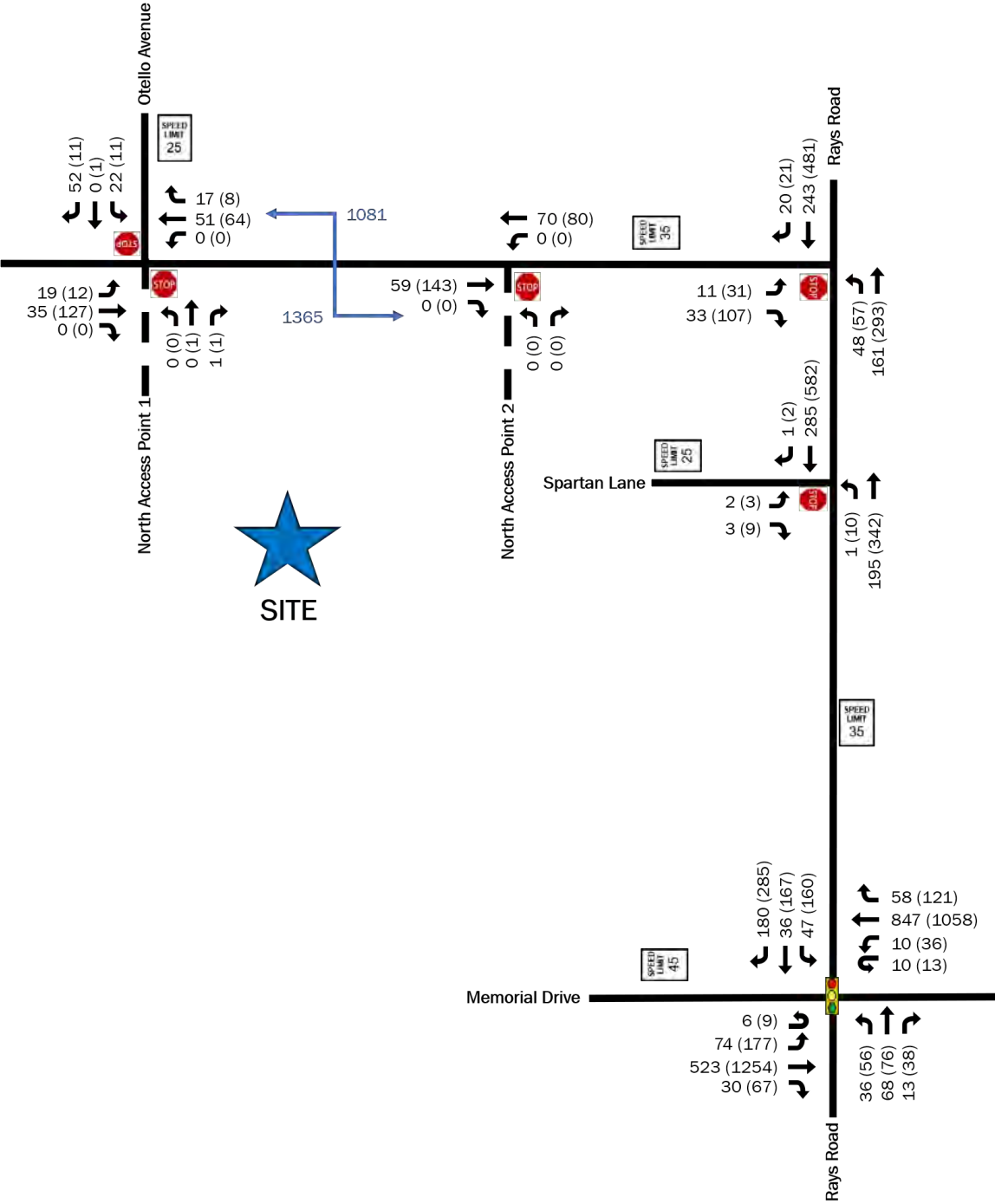

B.3. Baseline Adjustment

The analysis utilizes an adjustment factor to account for the decrease in traffic due to the COVID-19 pandemic. The factors were developed using counts from the Georgia Department of Transportation's (GDOT) Automated Traffic Signal Performance Measures (ATSPM). Turning movement counts recorded at the intersection of Memorial Drive (SR 10) and Rays Road in March 2019 were compared to counts recorded in March 2021 at the same intersection. From the data, the analysis uses a factor of 1.4 applied to the AM peak hour counts and a factor of 1.05 applied to the PM peak hour counts at each of the study intersections depicted in Figure 2. The adjusted volumes (Baseline Volumes) are depicted in Figure 4. The No-Build and Build scenarios in the study utilize these volumes as baseline conditions. The adjustment factor worksheet and supporting data are included in Appendix B.

Figure 4: Baseline Volumes (2021)

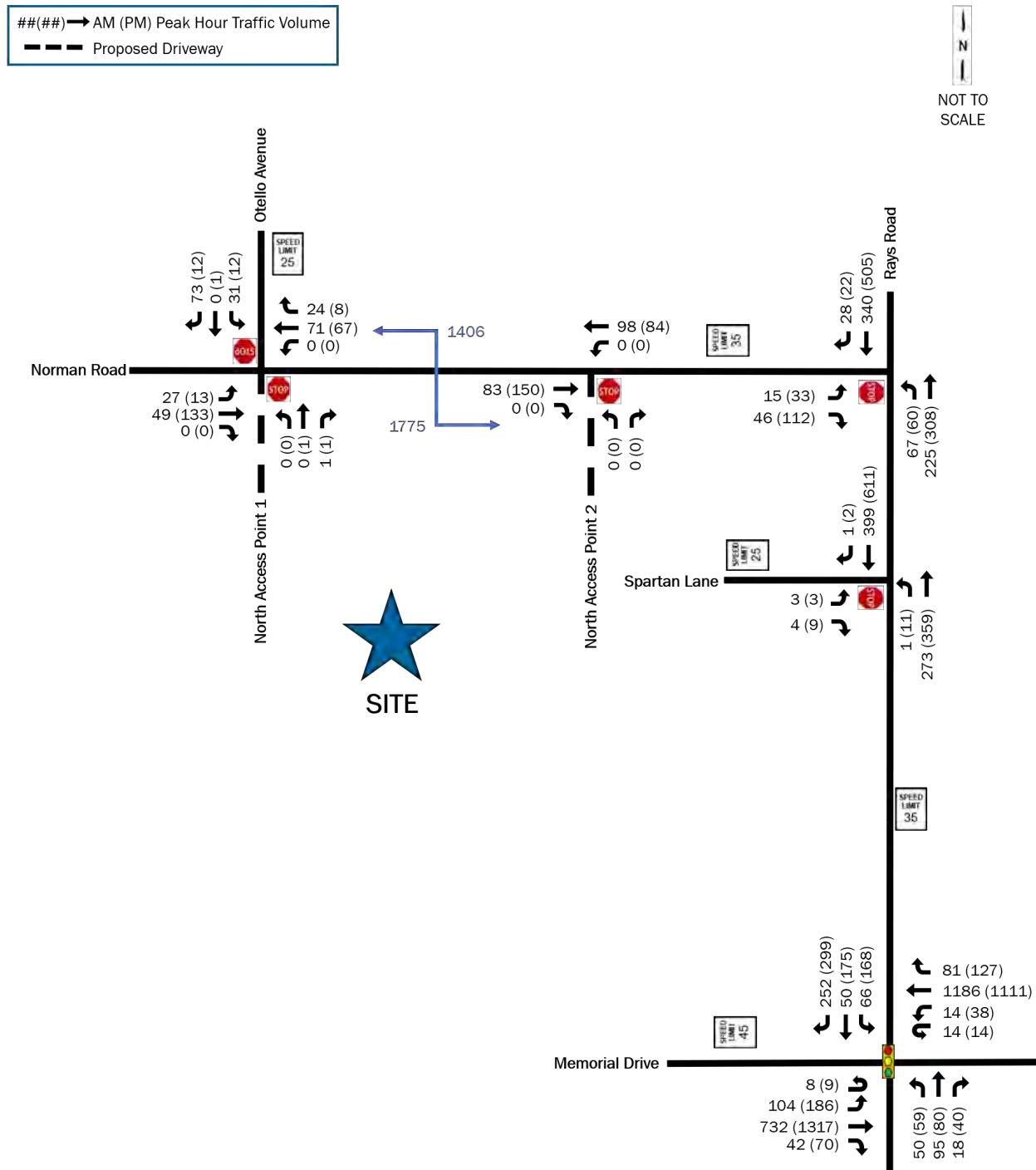

C. Future Conditions

C.1. Background Data Collection

The growth rate in the study area is based upon an analysis of historical traffic counts collected by the Georgia Department of Transportation (GDOT). The project is expected to be built-out in 2024. To account for ambient growth in the area, the baseline traffic counts were grown by 3.4% per year for three years. The growth rate considers historical GDOT traffic data collected along Rays Road, Memorial Drive, and Ponce de Leon Avenue. The expected volumes are depicted in Figure 5, 2024 No-Build Volumes. The historical counts and growth rate development worksheet are included in Appendix B.

C.2. Project Trip Generation

Table 1 summarizes the project trip generation calculated using the Institute of Transportation Engineers' (ITE) Trip Generation Manual, 10th Edition, 2017. The community consists of three types of dwelling units including 138 Two-Family Homes, 52 Townhomes, and 40 Single Family Detached Homes. The homes encompass two types of ITE Land Use Codes (LUC) including one for the single-family detached homes (LUC 210) and one for both the two-family home unit type and the townhome unit type (LUC 220). Table 1 below summarizes the daily and hourly trip generation of the proposed residential development. The scale of the project does not warrant trip reductions for pass-by and/or internal capture. Conservatively, the analysis does not consider reduced, generated trips to account for transit/multimodal use.

Table 1: Project Trip Generation

LAND USE	PERIOD	TOTAL	IN	OUT
Single Family Homes, LUC 210 (40 Dwelling Units)	Daily	448	224	224
	AM Peak Hour	33	8	25
	PM Peak Hour	42	26	16
*Two/Three Family Homes (190 Dwelling Units - 138 Two-Family Homes, 52 Townhomes)	Daily	1,396	698	698
	AM Peak Hour	88	20	68
	PM Peak Hour	105	66	39
Total Net Trips	Daily	1,844	922	922
	AM Peak Hour	121	28	93
	PM Peak Hour	147	92	55

*Study utilizes ITE (Institute of Transportation Engineers) Land Use Code *Multi-Family Housing Low-Rise (LUC 220)*

Figure 5: 2024 No-Build Traffic Volumes

###(##) → AM (PM) Peak Hour Traffic Volume
 - - - Proposed Driveway



NOT TO SCALE

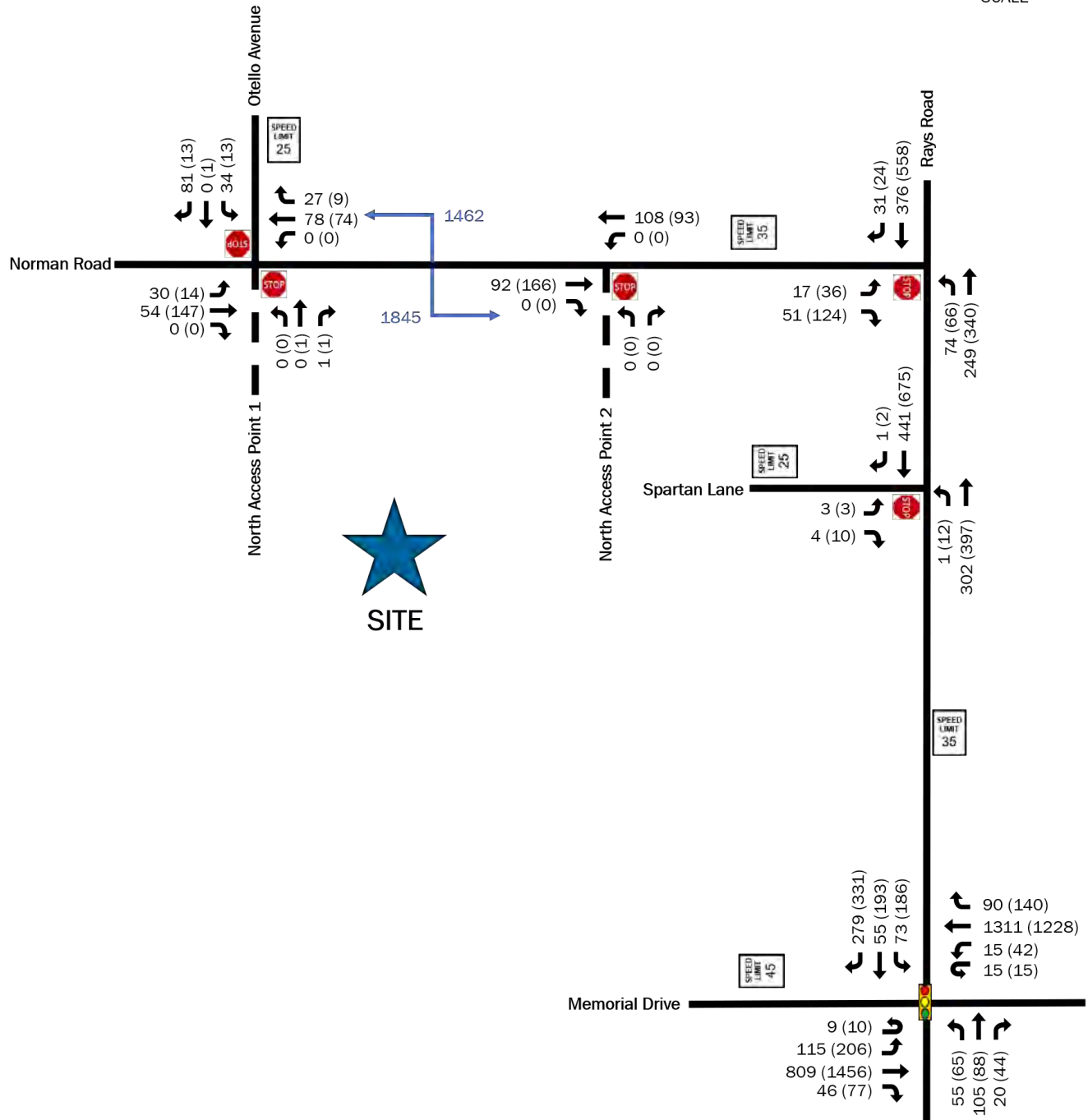

C.3. Trip Distribution and Assignment

The distribution and assignment of project trips for the development is based on an evaluation of traffic patterns typical of a residential development in addition to traffic patterns within the area, alongside an analysis of the collected traffic counts. Approximately 12% of the newly generated trips are expected to utilize Driveway 1 at Norman Road and Otello Avenue, 44% of the newly generated trips are expected to utilize Driveway 2 at Norman Road and the remaining 44% of the newly generated trips are expected to use Spartan Lane at Rays Road. An expected 34% of the generated trips will be distributed to/from the west via Norman Road, an estimated 18% of the newly generated trips will be distributed to/from the north via Rays Road. Approximately 48% of the newly generated trips will be distributed to/from the south via Memorial Drive. The trip generation is depicted in Figure 6. The project trips generated from the development utilize the trip distribution and are depicted in Figure 7. The No-Build plus project trips (Build Volumes) are depicted in Figure 8.

Figure 6: Trip Distribution

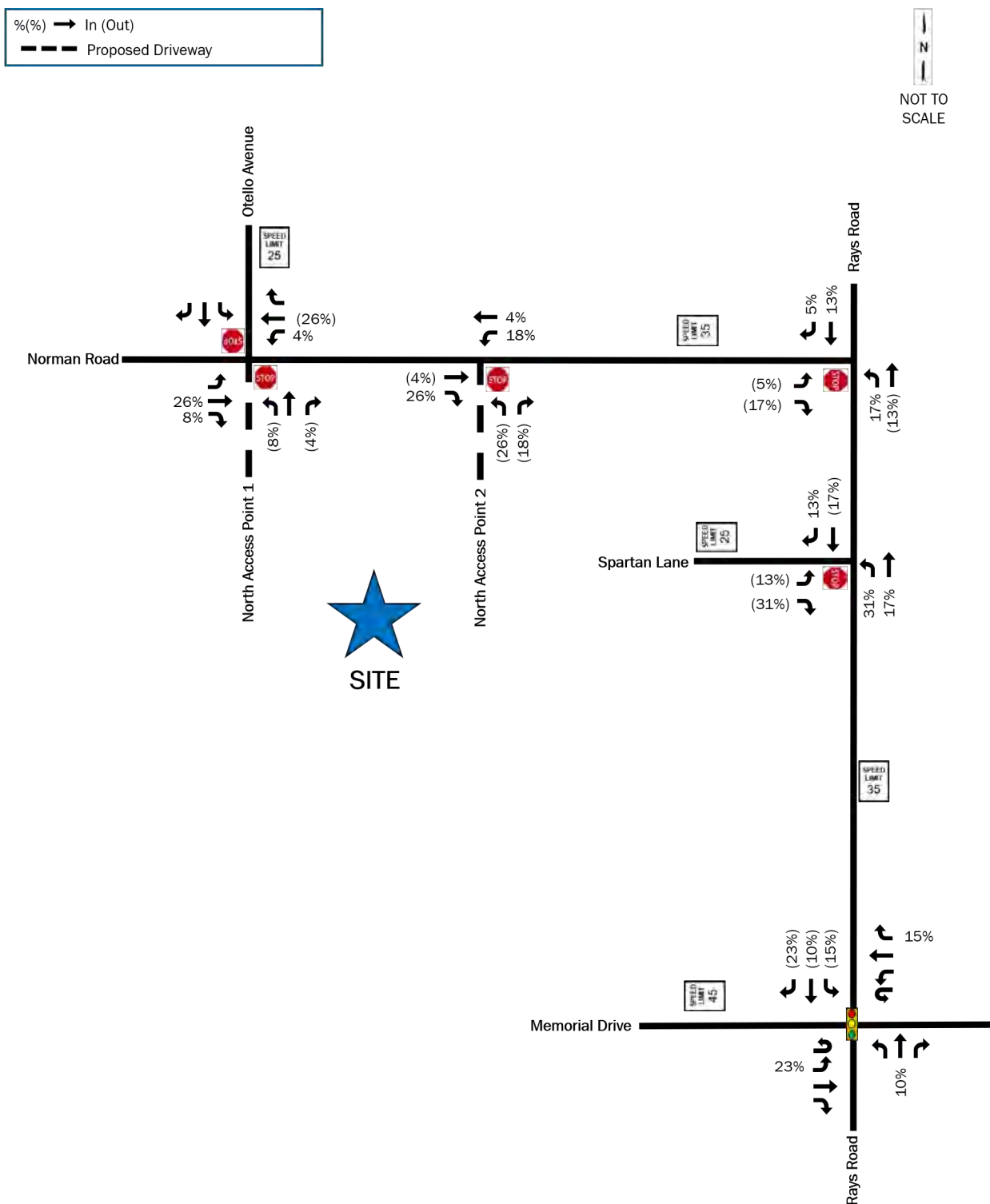
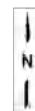

Figure 7: Project Development Trips

##(##) → AM (PM) Peak Hour Traffic Volume
 - - - Proposed Driveway

Trip Generation	Total	IN	OUT
AM Peak Hour	121	28	93
PM Peak Hour	147	92	55



NOT TO SCALE

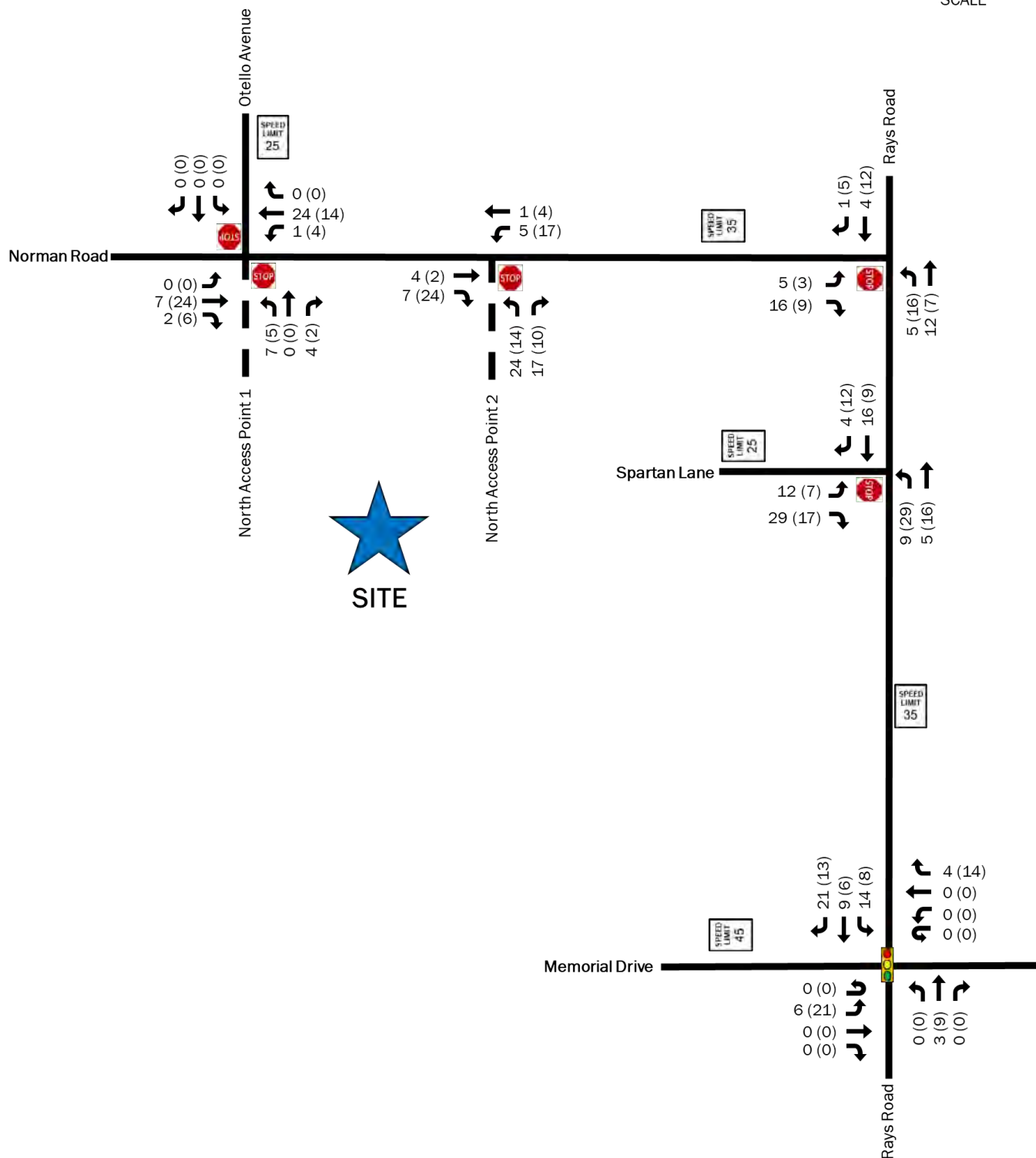
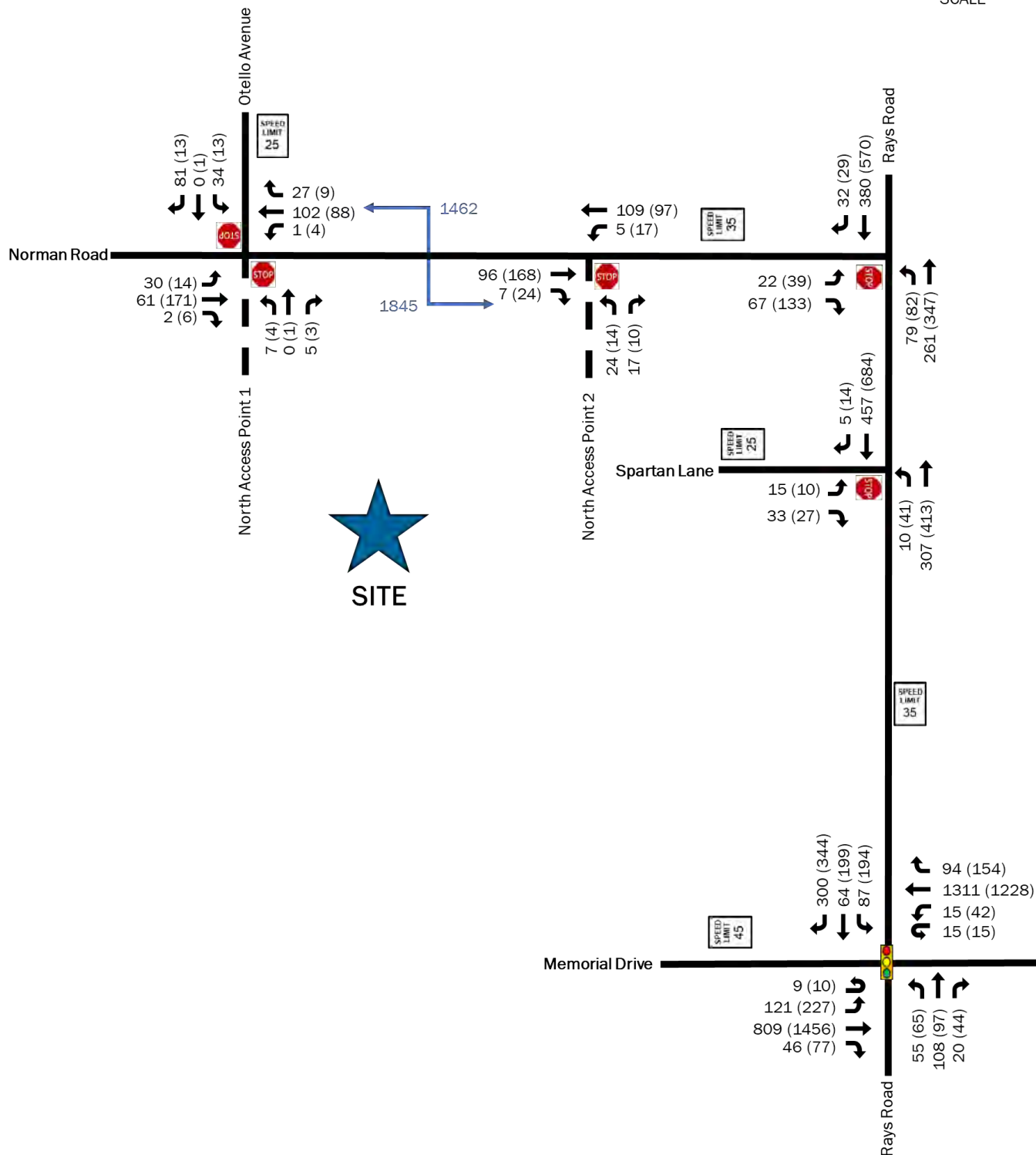

Figure 8: 2024 Build Traffic Volumes

##(##) → AM (PM) Peak Hour Traffic Volume
 - - - Proposed Driveway



NOT TO SCALE



D. Traffic Impact Analyses

The analysis in each of the scenarios for the study was performed using the traffic analysis software Synchro® 11. The analysis utilizes optimized signal timing with assumed cycle lengths of 120 seconds in the AM and PM peak hours. Average vehicular delays are calculated and reported as Levels of Service (LOS) as defined by the Highway Capacity Manual (HCM 6th Edition). HCM uses a grading system from A through F, where A is best (little to no delay) and F is worst (very heavy delay). HCM level of service (LOS) standards and Synchro® output reports are included in Appendix C.

D.1. 2021 Existing Capacity Analysis

The results of the 2021 existing conditions capacity analysis are shown in Table 2 and include analysis of the volumes presented in Figure 3.

Table 2: 2021 Existing Capacity Analysis

ID	Intersection	Control	Movement	AM		PM	
				Delay	LOS	Delay	LOS
1	Dwy 1/Otello Rd & Norman Rd	Stop-Control	NB	8.5	A	9.8	A
			SB	9.6	A	9.6	A
			EBL	7.4	A	7.5	A
			WBL	-	-	-	-
2	DWY 2 & Norman Rd	Stop-Control	NB	-	-	-	-
			WBL	-	-	-	-
3	Rays Rd & Norman Rd	Stop-Control	EB	11.1	B	17.6	C
			NBL	8	A	8.7	A
4	Rays Rd & Spartan Ln	Stop-Control	EB	10.9	B	14.8	B
			NBL	7.9	A	8.9	A
5	Rays Rd & Memorial Dr	Signal	EB	24.9	C	29.4	C
			WB	27.9	C	29.7	C
			NB	16.9	B	24.5	C
			SB	23.5	C	33.9	C
			Overall	25.6	C	30.1	C

The study assumes adequate operations as LOS D or better. As shown in Table 2, the overall traffic operations at the study intersection are satisfactory in existing conditions.

D.2. 2021 Baseline Capacity Analysis

The results of the 2021 baseline conditions capacity analysis are shown in Table 3 and include analysis of the volumes presented in Figure 4.

Table 3: 2021 Baseline Capacity Analysis

ID	Intersection	Control	Movement	AM		PM	
				Delay	LOS	Delay	LOS
1	Dwy 1/Otello Rd & Norman Rd	Stop-Control	NB	8.6	A	9.8	A
			SB	10.2	B	9.6	A
			EBL	7.5	A	7.5	A
			WBL	-	-	-	-
2	Dwy 2 & Norman Rd	Stop-Control	NB	-	-	-	-
			WBL	-	-	-	-
3	Rays Rd & Norman Rd	Stop-Control	EB	13.0	B	18.9	C
			NBL	8.4	A	8.9	A
4	Rays Rd & Spartan Ln	Stop-Control	EB	12.5	B	15.4	C
			NBL	8.2	A	9.0	A
5	Rays Rd & Memorial Dr	Signal	EB	24.9	C	30.2	C
			WB	27.8	C	30.6	C
			NB	22.5	C	25.7	C
			SB	32.5	C	35.6	D
			Overall	27.2	C	31.1	C

The study assumes adequate operations as LOS D or better. As shown in Table 3, the overall traffic operations at the study intersection are satisfactory in baseline conditions.

D.3. 2024 No-Build Capacity Analysis

The results of the No-Build capacity analysis are shown in Table 4 and include analysis of the volumes presented in Figure 5.

Table 4: 2024 No-Build Capacity Analysis

ID	Intersection	Control	Movement	AM		PM	
				Delay	LOS	Delay	LOS
1	DWY 1/Otello Rd & Norman Rd	Stop-Control	NB	8.6	A	10.0	B
			SB	10.5	B	9.8	A
			EBL	7.5	A	7.5	A
			WBL	-	-	-	-
2	DWY 2 & Norman Rd	Stop-Control	NB	-	-	-	-
			WBL	-	-	-	-
3	Rays Rd & Norman Rd	Stop-Control	EB	14.1	B	23.0	C
			NBL	8.5	A	9.1	A
4	Rays Rd & Spartan Ln	Stop-Control	EB	13.2	B	16.7	C
			NBL	8.4	A	9.3	A
5	Rays Rd & Memorial Dr	Signal	EB	25.8	C	30.9	C
			WB	29.7	C	31.4	C
			NB	24.6	C	28.9	C
			SB	36.5	D	40.7	D
			Overall	29.1	C	32.7	C

As shown in Table 4, under No-Build conditions with the calculated growth rate of 3.4% in the area, the intersections operate adequately at overall acceptable levels of services. The intersections do increase in delay (as expected with the growth rate) with all intersections operating at a level of service (LOS) D or better overall and at each approach.

D.4. 2024 Build Conditions Capacity Analysis

The results of the 2024 Build conditions intersection capacity analysis are shown in Table 5 for No-Build plus project volumes (Figure 8).

Table 5: 2024 Build Capacity Analysis

ID	Intersection	Control	Movement	AM		PM	
				Delay	LOS	Delay	LOS
1	DWY 1/Otello Rd & Norman Rd	Stop-Control	NB	10.7	B	10.5	B
			SB	10.8	B	10.1	B
			EBL	7.6	A	7.5	A
			WBL	7.4	A	7.6	A
2	DWY 2 & Norman Rd	Stop-Control	NB	9.6	A	10.2	B
			WBL	7.4	A	7.7	A
3	Rays Rd & Norman Rd	Stop-Control	EB	14.9	B	26.6	D
			NBL	8.6	A	9.3	A
4	Rays Rd & Spartan Ln	Stop-Control	EB	14.0	B	20.0	C
			NBL	8.5	A	9.6	A
5	Rays Rd & Memorial Dr	Signal	EB	26.9	C	32.6	C
			WB	31.0	C	33.6	C
			NB	24.7	C	28.8	C
			SB	37.8	D	40.8	D
			Overall	30.4	C	34.3	C

As shown in Table 5, the overall traffic from the additional project trips from the Spivey Lake Residential Development do not significantly affect the study network. With the added trips, the intersections do increase in delay (as expected), but do not change the overall levels of service experienced in No-Build conditions.

E. GDOT Turn Lane Evaluations

The need for turn lanes was evaluated for both driveways along Norman Road and the existing intersection of Rays Road and Spartan Lane using methodologies from the Georgia Department of Transportation (GDOT) Access Manual. The results of the evaluation are summarized in Table 6. From the evaluation, given the amount of expected traffic at Driveway 2, a right-turn deceleration lane is recommended.

Table 6: GDOT Turn Lane Evaluations

ID	Intersection	Movement/ Turn Lane	GDOT Criteria met?
1	Driveway 1 / Otello Rd & Norman Rd	WBL	NO
		EBR	NO
2	Driveway 2 & Norman Rd	WBL	NO
		EBR	YES
4	Rays Rd & Spartan Ln	NBL	NO
		SBR	NO

F. Conclusions

A new residential development is proposed for construction along Norman Road in DeKalb County, Georgia. The proposed development will consist of 40 single family homes, 138 two-family homes, and 52 townhomes. The proposed development will generate a daily total of 1,844 trips with 121 trips (28 entering and 93 exiting) during the AM peak hour, and 147 trips (92 entering and 55 exiting) during the PM peak hour. The following are conclusions from the study:

- Traffic operations at the study intersections are satisfactory (LOS D or better) in existing and baseline conditions.
- The conditions are expected to increase in delay as evidenced in the No-Build scenario due to the anticipated growth in the study area. Even with anticipated growth, the intersections are expected to operate at a level of service (LOS) D or better overall and at each approach.
- The addition of project traffic is expected to have little impact on the traffic operations at the study intersections. No improvements are recommended because the impact is minimal.
- Based on GDOT criteria, the eastern site driveway (Driveway 2) for the development warrants a right-turn deceleration lane. However, the installation of the turn lane is at the discretion of DeKalb County.

Based on the analysis prepared for the proposed development, improvements at the study intersections are not required to mitigate the impact of the proposed development.

APPENDIX A: CONCEPT PLAN



UNIT TYPE	TOTAL
SINGLE-FAMILY HOME	40
TWO-FAMILY HOME	138
TOWNHOUSE	52
TOTAL	230

230 UNITS / 34.88 AC = 6.59 UNITS / AC

PARKING	TOTAL
90° SPACE	213
PARALLEL SPACE	108
GARAGE SPACE	54
TOTAL	375

375 TOTAL PARKING SPACES
 - 3 CLUBHOUSE SPACES
 - 10 COMMUNITY GARDEN SPACES
 = **362 RESIDENTIAL PARKING SPACES**

362 SPACES / 230 UNITS = 1.57 PARKING RATIO

- COTTAGE COURT COURTYARD
- TRAIL
- BUILDING



SITE STUDY ILLUSTRATIVE PLAN
HUGH SPIVEY LAKE



RESIDENTIAL PROGRAM

BLOCK	SINGLE-FAMILY / TWO-FAMILY	ADU	TOWN-HOUSE	TOTAL	OFF-STREET PARKING
PA-1	11	16	-	27	26
PA-2	-	-	11	11	12
PA-3	-	-	4	4	6
PA-4	-	-	6	6	14
PA-5	-	-	16	16	17
COURT 1	7	10	5	22	31
COURT 2	12	6	-	18	22
COURT 3	7	6	5	18	23
COURT 4	12	7	-	19	24
COURT 5	6	5	5	16	26
COURT 6	14	6	-	20	24
COURT 7	11	1	-	12	11
COURT 8	10	3	-	13	11
COURT 9	11	2	-	13	13
COURT 10	9	6	-	15	13
TOTAL	110	68	52	230	273

230 UNITS / 34.88 AC = 6.59 UNITS / AC

1-STORY UNITS: APP. 10% (24 UNITS)
 2-STORY UNITS: APP 90% (206 UNITS)

COMMUNITY GARDEN	TOTAL	CLUBHOUSE	TOTAL
AREA	0.64 AC	SF	1,400 SF
PARKING	10 SPACES	PARKING	3 SPACES

ON-STREET PARKING	TOTAL
PARALLEL SPACE	89

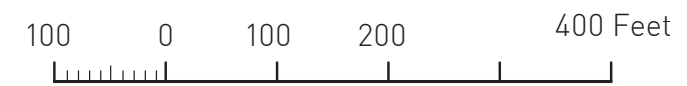

SITE STUDY CAPACITY DIAGRAM

HUGH SPIVEY LAKE



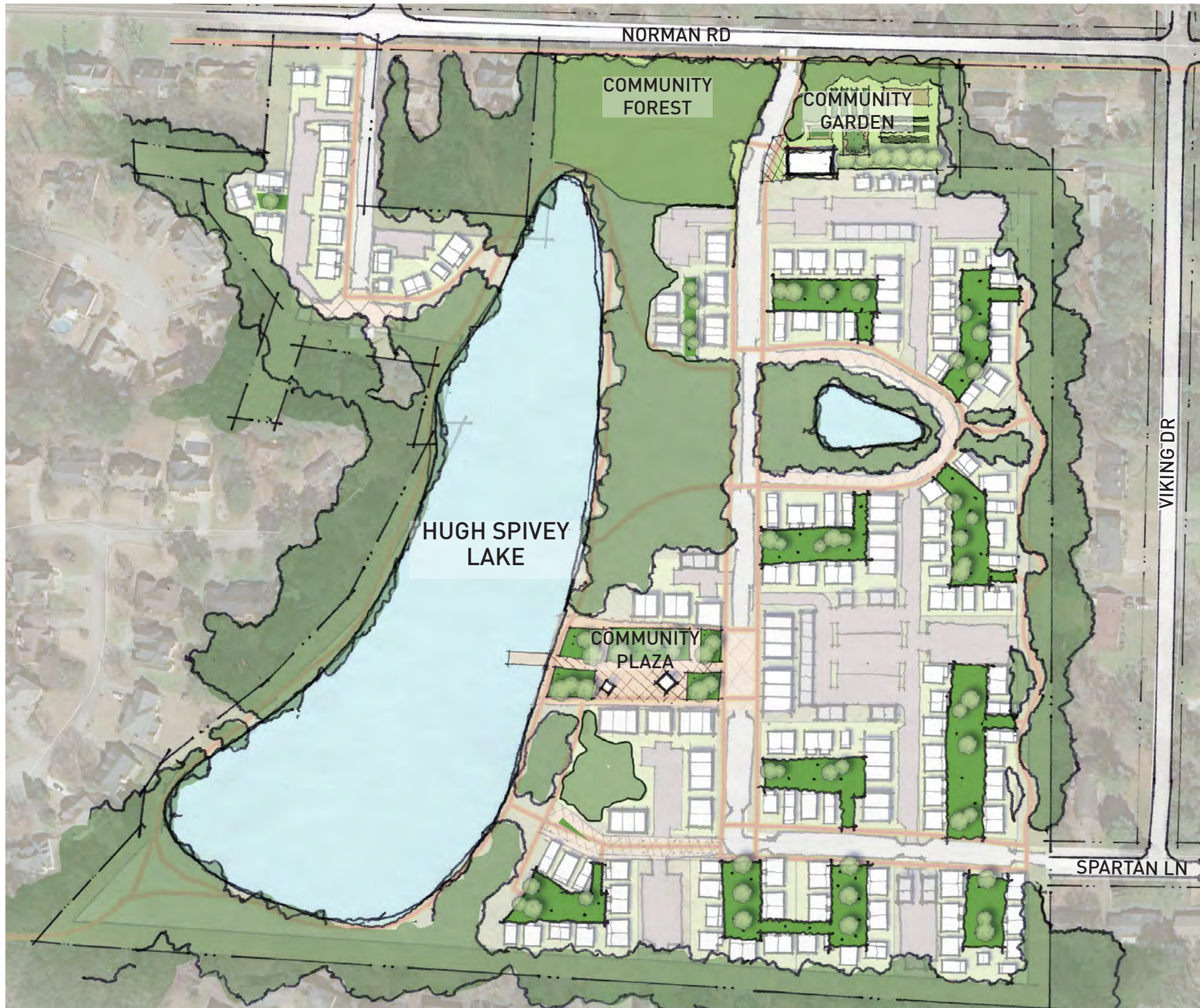

UNDEVELOPED LAND	TOTAL (AC)
TOTAL SITE AREA	34.88
TOTAL UNDEVELOPED AREA	18.00
18.00 AC UNDEVELOPED / 34.88 AC TOTAL = 51.6% OF LAND UNTOUCHED	

AREA OF COMMUNITY AMENITIES	TOTAL (AC)
COMMUNITY GARDEN	0.64
COMMUNITY FOREST	1.21
COMMUNITY PLAZA	0.65
COTTAGE COURT COURTYARDS	2.03
HUGH SPIVEY LAKE	7.00 AC
TOTAL	11.53 AC

TRAILS	TOTAL MILES
LINEAR DISTANCE OF TRAILS	2.1

- COTTAGE COURT COURTYARD
- TRAIL
- BUILDING



SITE STUDY GREEN SPACE DIAGRAM
HUGH SPIVEY LAKE

**APPENDIX B:
TRAFFIC COUNTS,
GROWTH RATE &
ADJUSTMENT FACTOR
WORKSHEETS**

Project ID: 21-180077-001
 Location: Otello Ave & Norman Rd
 City: Stone Mountain

Day: Thursday
 Date: 3/25/2021

Groups Printed - Cars, PU, Vans - Heavy Trucks

Start Time	Otello Ave Northbound						Otello Ave Southbound						Norman Rd Eastbound						Norman Rd Westbound						Int. Total	
	Left	Thru	Rgt	Uturn	Peds	App. Total	Left	Thru	Rgt	Uturn	Peds	App. Total	Left	Thru	Rgt	Uturn	Peds	App. Total	Left	Thru	Rgt	Uturn	Peds	App. Total		
7:00 AM	0	0	0	0	0	0	8	0	10	0	0	18	7	6	1	0	0	14	0	7	10	0	0	17	49	
7:15 AM	0	0	0	0	0	0	8	0	23	0	0	31	3	7	0	0	0	10	0	17	5	0	0	22	63	
7:30 AM	0	0	1	0	2	1	6	0	11	0	0	17	6	12	0	0	0	18	0	15	1	0	0	16	52	
7:45 AM	0	0	0	0	3	0	0	0	8	0	0	8	3	10	0	0	0	13	0	12	1	0	0	13	34	
Total	0	0	1	0	5	1	22	0	52	0	0	74	19	35	1	0	4	55	0	51	17	0	0	68	198	
8:00 AM	0	0	0	0	1	0	4	0	4	0	0	8	6	8	0	0	0	14	0	18	2	0	0	20	42	
8:15 AM	0	1	0	0	1	1	4	0	5	0	0	9	2	4	1	0	1	7	0	18	0	0	0	18	35	
8:30 AM	0	0	0	0	1	0	3	0	2	0	1	5	0	12	0	0	1	12	0	14	3	0	1	17	34	
8:45 AM	0	0	0	0	1	0	1	0	2	0	0	3	5	10	0	0	0	15	1	15	3	0	0	19	37	
Total	0	1	0	0	4	1	12	0	13	0	1	25	13	34	1	0	2	48	1	65	8	0	1	74	148	
BREAK																										
4:00 PM	0	0	0	0	1	0	3	0	2	0	0	5	1	25	0	0	2	26	0	18	1	0	0	19	50	
4:15 PM	0	0	0	0	0	0	6	0	2	0	0	8	5	22	0	0	2	27	1	15	1	0	0	17	52	
4:30 PM	0	0	0	0	0	0	6	0	1	0	0	7	3	25	0	0	0	28	0	13	2	0	0	15	50	
4:45 PM	0	0	0	0	0	0	7	0	0	0	0	7	3	22	0	0	1	25	1	15	0	0	0	16	48	
Total	0	0	0	0	1	0	22	0	5	0	0	27	12	94	0	0	5	106	2	61	4	0	0	67	200	
5:00 PM	0	0	0	0	1	0	3	0	2	0	0	5	5	28	0	0	0	33	0	12	1	0	0	13	51	
5:15 PM	0	0	0	0	4	0	2	1	4	0	0	7	3	30	0	0	2	33	0	20	5	0	2	25	65	
5:30 PM	0	0	1	0	0	1	1	0	3	0	0	4	3	37	0	0	2	40	0	19	0	0	0	19	64	
5:45 PM	0	1	0	0	0	1	5	0	2	0	0	7	1	32	0	0	0	33	0	13	2	0	0	15	56	
Total	0	1	1	0	5	2	11	1	11	0	0	23	12	127	0	0	4	139	0	64	8	0	2	72	236	
Grand Total	0	2	2	0	15	4	67	1	81	0	1	149	56	290	2	0	15	348	3	241	37	0	3	281	782	
Apprch %	0.0	50.0	50.0	0.0	375.0		45.0	0.7	54.4	0.0	0.7	16.1	83.3	0.6	0.0	4.3		1.1	85.8	13.2	0.0	1.1				
Total %	0.0	0.3	0.3	0.0	1.9	0.5	8.6	0.1	10.4	0.0	0.1	19.1	7.2	37.1	0.3	0.0	1.9	44.5	0.4	30.8	4.7	0.0	0.4	35.9		
Cars, PU, Vans	0	2	2	0	4		58	1	73	0		132	55	286	2	0	343	3	229	36	0	0	268	747		
% Cars, PU, Vans	0.0	100.0	100.0	0.0	100.0		86.6	100.0	90.1	0.0		88.6	98.2	98.6	100.0	0.0	98.6	100.0	95.0	97.3	0.0	0.0	95.4	95.5		
Heavy trucks	0	0	0	0	0		9	0	8	0		17	1	4	0	0	5	0	12	1	0	0	13	35		
% Heavy trucks	0.0	0.0	0.0	0.0	0.0		13.4	0.0	9.9	0.0		11.4	1.8	1.4	0.0	0.0	1.4	0.0	5.0	2.7	0.0	0.0	4.6	4.5		

Project ID: 21-180077-001
 Location: Otello Ave & Norman Rd
 City: Stone Mountain

PEAK HOURS

Day: Thursday
 Date: 3/25/2021

AM

Start Time	Otello Ave Northbound						Otello Ave Southbound						Norman Rd Eastbound						Norman Rd Westbound						Int. Total	
	Left	Thru	Rgt	Uturn	Peds	App. Total	Left	Thru	Rgt	Uturn	Peds	App. Total	Left	Thru	Rgt	Uturn	Peds	App. Total	Left	Thru	Rgt	Uturn	Peds	App. Total		
Peak Hour Analysis from 07:00 AM - 09:00 AM																										
Peak Hour for Entire Intersection Begins at 07:00 AM																										
7:00 AM	0	0	0	0	0		8	0	10	0	18	7	6	1	0	14	0	7	10	0	0	17	49			
7:15 AM	0	0	0	0	0		8	0	23	0	31	3	7	0	0	10	0	17	5	0	0	22	63			
7:30 AM	0	0	1	0	1		6	0	11	0	17	6	12	0	0	18	0	15	1	0	0	16	52			
7:45 AM	0	0	0	0	0		0	0	8	0	8	3	10	0	0	13	0	12	1	0	0	13	34			
Total Volume	0	0	1	0	1		22	0	52	0	74	19	35	1	0	55	0	51	17	0	0	68	198			
% App. Total	0.0	0.0	100.0	0.0	100		29.7	0.0	70.3	0.0	100	34.5	63.6	1.8	0.0	100	0.0	75.0	25.0	0.0	100					
PHF	0.250						0.597						0.764						0.773						0.786	
Cars, PU, Vans	0	0	1	0	1		17	0	45	0	62	19	32	1	0	52	0	45	16	0	0	61	176			
% Cars, PU, Vans	0.0	0.0	100.0	0.0	100.0		77.3	0.0	86.5	0.0	83.8	100.0	91.4	100.0	0.0	94.5	0.0	88.2	94.1	0.0	0.0	89.7	88.9			
Heavy trucks	0	0	0	0	0		5	0	7	0	12	0	3	0	0	3	0	6	1	0	0	7	22			
% Heavy trucks	0.0	0.0	0.0	0.0	0.0		22.7	0.0	13.5	0.0	16.2	0.0	8.6	0.0	0.0	5.5	0.0	11.8	5.9	0.0	10.3		11.1			

PM

Start Time	Otello Ave Northbound						Otello Ave Southbound						Norman Rd Eastbound						Norman Rd Westbound						Int. Total	
	Left	Thru	Rgt	Uturn	Peds	App. Total	Left	Thru	Rgt	Uturn	Peds	App. Total	Left	Thru	Rgt	Uturn	Peds	App. Total	Left	Thru	Rgt	Uturn	Peds	App. Total		
Peak Hour Analysis from 04:00 PM - 06:00 PM																										
Peak Hour for Entire Intersection Begins at 05:00 PM																										
5:00 PM	0	0	0	0	0		3	0	2	0	5	5	28	0	0	33	0	12	1	0	13	51				
5:15 PM	0	0	0	0	0		2	1	4	0	7	3	30	0	0	33	0	20	5	0	25	65				
5:30 PM	0	0	1	0	1		1	0	3	0	4	3	37	0	0	40	0	19	0	0	19	64				
5:45 PM	0	1	0	0	1		5	0	2	0	7	1	32	0	0	33	0	13	2	0	15	56				
Total Volume	0	1	1	0	2		11	1	11	0	23	12	127	0	0	139	0	64	8	0	72	236				
% App. Total	0.0	50.0	50.0	0.0	100		47.8	4.3	47.8	0.0	100	8.6	91.4	0.0	0.0	100	0.0	88.9	11.1	0.0	100					
PHF	0.500						0.821						0.869						0.720						0.908	
Cars, PU, Vans	0	1	1	0	2		11	1	11	0	23	11	126	0	0	137	0	62	8	0	70	232				
% Cars, PU, Vans	0.0	100.0	100.0	0.0	100.0		100.0	100.0	100.0	0.0	100	91.7	99.2	0.0	0.0	98.6	0.0	96.9	100.0	0.0	0.0	97.2	98.3			
Heavy trucks	0	0	0	0	0		0	0	0	0	0	1	1	0	0	2	0	2	0	0	0	2	4			
% Heavy trucks	0.0	0.0	0.0	0.0	0.0		0.0	0.0	0.0	0.0	0.0	8.3	0.8	0.0	0.0	1.4	0.0	3.1	0.0	0.0	2.8		1.7			

Project ID: 21-180077-002
 Location: Rays Rd & Norman Rd
 City: Stone Mountain

Day: Thursday
 Date: 3/25/2021

Groups Printed - Cars, PU, Vans - Heavy Trucks

Start Time	Rays Rd Northbound						Rays Rd Southbound						Norman Rd Eastbound						Norman Rd Westbound						Int. Total
	Left	Thru	Rgt	Uturm	Peds	App. Total	Left	Thru	Rgt	Uturm	Peds	App. Total	Left	Thru	Rgt	Uturm	Peds	App. Total	Left	Thru	Rgt	Uturm	Peds	App. Total	
7:00 AM	18	23	0	0	0	41	0	34	3	0	0	37	0	0	7	0	0	7	0	0	0	0	0	0	85
7:15 AM	13	44	0	0	0	57	0	42	5	0	0	47	5	0	9	0	0	14	0	0	0	0	0	0	118
7:30 AM	14	40	0	0	0	54	0	40	1	0	0	41	9	0	10	0	0	19	0	0	0	0	0	0	114
7:45 AM	12	37	0	0	0	49	0	45	4	0	0	49	5	0	9	0	0	14	0	0	0	0	0	0	112
Total	57	144	0	0	0	201	0	161	13	0	0	174	19	0	35	0	0	54	0	0	0	0	0	0	429
8:00 AM	11	39	0	0	0	50	0	61	6	0	0	67	3	0	8	0	0	11	0	0	0	0	0	0	128
8:15 AM	12	31	0	0	0	43	0	49	5	0	0	54	2	0	8	0	0	10	0	0	0	0	0	0	107
8:30 AM	10	48	0	0	0	58	0	63	6	0	0	69	1	0	7	0	0	8	0	0	0	0	0	0	135
8:45 AM	15	43	0	0	0	58	0	70	3	0	0	73	5	0	10	0	0	15	0	0	0	0	0	0	146
Total	48	161	0	0	0	209	0	243	20	0	0	263	11	0	33	0	0	44	0	0	0	0	0	0	516
BREAK																									
4:00 PM	10	69	0	0	0	79	0	110	2	0	0	112	5	0	22	0	0	27	0	0	0	0	0	0	218
4:15 PM	13	78	0	0	1	91	0	114	9	0	0	123	5	0	16	0	0	21	0	0	0	0	0	0	235
4:30 PM	10	73	0	0	0	83	0	143	6	0	0	149	11	0	21	0	0	32	0	0	0	0	0	0	264
4:45 PM	11	57	0	0	0	68	0	115	1	0	0	116	7	0	18	0	0	25	0	0	0	0	0	0	209
Total	44	277	0	0	1	321	0	482	18	0	0	500	28	0	77	0	0	105	0	0	0	0	0	0	926
5:00 PM	13	75	0	0	0	88	0	101	3	0	0	104	6	0	27	0	0	33	0	0	0	0	0	0	225
5:15 PM	15	63	0	0	0	78	0	143	12	0	0	155	6	0	20	0	0	26	0	0	0	0	0	0	259
5:30 PM	15	78	0	0	0	93	0	135	4	0	0	139	12	0	26	0	0	38	0	0	0	0	0	0	270
5:45 PM	14	77	0	0	0	91	0	102	2	0	0	104	7	0	34	0	0	41	0	0	0	0	0	0	236
Total	57	293	0	0	0	350	0	481	21	0	0	502	31	0	107	0	0	138	0	0	0	0	0	0	990
Grand Total	206	875	0	0	1	1081	0	1367	72	0	0	1439	89	0	252	0	0	341	0	0	0	0	0	0	2861
Apprch %	19.1	80.9	0.0	0.0	0.1		0.0	95.0	5.0	0.0	0.0		26.1	0.0	73.9	0.0	0.0		0.0	0.0	0.0	0.0	0.0		
Total %	7.2	30.6	0.0	0.0	0.0	37.8	0.0	47.8	2.5	0.0	0.0	50.3	3.1	0.0	8.8	0.0	0.0	11.9	0.0	0.0	0.0	0.0	0.0	0.0	
Cars, PU, Vans	202	849	0	0	0	1051	0	1334	68	0	0	1402	85	0	242	0	0	327	0	0	0	0	0	0	2780
% Cars, PU, Vans	98.1	97.0	0.0	0.0	0.0	97.2	0.0	97.6	94.4	0.0	0.0	97.4	95.5	0.0	96.0	0.0	0.0	95.9	0.0	0.0	0.0	0.0	0.0	0.0	97.2
Heavy trucks	4	26	0	0	0	30	0	33	4	0	0	37	4	0	10	0	0	14	0	0	0	0	0	0	81
% Heavy trucks	1.9	3.0	0.0	0.0	0.0	2.8	0.0	2.4	5.6	0.0	0.0	2.6	4.5	0.0	4.0	0.0	0.0	4.1	0.0	0.0	0.0	0.0	0.0	0.0	2.8

Project ID: 21-180077-002
 Location: Rays Rd & Norman Rd
 City: Stone Mountain

PEAK HOURS

Day: Thursday
 Date: 3/25/2021

AM

Start Time	Rays Rd Northbound						Rays Rd Southbound						Norman Rd Eastbound						Norman Rd Westbound						Int. Total
	Left	Thru	Rgt	Uturm	Peds	App. Total	Left	Thru	Rgt	Uturm	Peds	App. Total	Left	Thru	Rgt	Uturm	Peds	App. Total	Left	Thru	Rgt	Uturm	Peds	App. Total	
Peak Hour Analysis from 07:00 AM - 09:00 AM																									
Peak Hour for Entire Intersection Begins at 08:00 AM																									
8:00 AM	11	39	0	0	0	50	0	61	6	0	0	67	3	0	8	0	0	11	0	0	0	0	0	0	128
8:15 AM	12	31	0	0	0	43	0	49	5	0	0	54	2	0	8	0	0	10	0	0	0	0	0	0	107
8:30 AM	10	48	0	0	0	58	0	63	6	0	0	69	1	0	7	0	0	8	0	0	0	0	0	0	135
8:45 AM	15	43	0	0	0	58	0	70	3	0	0	73	5	0	10	0	0	15	0	0	0	0	0	0	146
Total Volume	48	161	0	0	0	209	0	243	20	0	0	263	11	0	33	0	0	44	0	0	0	0	0	0	516
% App. Total	23.0	77.0	0.0	0.0	0.0	100	0.0	92.4	7.6	0.0	0.0	100	25.0	0.0	75.0	0.0	0.0	100	0.0	0.0	0.0	0.0	0.0	0.0	
PHF	0.901						0.901						0.733						0.884						
Cars, PU, Vans	48	152	0	0	0	200	0	223	20	0	0	243	11	0	32	0	0	43	0	0	0	0	0	0	486
% Cars, PU, Vans	100.0	94.4	0.0	0.0	0.0	95.7	0.0	91.8	100.0	0.0	0.0	92.4	100.0	0.0	97.0	0.0	0.0	97.7	0.0	0.0	0.0	0.0	0.0	0.0	94.2
Heavy trucks	0	9	0	0	0	9	0	20	0	0	0	20	0	0	1	0	0	1	0	0	0	0	0	0	30
% Heavy trucks	0.0	5.6	0.0	0.0	0.0	4.3	0.0	8.2	0.0	0.0	0.0	7.6	0.0	0.0	3.0	0.0	2.3	0.0	0.0	0.0	0.0	0.0	0.0	0.0	5.8

PM

Start Time	Rays Rd Northbound						Rays Rd Southbound						Norman Rd Eastbound						Norman Rd Westbound						Int. Total
	Left	Thru	Rgt	Uturm	Peds	App. Total	Left	Thru	Rgt	Uturm	Peds	App. Total	Left	Thru	Rgt	Uturm	Peds	App. Total	Left	Thru	Rgt	Uturm	Peds	App. Total	
Peak Hour Analysis from 04:00 PM - 06:00 PM																									
Peak Hour for Entire Intersection Begins at 05:00 PM																									
5:00 PM	13	75	0	0	0	88	0	101	3	0	0	104	6	0	27	0	0	33	0	0	0	0	0	0	225
5:15 PM	15	63	0	0	0	78	0	143	12	0	0	155	6	0	20	0	0	26	0	0	0	0	0	0	259
5:30 PM	15	78	0	0	0	93	0	135	4	0	0	139	12	0	26	0	0	38	0	0	0	0	0	0	270
5:45 PM	14	77	0	0	0	91	0	102	2	0	0	104	7	0	34	0	0	41	0	0	0	0	0	0	236
Total Volume	57	293	0	0	0	350	0	481	21	0	0	502	31	0	107	0	0	138	0	0	0	0	0	0	990
% App. Total	16.3	83.7	0.0	0.0	0.0	100	0.0	95.8	4.2	0.0	0.0	100	22.5	0.0	77.5	0.0	0.0	100	0.0	0.0	0.0	0.0	0.0	0.0	
PHF	0.941						0.810						0.841						0.917						
Cars, PU, Vans	56	291	0	0	0	347	0	477	20	0	0	497	31	0	105	0	0	136	0	0	0	0	0	0	980
% Cars, PU, Vans	98.2	99.3	0.0	0.0	0.0	99.1	0.0	99.2	95.2	0.0	0.0	99.0	100.0	0.0	98.1	0.0	0.0	98.6	0.0	0.0	0.0	0.0	0.0	0.0	99.0
Heavy trucks	1	2	0	0	0	3	0	4	1	0	0	5	0	0	2	0	0	2	0	0	0	0	0	0	10
% Heavy trucks	1.8	0.7	0.0	0.0	0.0	0.9	0.0	0.8	4.8	0.0	0.0	1.0	0.0	0.0	1.9	0.0	1.4	0.0	0.0	0.0	0.0	0.0	0.0	1.0	

Project ID: 21-180077-004
 Location: Rays Rd & Memorial Dr/SR 10
 City: Stone Mountain

Day: Thursday
 Date: 3/25/2021

Groups Printed - Cars, PU, Vans - Heavy Trucks

Start Time	Rays Rd Northbound						Rays Rd Southbound						Memorial Dr/SR 10 Eastbound						Memorial Dr/SR 10 Westbound						Int. Total
	Left	Thru	Rgt	Utum	Peds	App. Total	Left	Thru	Rgt	Utum	Peds	App. Total	Left	Thru	Rgt	Utum	Peds	App. Total	Left	Thru	Rgt	Utum	Peds	App. Total	
7:00 AM	2	8	2	0	0	12	3	3	39	1	0	46	14	96	3	0	0	113	2	199	13	0	0	214	
7:15 AM	3	12	2	0	0	17	6	6	41	0	0	53	21	96	3	0	0	120	0	204	20	0	0	224	
7:30 AM	4	14	4	0	0	22	16	14	38	0	1	68	18	116	2	2	0	138	1	191	12	1	0	205	
7:45 AM	9	15	2	0	1	26	10	6	35	0	0	51	21	148	9	0	0	178	0	229	11	0	0	240	
Total	18	49	10	0	1	77	35	29	153	1	1	218	74	456	17	2	0	549	3	823	56	1	0	883	
8:00 AM	12	13	3	0	0	28	14	11	53	0	1	78	19	131	8	2	0	160	5	215	13	1	0	234	
8:15 AM	8	17	4	0	0	29	15	7	41	0	1	63	17	132	8	3	0	160	1	200	15	3	0	219	
8:30 AM	7	23	4	0	1	34	8	12	51	0	0	71	17	112	5	1	0	135	4	203	19	6	0	232	
8:45 AM	17	19	3	0	0	39	13	12	56	0	0	81	27	122	4	0	1	153	2	183	15	3	0	203	
Total	44	72	14	0	1	130	50	42	201	0	2	293	80	497	25	6	1	608	12	801	62	13	0	888	
BREAK																									
4:00 PM	18	17	13	0	1	48	50	43	76	0	0	169	59	269	21	1	0	350	5	254	28	8	0	295	
4:15 PM	20	14	6	0	0	40	40	28	71	0	0	139	55	275	14	4	0	348	10	248	36	6	0	300	
4:30 PM	13	18	6	0	2	37	39	48	68	0	0	155	46	297	16	4	0	363	12	276	21	10	1	319	
4:45 PM	7	17	10	0	0	34	48	41	66	0	1	155	33	253	17	4	0	307	8	243	26	5	1	282	
Total	58	66	35	0	3	159	177	160	281	0	1	618	193	1094	68	13	0	1368	35	1021	111	29	2	1196	
5:00 PM	15	20	6	0	0	41	30	31	65	0	1	126	42	304	14	2	0	362	6	280	29	3	0	318	
5:15 PM	14	17	12	0	1	43	41	48	74	0	0	163	43	327	18	3	0	391	9	266	32	3	0	310	
5:30 PM	16	26	11	0	1	53	51	45	88	0	0	184	48	327	10	3	0	388	12	259	30	3	0	304	
5:45 PM	11	13	9	0	2	33	38	43	58	0	0	139	44	296	25	1	0	366	9	253	30	4	1	296	
Total	56	76	38	0	4	170	160	167	285	0	1	612	177	1254	67	9	0	1507	36	1058	121	13	1	1228	
Grand Total	176	263	97	0	9	536	422	398	920	1	5	1741	524	3301	177	30	1	4032	86	3703	350	56	3	4195	
Apprch %	32.8	49.1	18.1	0.0	1.7		24.2	22.9	52.8	0.1	0.3		13.0	81.9	4.4	0.7	0.0		2.1	88.3	8.3	1.3	0.1		
Total %	1.7	2.5	0.9	0.0	0.1	5.1	4.0	3.8	8.8	0.0	0.0	16.6	5.0	31.4	1.7	0.3	0.0	38.4	0.8	35.3	3.3	0.5	0.0	39.9	
Cars, PU, Vans	172	261	97	0	5	530	404	395	897	1	1697	499	3186	170	30	3885	85	3567	336	55	4043	10155			
% Cars, PU, Vans	97.7	99.2	100.0	0.0	98.9	98.9	95.7	99.2	97.5	100.0	97.5	95.2	96.5	96.0	100.0	96.4	98.8	96.3	96.0	98.2	96.4	96.7			
Heavy trucks	4	2	0	0	6	6	18	3	23	0	44	25	115	7	0	147	1	136	14	1	152	349			
% Heavy trucks	2.3	0.8	0.0	0.0	1.1	1.1	4.3	0.8	2.5	0.0	2.5	4.8	3.5	4.0	0.0	3.6	1.2	3.7	4.0	1.8	3.6	3.3			

Project ID: 21-180077-004
 Location: Rays Rd & Memorial Dr/SR 10
 City: Stone Mountain

PEAK HOURS

Day: Thursday
 Date: 3/25/2021

AM

Start Time	Rays Rd Northbound						Rays Rd Southbound						Memorial Dr/SR 10 Eastbound						Memorial Dr/SR 10 Westbound						Int. Total
	Left	Thru	Rgt	Utum	Peds	App. Total	Left	Thru	Rgt	Utum	Peds	App. Total	Left	Thru	Rgt	Utum	Peds	App. Total	Left	Thru	Rgt	Utum	Peds	App. Total	
Peak Hour Analysis from 07:00 AM - 09:00 AM																									
Peak Hour for Entire Intersection Begins at 07:45 AM																									
7:45 AM	9	15	2	0	26		10	6	35	0	51		21	148	9	0	178		0	229	11	0	240	495	
8:00 AM	12	13	3	0	28		14	11	53	0	78		19	131	8	2	160		5	215	13	1	234	500	
8:15 AM	8	17	4	0	29		15	7	41	0	63		17	132	8	3	160		1	200	15	3	219	471	
8:30 AM	7	23	4	0	34		8	12	51	0	71		17	112	5	1	135		4	203	19	6	232	472	
Total Volume	36	68	13	0	117		47	36	180	0	263		74	523	30	6	633		10	847	58	10	925	1938	
% App. Total	30.8	58.1	11.1	0.0	100		17.9	13.7	68.4	0.0	100		11.7	82.6	4.7	0.9	100		1.1	91.6	6.3	1.1	100		
PHF	0.860						0.843						0.889						0.964						0.969
Cars, PU, Vans	36	67	13	0	116		42	36	167	0	245		67	488	29	6	590		9	805	54	10	878	1829	
% Cars, PU, Vans	100.0	98.5	100.0	0.0	99.1		89.4	100.0	92.8	0.0	93.2		90.5	93.3	96.7	100.0	93.2		90.0	95.0	93.1	100.0	94.9	94.4	
Heavy trucks	0	1	0	0	1		5	0	13	0	18		7	35	1	0	43		1	42	4	0	47	109	
% Heavy trucks	0.0	1.5	0.0	0.0	0.9		10.6	0.0	7.2	0.0	6.8		9.5	6.7	3.3	0.0	6.8		10.0	5.0	6.9	0.0	5.1	5.6	

PM

Start Time	Rays Rd Northbound						Rays Rd Southbound						Memorial Dr/SR 10 Eastbound						Memorial Dr/SR 10 Westbound						Int. Total
	Left	Thru	Rgt	Utum	Peds	App. Total	Left	Thru	Rgt	Utum	Peds	App. Total	Left	Thru	Rgt	Utum	Peds	App. Total	Left	Thru	Rgt	Utum	Peds	App. Total	
Peak Hour Analysis from 04:00 PM - 06:00 PM																									
Peak Hour for Entire Intersection Begins at 05:00 PM																									
5:00 PM	15	20	6	0	41		30	31	65	0	126		42	304	14	2	362		6	280	29	3	318	847	
5:15 PM	14	17	12	0	43		41	48	74	0	163		43	327	18	3	391		9	266	32	3	310	907	
5:30 PM	16	26	11	0	53		51	45	88	0	184		48	327	10	3	388		12	259	30	3	304	929	
5:45 PM	11	13	9	0	33		38	43	58	0	139		44	296	25	1	366		9	253	30	4	296	834	
Total Volume	56	76	38	0	170		160	167	285	0	612		177	1254	67	9	1507		36	1058	121	13	1228	3517	
% App. Total	32.9	44.7	22.4	0.0	100		26.1	27.3	46.6	0.0	100		11.7	83.2	4.4	0.6	100		2.9	86.2	9.9	1.1	100		
PHF	0.802						0.832						0.832						0.964						0.965
Cars, PU, Vans	55	76	38	0	169		157	166	282	0	605		173	1227	66	9	1475		36	1040	120	13	1209	3458	
% Cars, PU, Vans	98.2	100.0	100.0	0.0	99.4		98.1	99.4	98.9	0.0	98.9		97.7	97.8	98.5	100.0	97.9		100.0	98.3	99.2	100.0	98.5	98.3	
Heavy trucks	1	0	0	0	1		3	1	3	0	7		4	27	1	0	32		0	18	1	0	19	59	
% Heavy trucks	1.8	0.0	0.0	0.0	0.6		1.9	0.6	1.1	0.0	1.1		2.3	2.2	1.5	0.0	2.1		0.0	1.7	0.8	0.0	1.5	1.7	

VOLUME

Norman Rd Bet. Otello Ave & Viking Dr

Day: Thursday
Date: 3/25/2021

City: Stone Mountain
Project #: GA21_180078_001

DAILY TOTALS					NB	SB						Total
					0	0						2,446
							1,365					1,081
AM Period	NB	SB	EB	WB	TOTAL	PM Period	NB	SB	EB	WB	TOTAL	
00:00			4	3	7	12:00			16	14	30	
00:15			4	2	6	12:15			17	19	36	
00:30			4	4	8	12:30			18	12	30	
00:45			5	17	22	12:45			22	73	95	
01:00			6	2	8	13:00			22	16	38	
01:15			2	5	7	13:15			23	15	38	
01:30			3	3	6	13:30			22	22	44	
01:45			4	15	19	13:45			21	88	109	
02:00			4	2	6	14:00			23	29	52	
02:15			1	2	3	14:15			22	22	44	
02:30			1	4	5	14:30			26	14	40	
02:45			4	10	14	14:45			32	103	135	
03:00			1	0	1	15:00			40	14	54	
03:15			2	0	2	15:15			47	20	67	
03:30			1	0	1	15:30			42	20	62	
03:45			1	5	6	15:45			27	156	183	
04:00			0	1	1	16:00			26	15	41	
04:15			0	1	1	16:15			29	20	49	
04:30			3	1	4	16:30			33	15	48	
04:45			1	4	5	16:45			29	117	146	
05:00			2	1	3	17:00			32	17	49	
05:15			1	3	4	17:15			31	26	57	
05:30			6	2	8	17:30			41	16	57	
05:45			4	13	17	17:45			39	143	182	
06:00			4	4	8	18:00			29	17	46	
06:15			9	11	20	18:15			31	17	48	
06:30			4	21	25	18:30			38	15	53	
06:45			5	22	27	18:45			21	119	140	
07:00			7	21	28	19:00			22	11	33	
07:15			20	18	38	19:15			24	14	38	
07:30			18	21	39	19:30			20	7	27	
07:45			14	59	73	19:45			19	85	104	
08:00			11	20	31	20:00			12	18	30	
08:15			12	16	28	20:15			10	12	22	
08:30			10	19	29	20:30			15	11	26	
08:45			13	46	59	20:45			10	47	57	
09:00			14	15	29	21:00			8	4	12	
09:15			9	15	24	21:15			9	8	17	
09:30			13	10	23	21:30			15	14	29	
09:45			8	44	52	21:45			6	38	44	
10:00			9	8	17	22:00			11	6	17	
10:15			10	11	21	22:15			9	5	14	
10:30			14	13	27	22:30			9	10	19	
10:45			19	52	71	22:45			4	33	37	
11:00			17	25	42	23:00			2	1	3	
11:15			12	7	19	23:15			3	1	4	
11:30			16	15	31	23:30			8	3	11	
11:45			13	58	71	23:45			5	18	23	
TOTALS			345	420	765	TOTALS			1020	661	1681	
SPLIT %			45.1%	54.9%	31.3%	SPLIT %			60.7%	39.3%	68.7%	

DAILY TOTALS					NB	SB						Total
					0	0						2,446
							1,365					1,081
AM Peak Hour			10:45	06:30	06:45	PM Peak Hour			14:45	13:30	15:00	
AM Pk Volume			64	89	139	PM Pk Volume			161	90	237	
Pk Hr Factor			0.842	0.767	0.891	Pk Hr Factor			0.856	0.776	0.884	
7 - 9 Volume	0	0	105	143	248	4 - 6 Volume	0	0	260	142	402	
7 - 9 Peak Hour			07:15	08:00	07:15	4 - 6 Peak Hour			17:00	17:00	17:00	
7 - 9 Pk Volume	0	0	63	73	132	4 - 6 Pk Volume	0	0	143	80	223	
Pk Hr Factor	0.000	0.000	0.788	0.913	0.846	Pk Hr Factor	0.000	0.000	0.872	0.769	0.929	

Growth Rate Calculations

Percentage Growth											
Roadway	County	Traffic Count Station	2016 Traffic Volumes	2017 Traffic Volumes	2018 Traffic Volumes	2019 Traffic Volumes	2020 Traffic Volumes by Linear Regress.	2021 Traffic Volumes by Linear Regress.	2024 Traffic Volumes by Linear Regress.	Annual Growth 2020 to 2022	Annual Growth 2020 to 2025
Rays Rd	DeKalb	089-3995	9,860	10,100	10,500	10,700	11,020	11,312	12,188	2.6%	2.6%
Memorial Dr	DeKalb	089-3049	33,200	35,100	35,000	40,800	41,700	43,970	50,780	5.4%	5.2%
E Ponce de Leon Ave	DeKalb	089-3743	18,700	19,800	18,800	19,000	19,050	19,040	19,010	-0.1%	-0.1%
Weighted Average			61,760	65,000	64,300	70,500	71,770	74,322	81,978	3.6%	3.4%

Adjustment Factor Calculations

2019

	Eastbound	Westbound	Northbound	Southbound	Total
8:00 AM	971	1014	117	196	2298
6:00 PM	1560	721	143	350	2774

2021

	Eastbound	Westbound	Northbound	Southbound	Total
8:00 AM	576	807	87	171	1641
6:00 PM	1050	1311	122	303	2786

	Eastbound	Westbound	Northbound	Southbound	Total
	2019/2021	2019/2021	2019/2021	2019/2021	AVG
8:00 AM	1.69	1.26	1.40	1.15	1.37
6:00 PM	1.49	0.55	1.00	1.16	1.05

AM	1.40
PM	1.05

Signal

(<http://www.dot.ga.gov>)

Signal Selection

Signal ID

SR 10 @ Rays Road

Signal List

Signal Map

Region



Metric Type

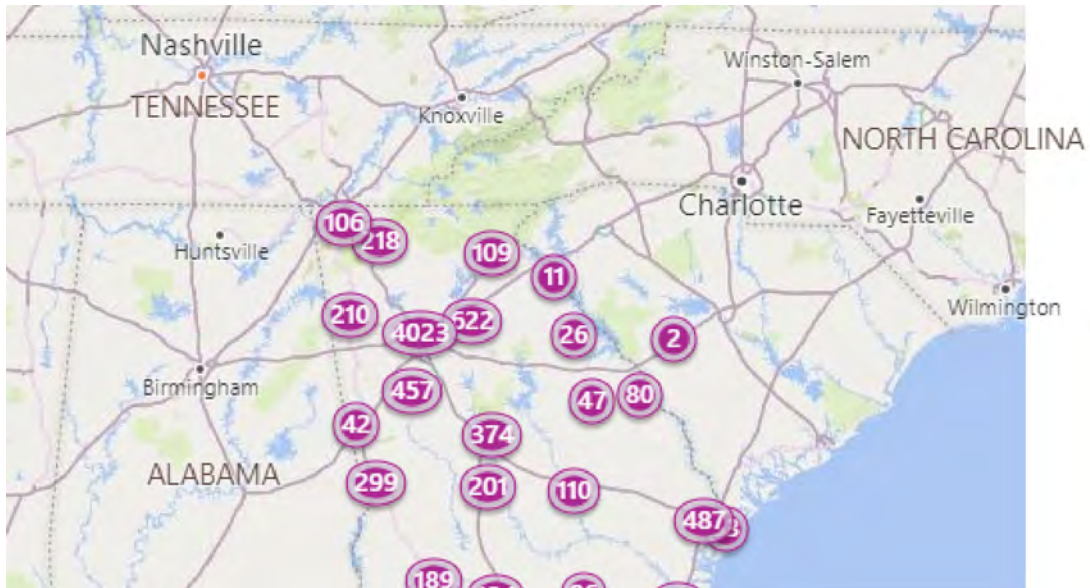



Chart Selection

Metrics List

- Purdue Phase Termination
- Split Monitor
- Pedestrian Delay
- Preemption Details
- Turning Movement Counts
- Purdue Coordination Diagram
- Approach Volume
- Approach Delay
- Arrivals On Red
- Purdue Split Failure
- Left Turn Gap Analysis

Turning Movement Counts Options

Thru Movement Y-axis Max

1000

Turn Movement Y- axis Max

300

Volume Bin Size

60

- Show MovementType Volume
- Show Total Volume
- Show Data Table

Date Selection

Start Date

03/20/2019 12:00 AM

March 2019

Su Mo Tu We Th Fr Sa

End Date

03/20/2019	11:59	PM	▼
------------	-------	----	---

Reset Date

Su	Mo	Tu	We	Th	Fr	Sa
					1	2
3	4	5	6	7	8	9
10	11	12	13	14	15	16
17	18	19	20	21	22	23
24	25	26	27	28	29	30
31						

Create Chart

	Vehicle														Vehicle Total
	Eastbound			Westbound			Northbound				Southbound				
	L	T	Total	L	T	Total	L	T	TR	Total	L	T	R	Total	
12:00 AM	35	292	327	3	116	119	4	7	4	15	23	20	34	77	538
1:00 AM	29	132	161	0	53	53	5	6	2	13	14	15	20	49	276
2:00 AM	23	111	134	3	53	56	6	7	3	16	9	8	17	34	240
3:00 AM	12	94	106	1	49	50	3	2	0	5	5	6	29	40	201
4:00 AM	8	92	100	3	78	81	5	12	5	22	10	10	37	57	260
5:00 AM	22	186	208	4	227	231	12	20	5	37	9	9	65	83	559
6:00 AM	52	434	486	6	710	716	27	32	16	75	17	27	91	135	1412
7:00 AM	53	839	892	10	1336	1346	55	80	32	167	25	45	160	230	2635
8:00 AM	37	934	971	23	991	1014	50	43	24	117	29	47	120	196	2298
9:00 AM	27	793	820	16	622	638	36	28	27	91	29	36	130	195	1744
10:00 AM	60	792	852	23	506	529	37	34	24	95	32	34	119	185	1661
11:00 AM	44	877	921	29	534	563	38	29	20	87	35	44	126	205	1776
12:00 PM	54	1061	1115	25	547	572	43	44	30	117	41	62	128	231	2035
1:00 PM	69	1164	1233	20	613	633	53	38	42	133	46	67	122	235	2234
2:00 PM	55	1304	1359	31	697	728	60	49	37	146	38	73	144	255	2488
3:00 PM	46	1341	1387	27	639	666	56	34	29	119	39	98	156	293	2105
4:00 PM	46	1601	1647	26	738	764	57	54	39	150	35	133	157	325	2105

5:00 PM	46	1595	1641	25	721	746	51	48	36	135	45	144	176	365	2887
6:00 PM	43	1517	1560	29	692	721	67	43	33	143	36	124	190	350	2774
7:00 PM	34	979	1013	22	481	503	40	34	30	104	34	83	127	244	1864
8:00 PM	42	868	910	32	421	453	36	35	20	91	33	63	104	200	1654
9:00 PM	44	699	743	23	291	314	32	24	15	71	34	37	78	149	1277
10:00 PM	46	511	557	12	256	268	11	12	19	42	23	28	68	119	986
11:00 PM	37	410	447	16	171	187	11	17	13	41	25	26	67	118	793
Total	964	18626	19590	409	11542	11951	795	732	505	2032	666	1239	2465	4370	37943

Signal

(<http://www.dot.ga.gov>)

Signal Selection

Signal ID

7740

Select

SR 10 @ Rays Road

Signal List

Signal Map

Region

--Select Region--



Metric Type

Turning Movement Counts

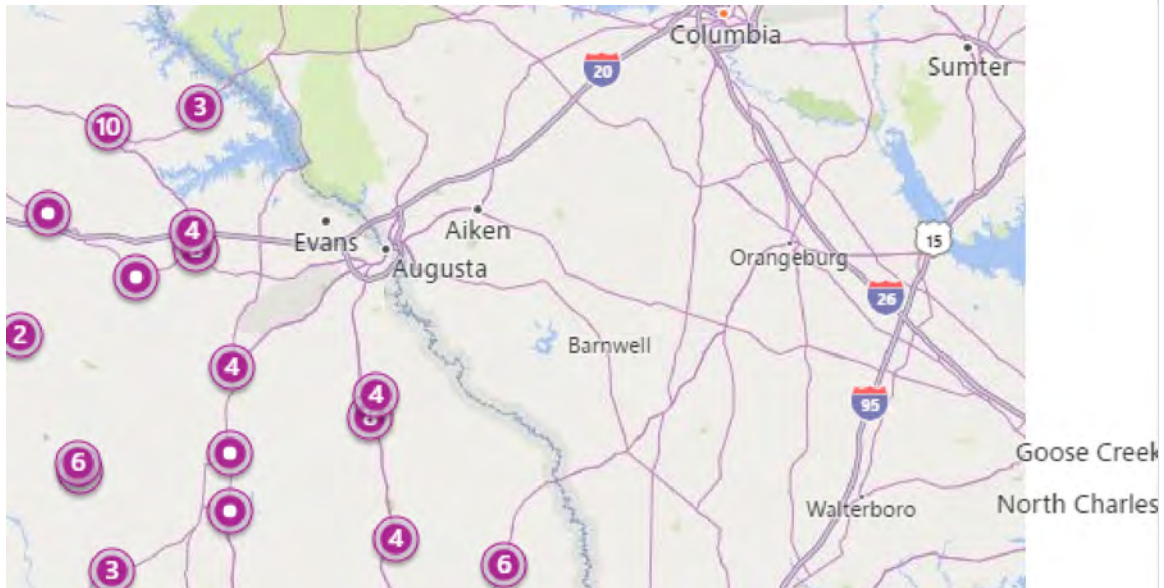



Chart Selection

Metrics List

- Purdue Phase Termination
- Split Monitor
- Pedestrian Delay
- Preemption Details
- Turning Movement Counts
- Purdue Coordination Diagram
- Approach Volume
- Approach Delay
- Arrivals On Red
- Purdue Split Failure
- Left Turn Gap Analysis

Turning Movement Counts Options

Thru Movement Y-axis Max

1000

Turn Movement Y- axis Max

300

Volume Bin Size

60

- Show MovementType Volume
- Show Total Volume
- Show Data Table

Date Selection

Start Date

03/24/2021 12:00 AM

◀ April 2021 ▶

Su Mo Tu We Th Fr Sa

End Date

03/24/2021	11:59	PM	▼
------------	-------	----	---

Reset Date

Su Mo Tu We Th Fr Sa

				1	2	3
4	5	6	7	8	9	10
11	12	13	14	15	16	17
18	19	20	21	22	23	24
25	26	27	28	29	30	

Create Chart

	Vehicle														Vehicle Total
	Eastbound			Westbound			Northbound				Southbound				
	L	T	Total	L	T	Total	L	T	TR	Total	L	T	R	Total	
12:00 AM	36	272	308	5	236	241	10	6	8	24	22	18	25	65	638
1:00 AM	31	234	265	4	127	131	7	9	2	18	15	16	22	53	467
2:00 AM	18	182	200	1	102	103	7	4	2	13	11	8	14	33	349
3:00 AM	22	124	146	2	125	127	4	3	5	12	6	10	19	35	320
4:00 AM	18	126	144	4	104	108	9	8	4	21	11	6	32	49	322
5:00 AM	17	281	298	4	269	273	7	18	5	30	9	7	58	74	675
6:00 AM	22	201	223	3	425	428	11	19	10	40	20	16	63	99	790
7:00 AM	13	220	233	5	521	526	15	18	9	42	10	14	60	84	885
8:00 AM	30	546	576	15	807	822	32	33	22	87	30	31	111	172	1657
9:00 AM	37	571	608	18	824	842	34	40	26	100	27	58	86	171	1721
10:00 AM	31	581	612	10	821	831	26	31	21	78	30	41	103	174	1695
11:00 AM	38	738	776	16	1009	1025	33	38	28	99	41	52	125	218	2118
12:00 PM	48	784	832	26	1396	1422	50	45	35	130	42	59	136	237	2621
1:00 PM	48	838	886	25	1436	1461	48	53	32	133	48	70	136	254	2734
2:00 PM	52	889	941	28	1533	1561	59	52	39	150	51	80	142	273	2925
3:00 PM	46	977	1023	26	1635	1661	51	43	43	137	46	103	139	288	3109
4:00 PM	53	973	1026	29	1833	1862	50	41	30	121	44	97	121	262	
5:00 PM	52	1136	1188	26	1599	1625	52	47	44	143	45	112	155	312	

6:00 PM	54	996	1050	17	1294	1311	47	44	31	122	44	121	138	303	2786
7:00 PM	48	837	885	29	940	969	53	31	30	114	46	49	107	202	2170
8:00 PM	54	697	751	16	816	832	44	43	30	117	43	64	56	163	1863
9:00 PM	46	563	609	17	643	660	20	22	22	64	35	44	87	166	1499
10:00 PM	44	419	463	13	428	441	15	17	19	51	29	32	61	122	1077
11:00 PM	42	330	372	16	280	296	12	20	8	40	28	31	42	101	809
Total	900	13515	14415	355	19203	19558	696	685	505	1886	733	1139	2038	3910	39769

APPENDIX C: SYNCHRO REPORTS

Intersection												
Int Delay, s/veh	4.4											
Movement	EBL	EBT	EBR	WBL	WBT	WBR	NBL	NBT	NBR	SBL	SBT	SBR
Lane Configurations		↕			↕			↕			↕	
Traffic Vol, veh/h	19	35	0	0	51	17	0	0	1	22	0	52
Future Vol, veh/h	19	35	0	0	51	17	0	0	1	22	0	52
Conflicting Peds, #/hr	0	0	0	0	0	0	0	0	0	0	0	0
Sign Control	Free	Free	Free	Free	Free	Free	Stop	Stop	Stop	Stop	Stop	Stop
RT Channelized	-	-	None	-	-	None	-	-	None	-	-	None
Storage Length	-	-	-	-	-	-	-	-	-	-	-	-
Veh in Median Storage, #	-	0	-	-	0	-	-	0	-	-	0	-
Grade, %	-	0	-	-	0	-	-	0	-	-	0	-
Peak Hour Factor	79	79	79	79	79	79	79	79	79	79	79	79
Heavy Vehicles, %	2	9	2	2	12	6	2	2	2	23	2	14
Mvmt Flow	24	44	0	0	65	22	0	0	1	28	0	66

Major/Minor	Major1		Major2		Minor1		Minor2					
Conflicting Flow All	87	0	0	44	0	0	201	179	44	169	168	76
Stage 1	-	-	-	-	-	-	92	92	-	76	76	-
Stage 2	-	-	-	-	-	-	109	87	-	93	92	-
Critical Hdwy	4.12	-	-	4.12	-	-	7.12	6.52	6.22	7.33	6.52	6.34
Critical Hdwy Stg 1	-	-	-	-	-	-	6.12	5.52	-	6.33	5.52	-
Critical Hdwy Stg 2	-	-	-	-	-	-	6.12	5.52	-	6.33	5.52	-
Follow-up Hdwy	2.218	-	-	2.218	-	-	3.518	4.018	3.318	3.707	4.018	3.426
Pot Cap-1 Maneuver	1509	-	-	1564	-	-	757	715	1026	750	725	953
Stage 1	-	-	-	-	-	-	915	819	-	883	832	-
Stage 2	-	-	-	-	-	-	896	823	-	865	819	-
Platoon blocked, %	-	-	-	-	-	-	-	-	-	-	-	-
Mov Cap-1 Maneuver	1509	-	-	1564	-	-	696	704	1026	740	713	953
Mov Cap-2 Maneuver	-	-	-	-	-	-	696	704	-	740	713	-
Stage 1	-	-	-	-	-	-	900	806	-	869	832	-
Stage 2	-	-	-	-	-	-	834	823	-	850	806	-

Approach	EB		WB		NB		SB	
HCM Control Delay, s	2.6		0		8.5		9.6	
HCM LOS					A		A	

Minor Lane/Major Mvmt	NBLn1	EBL	EBT	EBR	WBL	WBT	WBR	SBLn1
Capacity (veh/h)	1026	1509	-	-	1564	-	-	878
HCM Lane V/C Ratio	0.001	0.016	-	-	-	-	-	0.107
HCM Control Delay (s)	8.5	7.4	0	-	0	-	-	9.6
HCM Lane LOS	A	A	A	-	A	-	-	A
HCM 95th %tile Q(veh)	0	0	-	-	0	-	-	0.4

Intersection						
Int Delay, s/veh	0					
Movement	EBT	EBR	WBL	WBT	NBL	NBR
Lane Configurations						
Traffic Vol, veh/h	59	0	0	70	0	0
Future Vol, veh/h	59	0	0	70	0	0
Conflicting Peds, #/hr	0	0	0	0	0	0
Sign Control	Free	Free	Free	Free	Stop	Stop
RT Channelized	-	None	-	None	-	None
Storage Length	-	-	-	-	0	-
Veh in Median Storage, #	0	-	-	0	0	-
Grade, %	0	-	-	0	0	-
Peak Hour Factor	92	92	92	92	92	92
Heavy Vehicles, %	2	2	2	2	2	2
Mvmt Flow	64	0	0	76	0	0

Major/Minor	Major1	Major2	Minor1		
Conflicting Flow All	0	0	64	0	140
Stage 1	-	-	-	-	64
Stage 2	-	-	-	-	76
Critical Hdwy	-	-	4.12	-	6.42
Critical Hdwy Stg 1	-	-	-	-	5.42
Critical Hdwy Stg 2	-	-	-	-	5.42
Follow-up Hdwy	-	-	2.218	-	3.518
Pot Cap-1 Maneuver	-	-	1538	-	853
Stage 1	-	-	-	-	959
Stage 2	-	-	-	-	947
Platoon blocked, %	-	-	-	-	-
Mov Cap-1 Maneuver	-	-	1538	-	853
Mov Cap-2 Maneuver	-	-	-	-	853
Stage 1	-	-	-	-	959
Stage 2	-	-	-	-	947

Approach	EB	WB	NB
HCM Control Delay, s	0	0	0
HCM LOS			A

Minor Lane/Major Mvmt	NBLn1	EBT	EBR	WBL	WBT
Capacity (veh/h)	-	-	-	1538	-
HCM Lane V/C Ratio	-	-	-	-	-
HCM Control Delay (s)	0	-	-	0	-
HCM Lane LOS	A	-	-	A	-
HCM 95th %tile Q(veh)	-	-	-	0	-

Intersection						
Int Delay, s/veh	1.7					
Movement	EBL	EBR	NBL	NBT	SBT	SBR
Lane Configurations	T			T		T
Traffic Vol, veh/h	11	33	48	161	243	20
Future Vol, veh/h	11	33	48	161	243	20
Conflicting Peds, #/hr	0	0	0	0	0	0
Sign Control	Stop	Stop	Free	Free	Free	Free
RT Channelized	-	None	-	None	-	None
Storage Length	0	-	-	-	-	-
Veh in Median Storage, #	0	-	-	0	0	-
Grade, %	0	-	-	0	0	-
Peak Hour Factor	88	88	88	88	88	88
Heavy Vehicles, %	2	3	2	6	8	2
Mvmt Flow	13	38	55	183	276	23

Major/Minor	Minor2	Major1		Major2	
Conflicting Flow All	581	288	299	0	0
Stage 1	288	-	-	-	-
Stage 2	293	-	-	-	-
Critical Hdwy	6.42	6.23	4.12	-	-
Critical Hdwy Stg 1	5.42	-	-	-	-
Critical Hdwy Stg 2	5.42	-	-	-	-
Follow-up Hdwy	3.518	3.327	2.218	-	-
Pot Cap-1 Maneuver	476	749	1262	-	-
Stage 1	761	-	-	-	-
Stage 2	757	-	-	-	-
Platoon blocked, %				-	-
Mov Cap-1 Maneuver	453	749	1262	-	-
Mov Cap-2 Maneuver	453	-	-	-	-
Stage 1	724	-	-	-	-
Stage 2	757	-	-	-	-

Approach	EB	NB	SB
HCM Control Delay, s	11.1	1.8	0
HCM LOS	B		

Minor Lane/Major Mvmt	NBL	NBT	EBLn1	SBT	SBR
Capacity (veh/h)	1262	-	644	-	-
HCM Lane V/C Ratio	0.043	-	0.078	-	-
HCM Control Delay (s)	8	0	11.1	-	-
HCM Lane LOS	A	A	B	-	-
HCM 95th %tile Q(veh)	0.1	-	0.3	-	-

Intersection						
Int Delay, s/veh	0.1					
Movement	EBL	EBR	NBL	NBT	SBT	SBR
Lane Configurations	T			T		
Traffic Vol, veh/h	2	3	1	195	285	1
Future Vol, veh/h	2	3	1	195	285	1
Conflicting Peds, #/hr	0	0	0	0	0	0
Sign Control	Stop	Stop	Free	Free	Free	Free
RT Channelized	-	None	-	None	-	None
Storage Length	0	-	-	-	-	-
Veh in Median Storage, #	0	-	-	0	0	-
Grade, %	0	-	-	0	0	-
Peak Hour Factor	90	90	90	90	90	90
Heavy Vehicles, %	2	2	2	6	7	2
Mvmt Flow	2	3	1	217	317	1





















Major/Minor	Minor2	Major1	Major2			
Conflicting Flow All	537	318	318	0	-	0
Stage 1	318	-	-	-	-	-
Stage 2	219	-	-	-	-	-
Critical Hdwy	6.42	6.22	4.12	-	-	-
Critical Hdwy Stg 1	5.42	-	-	-	-	-
Critical Hdwy Stg 2	5.42	-	-	-	-	-
Follow-up Hdwy	3.518	3.318	2.218	-	-	-
Pot Cap-1 Maneuver	505	723	1242	-	-	-
Stage 1	738	-	-	-	-	-
Stage 2	817	-	-	-	-	-
Platoon blocked, %				-	-	-
Mov Cap-1 Maneuver	504	723	1242	-	-	-
Mov Cap-2 Maneuver	504	-	-	-	-	-
Stage 1	737	-	-	-	-	-
Stage 2	817	-	-	-	-	-

Approach	EB	NB	SB
HCM Control Delay, s	10.9	0	0
HCM LOS	B		

Minor Lane/Major Mvmt	NBL	NBT	EBLn1	SBT	SBR
Capacity (veh/h)	1242	-	616	-	-
HCM Lane V/C Ratio	0.001	-	0.009	-	-
HCM Control Delay (s)	7.9	0	10.9	-	-
HCM Lane LOS	A	A	B	-	-
HCM 95th %tile Q(veh)	0	-	0	-	-

HCM 6th Signalized Intersection Summary
5: Rays Rd & Memorial Dr

Spivey Lake Residential
Existing AM

												
Movement	EBU	EBL	EBT	EBR	WBU	WBL	WBT	WBR	NBL	NBT	NBR	SBL
Lane Configurations												
Traffic Volume (veh/h)	6	74	523	30	10	10	847	58	36	68	13	47
Future Volume (veh/h)	6	74	523	30	10	10	847	58	36	68	13	47
Initial Q (Qb), veh		0	0	0		0	0	0	0	0	0	0
Ped-Bike Adj(A_pbT)		1.00		1.00		1.00		1.00	1.00		1.00	1.00
Parking Bus, Adj		1.00	1.00	1.00		1.00	1.00	1.00	1.00	1.00	1.00	1.00
Work Zone On Approach			No				No			No		
Adj Sat Flow, veh/h/ln		1752	1796	1856		1752	1826	1796	1870	1870	1870	1737
Adj Flow Rate, veh/h		76	539	0		10	873	0	37	70	13	48
Peak Hour Factor		0.97	0.97	0.97		0.97	0.97	0.97	0.97	0.97	0.97	0.97
Percent Heavy Veh, %		10	7	3		10	5	7	2	2	2	11
Cap, veh/h		163	1455			40	1290		561	1069	193	130
Arrive On Green		0.05	0.30	0.00		0.01	0.26	0.00	0.03	0.36	0.36	0.04
Sat Flow, veh/h		3237	4904	1572		3237	4985	1522	1781	3006	544	3209
Grp Volume(v), veh/h		76	539	0		10	873	0	37	41	42	48
Grp Sat Flow(s),veh/h/ln		1618	1635	1572		1618	1662	1522	1781	1777	1772	1605
Q Serve(g_s), s		1.9	7.1	0.0		0.2	12.8	0.0	1.1	1.2	1.3	1.2
Cycle Q Clear(g_c), s		1.9	7.1	0.0		0.2	12.8	0.0	1.1	1.2	1.3	1.2
Prop In Lane		1.00		1.00		1.00		1.00	1.00		0.31	1.00
Lane Grp Cap(c), veh/h		163	1455			40	1290		561	632	631	130
V/C Ratio(X)		0.47	0.37			0.25	0.68		0.07	0.06	0.07	0.37
Avail Cap(c_a), veh/h		477	2948			357	2813		696	632	631	354
HCM Platoon Ratio		1.00	1.00	1.00		1.00	1.00	1.00	1.00	1.00	1.00	1.00
Upstream Filter(l)		1.00	1.00	0.00		1.00	1.00	0.00	1.00	1.00	1.00	1.00
Uniform Delay (d), s/veh		37.6	22.6	0.0		39.9	27.1	0.0	15.5	17.3	17.3	38.1
Incr Delay (d2), s/veh		2.1	0.2	0.0		3.2	0.6	0.0	0.0	0.2	0.2	1.7
Initial Q Delay(d3),s/veh		0.0	0.0	0.0		0.0	0.0	0.0	0.0	0.0	0.0	0.0
%ile BackOfQ(50%),veh/ln		0.7	2.5	0.0		0.1	4.7	0.0	0.4	0.5	0.5	0.5
Unsig. Movement Delay, s/veh												
LnGrp Delay(d),s/veh		39.7	22.8	0.0		43.0	27.8	0.0	15.5	17.5	17.5	39.8
LnGrp LOS		D	C			D	C		B	B	B	D
Approach Vol, veh/h			615	A			883	A		120		
Approach Delay, s/veh			24.9				27.9			16.9		
Approach LOS			C				C			B		
Timer - Assigned Phs	1	2	3	4	5	6	7	8				
Phs Duration (G+Y+Rc), s	10.1	27.1	8.8	35.5	7.0	30.2	9.3	35.0				
Change Period (Y+Rc), s	6.0	6.0	6.0	6.0	6.0	6.0	6.0	6.0				
Max Green Setting (Gmax), s	12.0	46.0	9.0	29.0	9.0	49.0	9.0	29.0				
Max Q Clear Time (g_c+I1), s	3.9	14.8	3.1	9.2	2.2	9.1	3.2	3.3				
Green Ext Time (p_c), s	0.1	6.3	0.0	0.7	0.0	3.7	0.0	0.4				
Intersection Summary												
HCM 6th Ctrl Delay			25.6									
HCM 6th LOS			C									
Notes												
User approved ignoring U-Turning movement.												
Unsignalized Delay for [EBR, WBR] is excluded from calculations of the approach delay and intersection delay.												

HCM 6th Signalized Intersection Summary
 5: Rays Rd & Memorial Dr

Spivey Lake Residential
 Existing AM



Movement	SBT	SBR
Lane Configurations	↑↑	↑
Traffic Volume (veh/h)	36	180
Future Volume (veh/h)	36	180
Initial Q (Qb), veh	0	0
Ped-Bike Adj(A_pbT)		1.00
Parking Bus, Adj	1.00	1.00
Work Zone On Approach	No	
Adj Sat Flow, veh/h/ln	1870	1796
Adj Flow Rate, veh/h	37	186
Peak Hour Factor	0.97	0.97
Percent Heavy Veh, %	2	7
Cap, veh/h	1285	551
Arrive On Green	0.36	0.36
Sat Flow, veh/h	3554	1522
Grp Volume(v), veh/h	37	186
Grp Sat Flow(s),veh/h/ln	1777	1522
Q Serve(g_s), s	0.5	7.2
Cycle Q Clear(g_c), s	0.5	7.2
Prop In Lane		1.00
Lane Grp Cap(c), veh/h	1285	551
V/C Ratio(X)	0.03	0.34
Avail Cap(c_a), veh/h	1285	551
HCM Platoon Ratio	1.00	1.00
Upstream Filter(l)	1.00	1.00
Uniform Delay (d), s/veh	16.8	18.9
Incr Delay (d2), s/veh	0.0	1.7
Initial Q Delay(d3),s/veh	0.0	0.0
%ile BackOfQ(50%),veh/ln	0.2	0.3
Unsig. Movement Delay, s/veh		
LnGrp Delay(d),s/veh	16.8	20.6
LnGrp LOS	B	C
Approach Vol, veh/h	271	
Approach Delay, s/veh	23.5	
Approach LOS	C	
Timer - Assigned Phs		

Intersection												
Int Delay, s/veh	1.4											
Movement	EBL	EBT	EBR	WBL	WBT	WBR	NBL	NBT	NBR	SBL	SBT	SBR
Lane Configurations		↕			↕			↕			↕	
Traffic Vol, veh/h	12	127	0	0	64	8	0	1	1	11	1	11
Future Vol, veh/h	12	127	0	0	64	8	0	1	1	11	1	11
Conflicting Peds, #/hr	0	0	0	0	0	0	0	0	0	0	0	0
Sign Control	Free	Free	Free	Free	Free	Free	Stop	Stop	Stop	Stop	Stop	Stop
RT Channelized	-	-	None	-	-	None	-	-	None	-	-	None
Storage Length	-	-	-	-	-	-	-	-	-	-	-	-
Veh in Median Storage, #	-	0	-	-	0	-	-	0	-	-	0	-
Grade, %	-	0	-	-	0	-	-	0	-	-	0	-
Peak Hour Factor	91	91	91	91	91	91	91	91	91	91	91	91
Heavy Vehicles, %	8	2	2	2	3	2	2	2	2	2	2	2
Mvmt Flow	13	140	0	0	70	9	0	1	1	12	1	12

Major/Minor	Major1			Major2			Minor1			Minor2		
Conflicting Flow All	79	0	0	140	0	0	247	245	140	242	241	75
Stage 1	-	-	-	-	-	-	166	166	-	75	75	-
Stage 2	-	-	-	-	-	-	81	79	-	167	166	-
Critical Hdwy	4.18	-	-	4.12	-	-	7.12	6.52	6.22	7.12	6.52	6.22
Critical Hdwy Stg 1	-	-	-	-	-	-	6.12	5.52	-	6.12	5.52	-
Critical Hdwy Stg 2	-	-	-	-	-	-	6.12	5.52	-	6.12	5.52	-
Follow-up Hdwy	2.272	-	-	2.218	-	-	3.518	4.018	3.318	3.518	4.018	3.318
Pot Cap-1 Maneuver	1482	-	-	1443	-	-	707	657	908	712	660	986
Stage 1	-	-	-	-	-	-	836	761	-	934	833	-
Stage 2	-	-	-	-	-	-	927	829	-	835	761	-
Platoon blocked, %		-	-		-	-						
Mov Cap-1 Maneuver	1482	-	-	1443	-	-	692	650	908	705	653	986
Mov Cap-2 Maneuver	-	-	-	-	-	-	692	650	-	705	653	-
Stage 1	-	-	-	-	-	-	828	753	-	925	833	-
Stage 2	-	-	-	-	-	-	914	829	-	824	753	-

Approach	EB	WB	NB	SB
HCM Control Delay, s	0.6	0	9.8	9.6
HCM LOS			A	A

Minor Lane/Major Mvmt	NBLn1	EBL	EBT	EBR	WBL	WBT	WBR	SBLn1
Capacity (veh/h)	758	1482	-	-	1443	-	-	813
HCM Lane V/C Ratio	0.003	0.009	-	-	-	-	-	0.031
HCM Control Delay (s)	9.8	7.5	0	-	0	-	-	9.6
HCM Lane LOS	A	A	A	-	A	-	-	A
HCM 95th %tile Q(veh)	0	0	-	-	0	-	-	0.1

Intersection						
Int Delay, s/veh	0					
Movement	EBT	EBR	WBL	WBT	NBL	NBR
Lane Configurations						
Traffic Vol, veh/h	143	0	0	80	0	0
Future Vol, veh/h	143	0	0	80	0	0
Conflicting Peds, #/hr	0	0	0	0	0	0
Sign Control	Free	Free	Free	Free	Stop	Stop
RT Channelized	-	None	-	None	-	None
Storage Length	-	-	-	-	0	-
Veh in Median Storage, #	0	-	-	0	0	-
Grade, %	0	-	-	0	0	-
Peak Hour Factor	92	92	92	92	92	92
Heavy Vehicles, %	2	2	2	2	2	2
Mvmt Flow	155	0	0	87	0	0
Major/Minor	Major1	Major2	Minor1			
Conflicting Flow All	0	0	155	0	242	155
Stage 1	-	-	-	-	155	-
Stage 2	-	-	-	-	87	-
Critical Hdwy	-	-	4.12	-	6.42	6.22
Critical Hdwy Stg 1	-	-	-	-	5.42	-
Critical Hdwy Stg 2	-	-	-	-	5.42	-
Follow-up Hdwy	-	-	2.218	-	3.518	3.318
Pot Cap-1 Maneuver	-	-	1425	-	746	891
Stage 1	-	-	-	-	873	-
Stage 2	-	-	-	-	936	-
Platoon blocked, %	-	-	-	-	-	-
Mov Cap-1 Maneuver	-	-	1425	-	746	891
Mov Cap-2 Maneuver	-	-	-	-	746	-
Stage 1	-	-	-	-	873	-
Stage 2	-	-	-	-	936	-
Approach	EB	WB	NB			
HCM Control Delay, s	0	0	0			
HCM LOS					A	
Minor Lane/Major Mvmt	NBLn1	EBT	EBR	WBL	WBT	
Capacity (veh/h)	-	-	-	1425	-	
HCM Lane V/C Ratio	-	-	-	-	-	
HCM Control Delay (s)	0	-	-	0	-	
HCM Lane LOS	A	-	-	A	-	
HCM 95th %tile Q(veh)	-	-	-	0	-	

Intersection						
Int Delay, s/veh	2.9					
Movement	EBL	EBR	NBL	NBT	SBT	SBR
Lane Configurations	T			L		T
Traffic Vol, veh/h	31	107	57	293	481	21
Future Vol, veh/h	31	107	57	293	481	21
Conflicting Peds, #/hr	0	0	0	0	0	0
Sign Control	Stop	Stop	Free	Free	Free	Free
RT Channelized	-	None	-	None	-	None
Storage Length	0	-	-	-	-	-
Veh in Median Storage, #	0	-	-	0	0	-
Grade, %	0	-	-	0	0	-
Peak Hour Factor	92	92	92	92	92	92
Heavy Vehicles, %	2	2	2	2	2	5
Mvmt Flow	34	116	62	318	523	23

Major/Minor	Minor2	Major1	Major2			
Conflicting Flow All	977	535	546	0	-	0
Stage 1	535	-	-	-	-	-
Stage 2	442	-	-	-	-	-
Critical Hdwy	6.42	6.22	4.12	-	-	-
Critical Hdwy Stg 1	5.42	-	-	-	-	-
Critical Hdwy Stg 2	5.42	-	-	-	-	-
Follow-up Hdwy	3.518	3.318	2.218	-	-	-
Pot Cap-1 Maneuver	278	545	1023	-	-	-
Stage 1	587	-	-	-	-	-
Stage 2	648	-	-	-	-	-
Platoon blocked, %				-	-	-
Mov Cap-1 Maneuver	257	545	1023	-	-	-
Mov Cap-2 Maneuver	257	-	-	-	-	-
Stage 1	544	-	-	-	-	-
Stage 2	648	-	-	-	-	-

Approach	EB	NB	SB
HCM Control Delay, s	17.6	1.4	0
HCM LOS	C		

Minor Lane/Major Mvmt	NBL	NBT	EBLn1	SBT	SBR
Capacity (veh/h)	1023	-	435	-	-
HCM Lane V/C Ratio	0.061	-	0.345	-	-
HCM Control Delay (s)	8.7	0	17.6	-	-
HCM Lane LOS	A	A	C	-	-
HCM 95th %tile Q(veh)	0.2	-	1.5	-	-

Intersection						
Int Delay, s/veh	0.3					
Movement	EBL	EBR	NBL	NBT	SBT	SBR
Lane Configurations	T		T		T	
Traffic Vol, veh/h	3	9	10	342	582	2
Future Vol, veh/h	3	9	10	342	582	2
Conflicting Peds, #/hr	0	0	0	0	0	0
Sign Control	Stop	Stop	Free	Free	Free	Free
RT Channelized	-	None	-	None	-	None
Storage Length	0	-	-	-	-	-
Veh in Median Storage, #	0	-	-	0	0	-
Grade, %	0	-	-	0	0	-
Peak Hour Factor	89	89	89	89	89	89
Heavy Vehicles, %	2	2	2	2	2	2
Mvmt Flow	3	10	11	384	654	2

Major/Minor	Minor2	Major1	Major2			
Conflicting Flow All	1061	655	656	0	-	0
Stage 1	655	-	-	-	-	-
Stage 2	406	-	-	-	-	-
Critical Hdwy	6.42	6.22	4.12	-	-	-
Critical Hdwy Stg 1	5.42	-	-	-	-	-
Critical Hdwy Stg 2	5.42	-	-	-	-	-
Follow-up Hdwy	3.518	3.318	2.218	-	-	-
Pot Cap-1 Maneuver	248	466	931	-	-	-
Stage 1	517	-	-	-	-	-
Stage 2	673	-	-	-	-	-
Platoon blocked, %				-	-	-
Mov Cap-1 Maneuver	244	466	931	-	-	-
Mov Cap-2 Maneuver	244	-	-	-	-	-
Stage 1	509	-	-	-	-	-
Stage 2	673	-	-	-	-	-

Approach	EB	NB	SB
HCM Control Delay, s	14.8	0.3	0
HCM LOS	B		

Minor Lane/Major Mvmt	NBL	NBT	EBLn1	SBT	SBR
Capacity (veh/h)	931	-	380	-	-
HCM Lane V/C Ratio	0.012	-	0.035	-	-
HCM Control Delay (s)	8.9	0	14.8	-	-
HCM Lane LOS	A	A	B	-	-
HCM 95th %tile Q(veh)	0	-	0.1	-	-

HCM 6th Signalized Intersection Summary
5: Rays Rd & Memorial Dr

Spivey Lake Residential
Existing PM



Movement	EBU	EBL	EBT	EBR	WBU	WBL	WBT	WBR	NBL	NBT	NBR	SBL
Lane Configurations		⇌	⇌	⇌		⇌	⇌	⇌	⇌	⇌		⇌
Traffic Volume (veh/h)	9	177	1254	67	13	36	1058	121	56	76	38	160
Future Volume (veh/h)	9	177	1254	67	13	36	1058	121	56	76	38	160
Initial Q (Qb), veh		0	0	0		0	0	0	0	0	0	0
Ped-Bike Adj(A_pbT)		1.00		1.00		1.00		1.00	1.00		1.00	1.00
Parking Bus, Adj		1.00	1.00	1.00		1.00	1.00	1.00	1.00	1.00	1.00	1.00
Work Zone On Approach			No				No			No		
Adj Sat Flow, veh/h/ln		1870	1870	1870		1870	1870	1870	1870	1870	1870	1870
Adj Flow Rate, veh/h		186	1320	0		38	1114	0	59	80	40	168
Peak Hour Factor		0.95	0.95	0.95		0.95	0.95	0.95	0.95	0.95	0.95	0.95
Percent Heavy Veh, %		2	2	2		2	2	2	2	2	2	2
Cap, veh/h		263	1825			115	1605		407	673	316	243
Arrive On Green		0.08	0.36	0.00		0.03	0.31	0.00	0.04	0.29	0.29	0.07
Sat Flow, veh/h		3456	5106	1585		3456	5106	1585	1781	2348	1101	3456
Grp Volume(v), veh/h		186	1320	0		38	1114	0	59	59	61	168
Grp Sat Flow(s),veh/h/ln		1728	1702	1585		1728	1702	1585	1781	1777	1672	1728
Q Serve(g_s), s		5.0	21.3	0.0		1.0	18.2	0.0	2.2	2.3	2.6	4.5
Cycle Q Clear(g_c), s		5.0	21.3	0.0		1.0	18.2	0.0	2.2	2.3	2.6	4.5
Prop In Lane		1.00		1.00		1.00		1.00	1.00		0.66	1.00
Lane Grp Cap(c), veh/h		263	1825			115	1605		407	509	479	243
V/C Ratio(X)		0.71	0.72			0.33	0.69		0.15	0.12	0.13	0.69
Avail Cap(c_a), veh/h		509	2953			182	2470		445	509	479	472
HCM Platoon Ratio		1.00	1.00	1.00		1.00	1.00	1.00	1.00	1.00	1.00	1.00
Upstream Filter(l)		1.00	1.00	0.00		1.00	1.00	0.00	1.00	1.00	1.00	1.00
Uniform Delay (d), s/veh		42.9	26.5	0.0		44.9	28.6	0.0	22.2	25.0	25.1	43.2
Incr Delay (d2), s/veh		3.5	0.6	0.0		1.7	0.5	0.0	0.2	0.5	0.5	3.5
Initial Q Delay(d3),s/veh		0.0	0.0	0.0		0.0	0.0	0.0	0.0	0.0	0.0	0.0
%ile BackOfQ(50%),veh/ln		2.2	8.1	0.0		0.4	7.0	0.0	0.9	1.0	1.1	2.0
Unsig. Movement Delay, s/veh												
LnGrp Delay(d),s/veh		46.3	27.0	0.0		46.6	29.1	0.0	22.4	25.5	25.7	46.7
LnGrp LOS		D	C			D	C		C	C	C	D
Approach Vol, veh/h			1506	A			1152	A		179		
Approach Delay, s/veh			29.4				29.7			24.5		
Approach LOS			C				C			C		
Timer - Assigned Phs	1	2	3	4	5	6	7	8				
Phs Duration (G+Y+Rc), s	13.2	35.9	9.9	36.0	9.2	40.0	12.7	33.3				
Change Period (Y+Rc), s	6.0	6.0	6.0	6.0	6.0	6.0	6.0	6.0				
Max Green Setting (Gmax), s	14.0	46.0	6.0	30.0	5.0	55.0	13.0	23.0				
Max Q Clear Time (g_c+I1), s	7.0	20.2	4.2	17.2	3.0	23.3	6.5	4.6				
Green Ext Time (p_c), s	0.3	8.0	0.0	1.7	0.0	10.7	0.3	0.5				

Intersection Summary

HCM 6th Ctrl Delay	30.1
HCM 6th LOS	C

Notes

User approved ignoring U-Turning movement.
Unsignalized Delay for [EBR, WBR] is excluded from calculations of the approach delay and intersection delay.

HCM 6th Signalized Intersection Summary
 5: Rays Rd & Memorial Dr

Spivey Lake Residential
 Existing PM



Movement	SBT	SBR
Lane Configurations	↑↑	↑
Traffic Volume (veh/h)	167	285
Future Volume (veh/h)	167	285
Initial Q (Qb), veh	0	0
Ped-Bike Adj(A_pbT)		1.00
Parking Bus, Adj	1.00	1.00
Work Zone On Approach	No	
Adj Sat Flow, veh/h/ln	1870	1870
Adj Flow Rate, veh/h	176	300
Peak Hour Factor	0.95	0.95
Percent Heavy Veh, %	2	2
Cap, veh/h	1121	500
Arrive On Green	0.32	0.32
Sat Flow, veh/h	3554	1585
Grp Volume(v), veh/h	176	300
Grp Sat Flow(s),veh/h/ln	1777	1585
Q Serve(g_s), s	3.4	15.2
Cycle Q Clear(g_c), s	3.4	15.2
Prop In Lane		1.00
Lane Grp Cap(c), veh/h	1121	500
V/C Ratio(X)	0.16	0.60
Avail Cap(c_a), veh/h	1121	500
HCM Platoon Ratio	1.00	1.00
Upstream Filter(l)	1.00	1.00
Uniform Delay (d), s/veh	23.4	27.5
Incr Delay (d2), s/veh	0.3	5.2
Initial Q Delay(d3),s/veh	0.0	0.0
%ile BackOfQ(50%),veh/ln	1.4	6.3
Unsig. Movement Delay, s/veh		
LnGrp Delay(d),s/veh	23.7	32.7
LnGrp LOS	C	C
Approach Vol, veh/h	644	
Approach Delay, s/veh	33.9	
Approach LOS	C	
Timer - Assigned Phs		

Intersection												
Int Delay, s/veh	4.6											
Movement	EBL	EBT	EBR	WBL	WBT	WBR	NBL	NBT	NBR	SBL	SBT	SBR
Lane Configurations		↕			↕			↕			↕	
Traffic Vol, veh/h	27	49	0	0	71	24	0	0	1	31	0	73
Future Vol, veh/h	27	49	0	0	71	24	0	0	1	31	0	73
Conflicting Peds, #/hr	0	0	0	0	0	0	0	0	0	0	0	0
Sign Control	Free	Free	Free	Free	Free	Free	Stop	Stop	Stop	Stop	Stop	Stop
RT Channelized	-	-	None	-	-	None	-	-	None	-	-	None
Storage Length	-	-	-	-	-	-	-	-	-	-	-	-
Veh in Median Storage, #	-	0	-	-	0	-	-	0	-	-	0	-
Grade, %	-	0	-	-	0	-	-	0	-	-	0	-
Peak Hour Factor	79	79	79	79	79	79	79	79	79	79	79	79
Heavy Vehicles, %	2	9	2	2	12	6	2	2	2	23	2	14
Mvmt Flow	34	62	0	0	90	30	0	0	1	39	0	92

Major/Minor	Major1		Major2		Minor1		Minor2					
Conflicting Flow All	120	0	0	62	0	0	281	250	62	236	235	105
Stage 1	-	-	-	-	-	-	130	130	-	105	105	-
Stage 2	-	-	-	-	-	-	151	120	-	131	130	-
Critical Hdwy	4.12	-	-	4.12	-	-	7.12	6.52	6.22	7.33	6.52	6.34
Critical Hdwy Stg 1	-	-	-	-	-	-	6.12	5.52	-	6.33	5.52	-
Critical Hdwy Stg 2	-	-	-	-	-	-	6.12	5.52	-	6.33	5.52	-
Follow-up Hdwy	2.218	-	-	2.218	-	-	3.518	4.018	3.318	3.707	4.018	3.426
Pot Cap-1 Maneuver	1468	-	-	1541	-	-	671	653	1003	677	666	918
Stage 1	-	-	-	-	-	-	874	789	-	852	808	-
Stage 2	-	-	-	-	-	-	851	796	-	825	789	-
Platoon blocked, %		-	-		-	-						
Mov Cap-1 Maneuver	1468	-	-	1541	-	-	592	637	1003	663	650	918
Mov Cap-2 Maneuver	-	-	-	-	-	-	592	637	-	663	650	-
Stage 1	-	-	-	-	-	-	853	770	-	832	808	-
Stage 2	-	-	-	-	-	-	765	796	-	804	770	-

Approach	EB	WB	NB	SB
HCM Control Delay, s	2.7	0	8.6	10.2
HCM LOS			A	B

Minor Lane/Major Mvmt	NBLn1	EBL	EBT	EBR	WBL	WBT	WBR	SBLn1
Capacity (veh/h)	1003	1468	-	-	1541	-	-	824
HCM Lane V/C Ratio	0.001	0.023	-	-	-	-	-	0.16
HCM Control Delay (s)	8.6	7.5	0	-	0	-	-	10.2
HCM Lane LOS	A	A	A	-	A	-	-	B
HCM 95th %tile Q(veh)	0	0.1	-	-	0	-	-	0.6

Intersection						
Int Delay, s/veh	0					
Movement	EBT	EBR	WBL	WBT	NBL	NBR
Lane Configurations						
Traffic Vol, veh/h	83	0	0	98	0	0
Future Vol, veh/h	83	0	0	98	0	0
Conflicting Peds, #/hr	0	0	0	0	0	0
Sign Control	Free	Free	Free	Free	Stop	Stop
RT Channelized	-	None	-	None	-	None
Storage Length	-	-	-	-	0	-
Veh in Median Storage, #	0	-	-	0	0	-
Grade, %	0	-	-	0	0	-
Peak Hour Factor	92	92	92	92	92	92
Heavy Vehicles, %	2	2	2	2	2	2
Mvmt Flow	90	0	0	107	0	0
Major/Minor	Major1	Major2	Minor1			
Conflicting Flow All	0	0	90	0	197	90
Stage 1	-	-	-	-	90	-
Stage 2	-	-	-	-	107	-
Critical Hdwy	-	-	4.12	-	6.42	6.22
Critical Hdwy Stg 1	-	-	-	-	5.42	-
Critical Hdwy Stg 2	-	-	-	-	5.42	-
Follow-up Hdwy	-	-	2.218	-	3.518	3.318
Pot Cap-1 Maneuver	-	-	1505	-	792	968
Stage 1	-	-	-	-	934	-
Stage 2	-	-	-	-	917	-
Platoon blocked, %	-	-	-	-	-	-
Mov Cap-1 Maneuver	-	-	1505	-	792	968
Mov Cap-2 Maneuver	-	-	-	-	792	-
Stage 1	-	-	-	-	934	-
Stage 2	-	-	-	-	917	-
Approach	EB	WB	NB			
HCM Control Delay, s	0	0	0			
HCM LOS					A	
Minor Lane/Major Mvmt	NBLn1	EBT	EBR	WBL	WBT	
Capacity (veh/h)	-	-	-	1505	-	
HCM Lane V/C Ratio	-	-	-	-	-	
HCM Control Delay (s)	0	-	-	0	-	
HCM Lane LOS	A	-	-	A	-	
HCM 95th %tile Q(veh)	-	-	-	0	-	

Intersection						
Int Delay, s/veh	1.9					
Movement	EBL	EBR	NBL	NBT	SBT	SBR
Lane Configurations	T			T		T
Traffic Vol, veh/h	15	46	67	225	340	28
Future Vol, veh/h	15	46	67	225	340	28
Conflicting Peds, #/hr	0	0	0	0	0	0
Sign Control	Stop	Stop	Free	Free	Free	Free
RT Channelized	-	None	-	None	-	None
Storage Length	0	-	-	-	-	-
Veh in Median Storage, #	0	-	-	0	0	-
Grade, %	0	-	-	0	0	-
Peak Hour Factor	88	88	88	88	88	88
Heavy Vehicles, %	2	3	2	6	8	2
Mvmt Flow	17	52	76	256	386	32

Major/Minor	Minor2	Major1	Major2			
Conflicting Flow All	810	402	418	0	-	0
Stage 1	402	-	-	-	-	-
Stage 2	408	-	-	-	-	-
Critical Hdwy	6.42	6.23	4.12	-	-	-
Critical Hdwy Stg 1	5.42	-	-	-	-	-
Critical Hdwy Stg 2	5.42	-	-	-	-	-
Follow-up Hdwy	3.518	3.327	2.218	-	-	-
Pot Cap-1 Maneuver	349	646	1141	-	-	-
Stage 1	676	-	-	-	-	-
Stage 2	671	-	-	-	-	-
Platoon blocked, %				-	-	-
Mov Cap-1 Maneuver	322	646	1141	-	-	-
Mov Cap-2 Maneuver	322	-	-	-	-	-
Stage 1	623	-	-	-	-	-
Stage 2	671	-	-	-	-	-

Approach	EB	NB	SB
HCM Control Delay, s	13	1.9	0
HCM LOS	B		

Minor Lane/Major Mvmt	NBL	NBT	EBLn1	SBT	SBR
Capacity (veh/h)	1141	-	518	-	-
HCM Lane V/C Ratio	0.067	-	0.134	-	-
HCM Control Delay (s)	8.4	0	13	-	-
HCM Lane LOS	A	A	B	-	-
HCM 95th %tile Q(veh)	0.2	-	0.5	-	-

Intersection						
Int Delay, s/veh	0.1					
Movement	EBL	EBR	NBL	NBT	SBT	SBR
Lane Configurations	T			T		
Traffic Vol, veh/h	3	4	1	273	399	1
Future Vol, veh/h	3	4	1	273	399	1
Conflicting Peds, #/hr	0	0	0	0	0	0
Sign Control	Stop	Stop	Free	Free	Free	Free
RT Channelized	-	None	-	None	-	None
Storage Length	0	-	-	-	-	-
Veh in Median Storage, #	0	-	-	0	0	-
Grade, %	0	-	-	0	0	-
Peak Hour Factor	90	90	90	90	90	90
Heavy Vehicles, %	2	2	2	6	7	2
Mvmt Flow	3	4	1	303	443	1

Major/Minor	Minor2	Major1		Major2	
Conflicting Flow All	749	444	444	0	0
Stage 1	444	-	-	-	-
Stage 2	305	-	-	-	-
Critical Hdwy	6.42	6.22	4.12	-	-
Critical Hdwy Stg 1	5.42	-	-	-	-
Critical Hdwy Stg 2	5.42	-	-	-	-
Follow-up Hdwy	3.518	3.318	2.218	-	-
Pot Cap-1 Maneuver	379	614	1116	-	-
Stage 1	646	-	-	-	-
Stage 2	748	-	-	-	-
Platoon blocked, %				-	-
Mov Cap-1 Maneuver	379	614	1116	-	-
Mov Cap-2 Maneuver	379	-	-	-	-
Stage 1	645	-	-	-	-
Stage 2	748	-	-	-	-

Approach	EB	NB	SB
HCM Control Delay, s	12.5	0	0
HCM LOS	B		

Minor Lane/Major Mvmt	NBL	NBT	EBLn1	SBT	SBR
Capacity (veh/h)	1116	-	485	-	-
HCM Lane V/C Ratio	0.001	-	0.016	-	-
HCM Control Delay (s)	8.2	0	12.5	-	-
HCM Lane LOS	A	A	B	-	-
HCM 95th %tile Q(veh)	0	-	0	-	-

HCM 6th Signalized Intersection Summary
5: Rays Rd & Memorial Dr

Spivey Lake Residential
Existing AM (Baseline)



Movement	EBU	EBL	EBT	EBR	WBU	WBL	WBT	WBR	NBL	NBT	NBR	SBL
Lane Configurations		2T	3T	T		2T	3T	T	T	2T		2T
Traffic Volume (veh/h)	8	104	732	42	14	14	1186	81	50	95	18	66
Future Volume (veh/h)	8	104	732	42	14	14	1186	81	50	95	18	66
Initial Q (Qb), veh		0	0	0		0	0	0	0	0	0	0
Ped-Bike Adj(A_pbT)		1.00		1.00		1.00		1.00	1.00		1.00	1.00
Parking Bus, Adj		1.00	1.00	1.00		1.00	1.00	1.00	1.00	1.00	1.00	1.00
Work Zone On Approach			No				No			No		
Adj Sat Flow, veh/h/ln		1752	1796	1856		1752	1826	1796	1870	1870	1870	1737
Adj Flow Rate, veh/h		107	755	0		14	1223	0	52	98	19	68
Peak Hour Factor		0.97	0.97	0.97		0.97	0.97	0.97	0.97	0.97	0.97	0.97
Percent Heavy Veh, %		10	7	3		10	5	7	2	2	2	11
Cap, veh/h		168	1832			53	1685		471	917	173	143
Arrive On Green		0.05	0.37	0.00		0.02	0.34	0.00	0.04	0.31	0.31	0.04
Sat Flow, veh/h		3237	4904	1572		3237	4985	1522	1781	2982	564	3209
Grp Volume(v), veh/h		107	755	0		14	1223	0	52	57	60	68
Grp Sat Flow(s),veh/h/ln		1618	1635	1572		1618	1662	1522	1781	1777	1769	1605
Q Serve(g_s), s		3.0	10.6	0.0		0.4	20.0	0.0	1.8	2.1	2.2	1.9
Cycle Q Clear(g_c), s		3.0	10.6	0.0		0.4	20.0	0.0	1.8	2.1	2.2	1.9
Prop In Lane		1.00		1.00		1.00		1.00	1.00		0.32	1.00
Lane Grp Cap(c), veh/h		168	1832			53	1685		471	546	544	143
V/C Ratio(X)		0.64	0.41			0.27	0.73		0.11	0.11	0.11	0.48
Avail Cap(c_a), veh/h		383	2903			244	2736		496	546	544	276
HCM Platoon Ratio		1.00	1.00	1.00		1.00	1.00	1.00	1.00	1.00	1.00	1.00
Upstream Filter(l)		1.00	1.00	0.00		1.00	1.00	0.00	1.00	1.00	1.00	1.00
Uniform Delay (d), s/veh		43.2	21.6	0.0		45.1	27.0	0.0	20.4	23.0	23.1	43.3
Incr Delay (d2), s/veh		4.0	0.1	0.0		2.6	0.6	0.0	0.1	0.4	0.4	2.4
Initial Q Delay(d3),s/veh		0.0	0.0	0.0		0.0	0.0	0.0	0.0	0.0	0.0	0.0
%ile BackOfQ(50%),veh/ln		1.2	3.8	0.0		0.2	7.4	0.0	0.7	0.9	1.0	0.8
Unsig. Movement Delay, s/veh												
LnGrp Delay(d),s/veh		47.2	21.7	0.0		47.8	27.6	0.0	20.5	23.4	23.5	45.8
LnGrp LOS		D	C			D	C		C	C	C	D
Approach Vol, veh/h			862	A			1237	A		169		
Approach Delay, s/veh			24.9				27.8			22.5		
Approach LOS			C				C			C		
Timer - Assigned Phs	1	2	3	4	5	6	7	8				
Phs Duration (G+Y+Rc), s	10.8	37.4	9.7	35.0	7.5	40.7	10.1	34.6				
Change Period (Y+Rc), s	6.0	6.0	6.0	6.0	6.0	6.0	6.0	6.0				
Max Green Setting (Gmax), s	11.0	51.0	5.0	29.0	7.0	55.0	8.0	26.0				
Max Q Clear Time (g_c+I1), s	5.0	22.0	3.8	15.2	2.4	12.6	3.9	4.2				
Green Ext Time (p_c), s	0.1	9.4	0.0	1.0	0.0	5.5	0.0	0.5				

Intersection Summary

HCM 6th Ctrl Delay	27.2
HCM 6th LOS	C

Notes

User approved ignoring U-Turning movement.
Unsignalized Delay for [EBR, WBR] is excluded from calculations of the approach delay and intersection delay.

HCM 6th Signalized Intersection Summary
 5: Rays Rd & Memorial Dr

Spivey Lake Residential
 Existing AM (Baseline)



Movement	SBT	SBR
Lane Configurations	↑↑	↑
Traffic Volume (veh/h)	50	252
Future Volume (veh/h)	50	252
Initial Q (Qb), veh	0	0
Ped-Bike Adj(A_pbT)		1.00
Parking Bus, Adj	1.00	1.00
Work Zone On Approach	No	
Adj Sat Flow, veh/h/ln	1870	1796
Adj Flow Rate, veh/h	52	260
Peak Hour Factor	0.97	0.97
Percent Heavy Veh, %	2	7
Cap, veh/h	1109	475
Arrive On Green	0.31	0.31
Sat Flow, veh/h	3554	1522
Grp Volume(v), veh/h	52	260
Grp Sat Flow(s),veh/h/ln	1777	1522
Q Serve(g_s), s	0.9	13.2
Cycle Q Clear(g_c), s	0.9	13.2
Prop In Lane		1.00
Lane Grp Cap(c), veh/h	1109	475
V/C Ratio(X)	0.05	0.55
Avail Cap(c_a), veh/h	1109	475
HCM Platoon Ratio	1.00	1.00
Upstream Filter(l)	1.00	1.00
Uniform Delay (d), s/veh	22.3	26.5
Incr Delay (d2), s/veh	0.1	4.5
Initial Q Delay(d3),s/veh	0.0	0.0
%ile BackOfQ(50%),veh/ln	0.4	5.2
Unsig. Movement Delay, s/veh		
LnGrp Delay(d),s/veh	22.4	31.0
LnGrp LOS	C	C
Approach Vol, veh/h	380	
Approach Delay, s/veh	32.5	
Approach LOS	C	
Timer - Assigned Phs		

Intersection												
Int Delay, s/veh	1.5											
Movement	EBL	EBT	EBR	WBL	WBT	WBR	NBL	NBT	NBR	SBL	SBT	SBR
Lane Configurations		↕			↕			↕			↕	
Traffic Vol, veh/h	13	133	0	0	67	8	0	1	1	12	1	12
Future Vol, veh/h	13	133	0	0	67	8	0	1	1	12	1	12
Conflicting Peds, #/hr	0	0	0	0	0	0	0	0	0	0	0	0
Sign Control	Free	Free	Free	Free	Free	Free	Stop	Stop	Stop	Stop	Stop	Stop
RT Channelized	-	-	None	-	-	None	-	-	None	-	-	None
Storage Length	-	-	-	-	-	-	-	-	-	-	-	-
Veh in Median Storage, #	-	0	-	-	0	-	-	0	-	-	0	-
Grade, %	-	0	-	-	0	-	-	0	-	-	0	-
Peak Hour Factor	91	91	91	91	91	91	91	91	91	91	91	91
Heavy Vehicles, %	8	2	2	2	3	2	2	2	2	2	2	2
Mvmt Flow	14	146	0	0	74	9	0	1	1	13	1	13

Major/Minor	Major1		Major2		Minor1		Minor2					
Conflicting Flow All	83	0	0	146	0	0	260	257	146	254	253	79
Stage 1	-	-	-	-	-	-	174	174	-	79	79	-
Stage 2	-	-	-	-	-	-	86	83	-	175	174	-
Critical Hdwy	4.18	-	-	4.12	-	-	7.12	6.52	6.22	7.12	6.52	6.22
Critical Hdwy Stg 1	-	-	-	-	-	-	6.12	5.52	-	6.12	5.52	-
Critical Hdwy Stg 2	-	-	-	-	-	-	6.12	5.52	-	6.12	5.52	-
Follow-up Hdwy	2.272	-	-	2.218	-	-	3.518	4.018	3.318	3.518	4.018	3.318
Pot Cap-1 Maneuver	1477	-	-	1436	-	-	693	647	901	699	650	981
Stage 1	-	-	-	-	-	-	828	755	-	930	829	-
Stage 2	-	-	-	-	-	-	922	826	-	827	755	-
Platoon blocked, %	-	-	-	-	-	-	-	-	-	-	-	-
Mov Cap-1 Maneuver	1477	-	-	1436	-	-	678	641	901	692	644	981
Mov Cap-2 Maneuver	-	-	-	-	-	-	678	641	-	692	644	-
Stage 1	-	-	-	-	-	-	820	747	-	921	829	-
Stage 2	-	-	-	-	-	-	908	826	-	817	747	-

Approach	EB	WB	NB	SB
HCM Control Delay, s	0.7	0	9.8	9.6
HCM LOS			A	A

Minor Lane/Major Mvmt	NBLn1	EBL	EBT	EBR	WBL	WBT	WBR	SBLn1
Capacity (veh/h)	749	1477	-	-	1436	-	-	803
HCM Lane V/C Ratio	0.003	0.01	-	-	-	-	-	0.034
HCM Control Delay (s)	9.8	7.5	0	-	0	-	-	9.6
HCM Lane LOS	A	A	A	-	A	-	-	A
HCM 95th %tile Q(veh)	0	0	-	-	0	-	-	0.1

Intersection						
Int Delay, s/veh	0					
Movement	EBT	EBR	WBL	WBT	NBL	NBR
Lane Configurations						
Traffic Vol, veh/h	150	0	0	84	0	0
Future Vol, veh/h	150	0	0	84	0	0
Conflicting Peds, #/hr	0	0	0	0	0	0
Sign Control	Free	Free	Free	Free	Stop	Stop
RT Channelized	-	None	-	None	-	None
Storage Length	-	-	-	-	0	-
Veh in Median Storage, #	0	-	-	0	0	-
Grade, %	0	-	-	0	0	-
Peak Hour Factor	92	92	92	92	92	92
Heavy Vehicles, %	2	2	2	2	2	2
Mvmt Flow	163	0	0	91	0	0

Major/Minor	Major1	Major2	Minor1	Minor2	Minor3
Conflicting Flow All	0	0	163	0	254
Stage 1	-	-	-	-	163
Stage 2	-	-	-	-	91
Critical Hdwy	-	-	4.12	-	6.42
Critical Hdwy Stg 1	-	-	-	-	5.42
Critical Hdwy Stg 2	-	-	-	-	5.42
Follow-up Hdwy	-	-	2.218	-	3.518
Pot Cap-1 Maneuver	-	-	1416	-	735
Stage 1	-	-	-	-	866
Stage 2	-	-	-	-	933
Platoon blocked, %	-	-	-	-	-
Mov Cap-1 Maneuver	-	-	1416	-	735
Mov Cap-2 Maneuver	-	-	-	-	735
Stage 1	-	-	-	-	866
Stage 2	-	-	-	-	933

Approach	EB	WB	NB
HCM Control Delay, s	0	0	0
HCM LOS			A

Minor Lane/Major Mvmt	NBLn1	EBT	EBR	WBL	WBT
Capacity (veh/h)	-	-	-	1416	-
HCM Lane V/C Ratio	-	-	-	-	-
HCM Control Delay (s)	0	-	-	0	-
HCM Lane LOS	A	-	-	A	-
HCM 95th %tile Q(veh)	-	-	-	0	-

Intersection						
Int Delay, s/veh	3.1					
Movement	EBL	EBR	NBL	NBT	SBT	SBR
Lane Configurations	T			T		
Traffic Vol, veh/h	33	112	60	308	505	22
Future Vol, veh/h	33	112	60	308	505	22
Conflicting Peds, #/hr	0	0	0	0	0	0
Sign Control	Stop	Stop	Free	Free	Free	Free
RT Channelized	-	None	-	None	-	None
Storage Length	0	-	-	-	-	-
Veh in Median Storage, #	0	-	-	0	0	-
Grade, %	0	-	-	0	0	-
Peak Hour Factor	92	92	92	92	92	92
Heavy Vehicles, %	2	2	2	2	2	5
Mvmt Flow	36	122	65	335	549	24

Major/Minor	Minor2	Major1	Major2			
Conflicting Flow All	1026	561	573	0	-	0
Stage 1	561	-	-	-	-	-
Stage 2	465	-	-	-	-	-
Critical Hdwy	6.42	6.22	4.12	-	-	-
Critical Hdwy Stg 1	5.42	-	-	-	-	-
Critical Hdwy Stg 2	5.42	-	-	-	-	-
Follow-up Hdwy	3.518	3.318	2.218	-	-	-
Pot Cap-1 Maneuver	260	527	1000	-	-	-
Stage 1	571	-	-	-	-	-
Stage 2	632	-	-	-	-	-
Platoon blocked, %				-	-	-
Mov Cap-1 Maneuver	239	527	1000	-	-	-
Mov Cap-2 Maneuver	239	-	-	-	-	-
Stage 1	525	-	-	-	-	-
Stage 2	632	-	-	-	-	-

Approach	EB	NB	SB
HCM Control Delay, s	18.9	1.4	0
HCM LOS	C		

Minor Lane/Major Mvmt	NBL	NBT	EBLn1	SBT	SBR
Capacity (veh/h)	1000	-	414	-	-
HCM Lane V/C Ratio	0.065	-	0.381	-	-
HCM Control Delay (s)	8.9	0	18.9	-	-
HCM Lane LOS	A	A	C	-	-
HCM 95th %tile Q(veh)	0.2	-	1.7	-	-

Intersection						
Int Delay, s/veh	0.3					
Movement	EBL	EBR	NBL	NBT	SBT	SBR
Lane Configurations	T			T		T
Traffic Vol, veh/h	3	9	11	359	611	2
Future Vol, veh/h	3	9	11	359	611	2
Conflicting Peds, #/hr	0	0	0	0	0	0
Sign Control	Stop	Stop	Free	Free	Free	Free
RT Channelized	-	None	-	None	-	None
Storage Length	0	-	-	-	-	-
Veh in Median Storage, #	0	-	-	0	0	-
Grade, %	0	-	-	0	0	-
Peak Hour Factor	89	89	89	89	89	89
Heavy Vehicles, %	2	2	2	2	2	2
Mvmt Flow	3	10	12	403	687	2

Major/Minor	Minor2	Major1	Major2			
Conflicting Flow All	1115	688	689	0	-	0
Stage 1	688	-	-	-	-	-
Stage 2	427	-	-	-	-	-
Critical Hdwy	6.42	6.22	4.12	-	-	-
Critical Hdwy Stg 1	5.42	-	-	-	-	-
Critical Hdwy Stg 2	5.42	-	-	-	-	-
Follow-up Hdwy	3.518	3.318	2.218	-	-	-
Pot Cap-1 Maneuver	230	446	905	-	-	-
Stage 1	499	-	-	-	-	-
Stage 2	658	-	-	-	-	-
Platoon blocked, %				-	-	-
Mov Cap-1 Maneuver	226	446	905	-	-	-
Mov Cap-2 Maneuver	226	-	-	-	-	-
Stage 1	491	-	-	-	-	-
Stage 2	658	-	-	-	-	-

Approach	EB	NB	SB
HCM Control Delay, s	15.4	0.3	0
HCM LOS	C		

Minor Lane/Major Mvmt	NBL	NBT	EBLn1	SBT	SBR
Capacity (veh/h)	905	-	359	-	-
HCM Lane V/C Ratio	0.014	-	0.038	-	-
HCM Control Delay (s)	9	0	15.4	-	-
HCM Lane LOS	A	A	C	-	-
HCM 95th %tile Q(veh)	0	-	0.1	-	-

HCM 6th Signalized Intersection Summary
5: Rays Rd & Memorial Dr

Spivey Lake Residential
Existing PM (Baseline)



Movement	EBU	EBL	EBT	EBR	WBU	WBL	WBT	WBR	NBL	NBT	NBR	SBL
Lane Configurations		↔↔	↑↑↑	↗		↔↔	↑↑↑	↗	↖	↑↑		↖↖
Traffic Volume (veh/h)	9	186	1317	70	14	38	1111	127	59	80	40	168
Future Volume (veh/h)	9	186	1317	70	14	38	1111	127	59	80	40	168
Initial Q (Qb), veh		0	0	0		0	0	0	0	0	0	0
Ped-Bike Adj(A_pbT)		1.00		1.00		1.00		1.00	1.00		1.00	1.00
Parking Bus, Adj		1.00	1.00	1.00		1.00	1.00	1.00	1.00	1.00	1.00	1.00
Work Zone On Approach			No				No			No		
Adj Sat Flow, veh/h/ln		1870	1870	1870		1870	1870	1870	1870	1870	1870	1870
Adj Flow Rate, veh/h		196	1386	0		40	1169	0	62	84	42	177
Peak Hour Factor		0.95	0.95	0.95		0.95	0.95	0.95	0.95	0.95	0.95	0.95
Percent Heavy Veh, %		2	2	2		2	2	2	2	2	2	2
Cap, veh/h		271	1872			117	1643		396	666	313	250
Arrive On Green		0.08	0.37	0.00		0.03	0.32	0.00	0.04	0.28	0.28	0.07
Sat Flow, veh/h		3456	5106	1585		3456	5106	1585	1781	2347	1102	3456
Grp Volume(v), veh/h		196	1386	0		40	1169	0	62	62	64	177
Grp Sat Flow(s),veh/h/ln		1728	1702	1585		1728	1702	1585	1781	1777	1672	1728
Q Serve(g_s), s		5.5	23.3	0.0		1.1	19.8	0.0	2.4	2.6	2.8	4.9
Cycle Q Clear(g_c), s		5.5	23.3	0.0		1.1	19.8	0.0	2.4	2.6	2.8	4.9
Prop In Lane		1.00		1.00		1.00		1.00	1.00		0.66	1.00
Lane Grp Cap(c), veh/h		271	1872			117	1643		396	504	474	250
V/C Ratio(X)		0.72	0.74			0.34	0.71		0.16	0.12	0.13	0.71
Avail Cap(c_a), veh/h		491	2747			210	2332		431	504	474	456
HCM Platoon Ratio		1.00	1.00	1.00		1.00	1.00	1.00	1.00	1.00	1.00	1.00
Upstream Filter(l)		1.00	1.00	0.00		1.00	1.00	0.00	1.00	1.00	1.00	1.00
Uniform Delay (d), s/veh		44.3	27.1	0.0		46.5	29.4	0.0	23.2	26.2	26.3	44.7
Incr Delay (d2), s/veh		3.6	0.6	0.0		1.7	0.6	0.0	0.2	0.5	0.6	3.6
Initial Q Delay(d3),s/veh		0.0	0.0	0.0		0.0	0.0	0.0	0.0	0.0	0.0	0.0
%ile BackOfQ(50%),veh/ln		2.4	8.8	0.0		0.5	7.7	0.0	1.0	1.1	1.2	2.2
Unsig. Movement Delay, s/veh												
LnGrp Delay(d),s/veh		48.0	27.7	0.0		48.3	30.0	0.0	23.4	26.7	26.9	48.3
LnGrp LOS		D	C			D	C		C	C	C	D
Approach Vol, veh/h			1582	A			1209	A		188		
Approach Delay, s/veh			30.2				30.6			25.7		
Approach LOS			C				C			C		
Timer - Assigned Phs	1	2	3	4	5	6	7	8				
Phs Duration (G+Y+Rc), s	13.7	37.7	10.1	37.0	9.3	42.1	13.1	33.9				
Change Period (Y+Rc), s	6.0	6.0	6.0	6.0	6.0	6.0	6.0	6.0				
Max Green Setting (Gmax), s	14.0	45.0	6.0	31.0	6.0	53.0	13.0	24.0				
Max Q Clear Time (g_c+I1), s	7.5	21.8	4.4	18.7	3.1	25.3	6.9	4.8				
Green Ext Time (p_c), s	0.3	8.2	0.0	1.8	0.0	10.9	0.3	0.6				

Intersection Summary

HCM 6th Ctrl Delay	31.1
HCM 6th LOS	C

Notes

User approved ignoring U-Turning movement.

Unsignalized Delay for [EBR, WBR] is excluded from calculations of the approach delay and intersection delay.

HCM 6th Signalized Intersection Summary
 5: Rays Rd & Memorial Dr

Spivey Lake Residential
 Existing PM (Baseline)



Movement	SBT	SBR
Lane Configurations	↑↑	↑
Traffic Volume (veh/h)	175	299
Future Volume (veh/h)	175	299
Initial Q (Qb), veh	0	0
Ped-Bike Adj(A_pbT)		1.00
Parking Bus, Adj	1.00	1.00
Work Zone On Approach	No	
Adj Sat Flow, veh/h/ln	1870	1870
Adj Flow Rate, veh/h	184	315
Peak Hour Factor	0.95	0.95
Percent Heavy Veh, %	2	2
Cap, veh/h	1118	499
Arrive On Green	0.31	0.31
Sat Flow, veh/h	3554	1585
Grp Volume(v), veh/h	184	315
Grp Sat Flow(s),veh/h/ln	1777	1585
Q Serve(g_s), s	3.7	16.7
Cycle Q Clear(g_c), s	3.7	16.7
Prop In Lane		1.00
Lane Grp Cap(c), veh/h	1118	499
V/C Ratio(X)	0.16	0.63
Avail Cap(c_a), veh/h	1118	499
HCM Platoon Ratio	1.00	1.00
Upstream Filter(l)	1.00	1.00
Uniform Delay (d), s/veh	24.4	28.9
Incr Delay (d2), s/veh	0.3	6.0
Initial Q Delay(d3),s/veh	0.0	0.0
%ile BackOfQ(50%),veh/ln	1.6	7.0
Unsig. Movement Delay, s/veh		
LnGrp Delay(d),s/veh	24.7	34.8
LnGrp LOS	C	C
Approach Vol, veh/h	676	
Approach Delay, s/veh	35.6	
Approach LOS	D	
Timer - Assigned Phs		

Intersection												
Int Delay, s/veh	4.7											
Movement	EBL	EBT	EBR	WBL	WBT	WBR	NBL	NBT	NBR	SBL	SBT	SBR
Lane Configurations		↕			↕			↕			↕	
Traffic Vol, veh/h	30	54	0	0	78	27	0	0	1	34	0	81
Future Vol, veh/h	30	54	0	0	78	27	0	0	1	34	0	81
Conflicting Peds, #/hr	0	0	0	0	0	0	0	0	0	0	0	0
Sign Control	Free	Free	Free	Free	Free	Free	Stop	Stop	Stop	Stop	Stop	Stop
RT Channelized	-	-	None	-	-	None	-	-	None	-	-	None
Storage Length	-	-	-	-	-	-	-	-	-	-	-	-
Veh in Median Storage, #	-	0	-	-	0	-	-	0	-	-	0	-
Grade, %	-	0	-	-	0	-	-	0	-	-	0	-
Peak Hour Factor	79	79	79	79	79	79	79	79	79	79	79	79
Heavy Vehicles, %	2	9	2	2	12	6	2	2	2	23	2	14
Mvmt Flow	38	68	0	0	99	34	0	0	1	43	0	103

Major/Minor	Major1		Major2		Minor1			Minor2				
Conflicting Flow All	133	0	0	68	0	0	312	277	68	261	260	116
Stage 1	-	-	-	-	-	-	144	144	-	116	116	-
Stage 2	-	-	-	-	-	-	168	133	-	145	144	-
Critical Hdwy	4.12	-	-	4.12	-	-	7.12	6.52	6.22	7.33	6.52	6.34
Critical Hdwy Stg 1	-	-	-	-	-	-	6.12	5.52	-	6.33	5.52	-
Critical Hdwy Stg 2	-	-	-	-	-	-	6.12	5.52	-	6.33	5.52	-
Follow-up Hdwy	2.218	-	-	2.218	-	-	3.518	4.018	3.318	3.707	4.018	3.426
Pot Cap-1 Maneuver	1452	-	-	1533	-	-	641	631	995	651	645	905
Stage 1	-	-	-	-	-	-	859	778	-	840	800	-
Stage 2	-	-	-	-	-	-	834	786	-	810	778	-
Platoon blocked, %	-	-	-	-	-	-	-	-	-	-	-	-
Mov Cap-1 Maneuver	1452	-	-	1533	-	-	556	614	995	637	628	905
Mov Cap-2 Maneuver	-	-	-	-	-	-	556	614	-	637	628	-
Stage 1	-	-	-	-	-	-	836	757	-	817	800	-
Stage 2	-	-	-	-	-	-	740	786	-	787	757	-

Approach	EB		WB		NB		SB	
HCM Control Delay, s	2.7		0		8.6		10.5	
HCM LOS					A		B	

Minor Lane/Major Mvmt	NBLn1	EBL	EBT	EBR	WBL	WBT	WBR	SBLn1
Capacity (veh/h)	995	1452	-	-	1533	-	-	805
HCM Lane V/C Ratio	0.001	0.026	-	-	-	-	-	0.181
HCM Control Delay (s)	8.6	7.5	0	-	0	-	-	10.5
HCM Lane LOS	A	A	A	-	A	-	-	B
HCM 95th %tile Q(veh)	0	0.1	-	-	0	-	-	0.7

Intersection						
Int Delay, s/veh	0					
Movement	EBT	EBR	WBL	WBT	NBL	NBR
Lane Configurations						
Traffic Vol, veh/h	92	0	0	108	0	0
Future Vol, veh/h	92	0	0	108	0	0
Conflicting Peds, #/hr	0	0	0	0	0	0
Sign Control	Free	Free	Free	Free	Stop	Stop
RT Channelized	-	None	-	None	-	None
Storage Length	-	-	-	-	0	-
Veh in Median Storage, #	0	-	-	0	0	-
Grade, %	0	-	-	0	0	-
Peak Hour Factor	92	92	92	92	92	92
Heavy Vehicles, %	2	2	2	2	2	2
Mvmt Flow	100	0	0	117	0	0

Major/Minor	Major1	Major2	Minor1		
Conflicting Flow All	0	0	100	0	217
Stage 1	-	-	-	-	100
Stage 2	-	-	-	-	117
Critical Hdwy	-	-	4.12	-	6.42
Critical Hdwy Stg 1	-	-	-	-	5.42
Critical Hdwy Stg 2	-	-	-	-	5.42
Follow-up Hdwy	-	-	2.218	-	3.518
Pot Cap-1 Maneuver	-	-	1493	-	771
Stage 1	-	-	-	-	924
Stage 2	-	-	-	-	908
Platoon blocked, %	-	-	-	-	-
Mov Cap-1 Maneuver	-	-	1493	-	771
Mov Cap-2 Maneuver	-	-	-	-	771
Stage 1	-	-	-	-	924
Stage 2	-	-	-	-	908

Approach	EB	WB	NB
HCM Control Delay, s	0	0	0
HCM LOS			A

Minor Lane/Major Mvmt	NBLn1	EBT	EBR	WBL	WBT
Capacity (veh/h)	-	-	-	1493	-
HCM Lane V/C Ratio	-	-	-	-	-
HCM Control Delay (s)	0	-	-	0	-
HCM Lane LOS	A	-	-	A	-
HCM 95th %tile Q(veh)	-	-	-	0	-

Intersection						
Int Delay, s/veh	2					
Movement	EBL	EBR	NBL	NBT	SBT	SBR
Lane Configurations	T			T		
Traffic Vol, veh/h	17	51	74	249	376	31
Future Vol, veh/h	17	51	74	249	376	31
Conflicting Peds, #/hr	0	0	0	0	0	0
Sign Control	Stop	Stop	Free	Free	Free	Free
RT Channelized	-	None	-	None	-	None
Storage Length	0	-	-	-	-	-
Veh in Median Storage, #	0	-	-	0	0	-
Grade, %	0	-	-	0	0	-
Peak Hour Factor	88	88	88	88	88	88
Heavy Vehicles, %	2	3	2	6	8	2
Mvmt Flow	19	58	84	283	427	35

Major/Minor	Minor2	Major1	Major2			
Conflicting Flow All	896	445	462	0	-	0
Stage 1	445	-	-	-	-	-
Stage 2	451	-	-	-	-	-
Critical Hdwy	6.42	6.23	4.12	-	-	-
Critical Hdwy Stg 1	5.42	-	-	-	-	-
Critical Hdwy Stg 2	5.42	-	-	-	-	-
Follow-up Hdwy	3.518	3.327	2.218	-	-	-
Pot Cap-1 Maneuver	311	611	1099	-	-	-
Stage 1	646	-	-	-	-	-
Stage 2	642	-	-	-	-	-
Platoon blocked, %				-	-	-
Mov Cap-1 Maneuver	283	611	1099	-	-	-
Mov Cap-2 Maneuver	283	-	-	-	-	-
Stage 1	587	-	-	-	-	-
Stage 2	642	-	-	-	-	-

Approach	EB	NB	SB
HCM Control Delay, s	14.1	2	0
HCM LOS	B		

Minor Lane/Major Mvmt	NBL	NBT	EBLn1	SBT	SBR
Capacity (veh/h)	1099	-	474	-	-
HCM Lane V/C Ratio	0.077	-	0.163	-	-
HCM Control Delay (s)	8.5	0	14.1	-	-
HCM Lane LOS	A	A	B	-	-
HCM 95th %tile Q(veh)	0.2	-	0.6	-	-

Intersection						
Int Delay, s/veh	0.1					
Movement	EBL	EBR	NBL	NBT	SBT	SBR
Lane Configurations	T			T		
Traffic Vol, veh/h	3	4	1	302	441	1
Future Vol, veh/h	3	4	1	302	441	1
Conflicting Peds, #/hr	0	0	0	0	0	0
Sign Control	Stop	Stop	Free	Free	Free	Free
RT Channelized	-	None	-	None	-	None
Storage Length	0	-	-	-	-	-
Veh in Median Storage, #	0	-	-	0	0	-
Grade, %	0	-	-	0	0	-
Peak Hour Factor	90	90	90	90	90	90
Heavy Vehicles, %	2	2	2	6	7	2
Mvmt Flow	3	4	1	336	490	1

Major/Minor	Minor2	Major1	Major2			
Conflicting Flow All	829	491	491	0	-	0
Stage 1	491	-	-	-	-	-
Stage 2	338	-	-	-	-	-
Critical Hdwy	6.42	6.22	4.12	-	-	-
Critical Hdwy Stg 1	5.42	-	-	-	-	-
Critical Hdwy Stg 2	5.42	-	-	-	-	-
Follow-up Hdwy	3.518	3.318	2.218	-	-	-
Pot Cap-1 Maneuver	340	578	1072	-	-	-
Stage 1	615	-	-	-	-	-
Stage 2	722	-	-	-	-	-
Platoon blocked, %				-	-	-
Mov Cap-1 Maneuver	340	578	1072	-	-	-
Mov Cap-2 Maneuver	340	-	-	-	-	-
Stage 1	614	-	-	-	-	-
Stage 2	722	-	-	-	-	-

Approach	EB	NB	SB
HCM Control Delay, s	13.2	0	0
HCM LOS	B		

Minor Lane/Major Mvmt	NBL	NBT	EBLn1	SBT	SBR
Capacity (veh/h)	1072	-	445	-	-
HCM Lane V/C Ratio	0.001	-	0.017	-	-
HCM Control Delay (s)	8.4	0	13.2	-	-
HCM Lane LOS	A	A	B	-	-
HCM 95th %tile Q(veh)	0	-	0.1	-	-

HCM 6th Signalized Intersection Summary
5: Rays Rd & Memorial Dr

Spivey Lake Residential
No Build AM



Movement	EBU	EBL	EBT	EBR	WBU	WBL	WBT	WBR	NBL	NBT	NBR	SBL
Lane Configurations		2T	3T	T		2T	3T	T	T	2T		2T
Traffic Volume (veh/h)	9	115	809	46	15	15	1311	90	55	105	20	73
Future Volume (veh/h)	9	115	809	46	15	15	1311	90	55	105	20	73
Initial Q (Qb), veh		0	0	0		0	0	0	0	0	0	0
Ped-Bike Adj(A_pbT)		1.00		1.00		1.00		1.00	1.00		1.00	1.00
Parking Bus, Adj		1.00	1.00	1.00		1.00	1.00	1.00	1.00	1.00	1.00	1.00
Work Zone On Approach			No				No			No		
Adj Sat Flow, veh/h/ln		1752	1796	1856		1752	1826	1796	1870	1870	1870	1737
Adj Flow Rate, veh/h		119	834	0		15	1352	0	57	108	21	75
Peak Hour Factor		0.97	0.97	0.97		0.97	0.97	0.97	0.97	0.97	0.97	0.97
Percent Heavy Veh, %		10	7	3		10	5	7	2	2	2	11
Cap, veh/h		179	1936			55	1777		451	909	173	140
Arrive On Green		0.06	0.39	0.00		0.02	0.36	0.00	0.04	0.31	0.31	0.04
Sat Flow, veh/h		3237	4904	1572		3237	4985	1522	1781	2980	565	3209
Grp Volume(v), veh/h		119	834	0		15	1352	0	57	63	66	75
Grp Sat Flow(s),veh/h/ln		1618	1635	1572		1618	1662	1522	1781	1777	1769	1605
Q Serve(g_s), s		3.6	12.4	0.0		0.5	24.0	0.0	2.2	2.6	2.7	2.3
Cycle Q Clear(g_c), s		3.6	12.4	0.0		0.5	24.0	0.0	2.2	2.6	2.7	2.3
Prop In Lane		1.00		1.00		1.00		1.00	1.00		0.32	1.00
Lane Grp Cap(c), veh/h		179	1936			55	1777		451	542	540	140
V/C Ratio(X)		0.67	0.43			0.27	0.76		0.13	0.12	0.12	0.53
Avail Cap(c_a), veh/h		355	2690			161	2436		469	542	540	224
HCM Platoon Ratio		1.00	1.00	1.00		1.00	1.00	1.00	1.00	1.00	1.00	1.00
Upstream Filter(I)		1.00	1.00	0.00		1.00	1.00	0.00	1.00	1.00	1.00	1.00
Uniform Delay (d), s/veh		46.5	22.1	0.0		48.7	28.5	0.0	22.2	25.1	25.1	46.9
Incr Delay (d2), s/veh		4.2	0.2	0.0		2.6	1.0	0.0	0.1	0.4	0.5	3.1
Initial Q Delay(d3),s/veh		0.0	0.0	0.0		0.0	0.0	0.0	0.0	0.0	0.0	0.0
%ile BackOfQ(50%),veh/ln		1.5	4.5	0.0		0.2	9.0	0.0	0.9	1.1	1.2	1.0
Unsig. Movement Delay, s/veh												
LnGrp Delay(d),s/veh		50.7	22.3	0.0		51.3	29.4	0.0	22.4	25.5	25.6	50.1
LnGrp LOS		D	C			D	C		C	C	C	D
Approach Vol, veh/h			953	A			1367	A		186		
Approach Delay, s/veh			25.8				29.7			24.6		
Approach LOS			C				C			C		
Timer - Assigned Phs	1	2	3	4	5	6	7	8				
Phs Duration (G+Y+Rc), s	11.5	41.8	10.0	37.0	7.7	45.6	10.4	36.6				
Change Period (Y+Rc), s	6.0	6.0	6.0	6.0	6.0	6.0	6.0	6.0				
Max Green Setting (Gmax), s	11.0	49.0	5.0	31.0	5.0	55.0	7.0	29.0				
Max Q Clear Time (g_c+I1), s	5.6	26.0	4.2	18.2	2.5	14.4	4.3	4.7				
Green Ext Time (p_c), s	0.1	9.7	0.0	1.1	0.0	6.2	0.0	0.6				

Intersection Summary

HCM 6th Ctrl Delay	29.1
HCM 6th LOS	C

Notes

User approved ignoring U-Turning movement.
Unsignalized Delay for [EBR, WBR] is excluded from calculations of the approach delay and intersection delay.

HCM 6th Signalized Intersection Summary
 5: Rays Rd & Memorial Dr

Spivey Lake Residential
 No Build AM



Movement	SBT	SBR
Lane Configurations	↑↑	↑
Traffic Volume (veh/h)	55	279
Future Volume (veh/h)	55	279
Initial Q (Qb), veh	0	0
Ped-Bike Adj(A_pbT)		1.00
Parking Bus, Adj	1.00	1.00
Work Zone On Approach	No	
Adj Sat Flow, veh/h/ln	1870	1796
Adj Flow Rate, veh/h	57	288
Peak Hour Factor	0.97	0.97
Percent Heavy Veh, %	2	7
Cap, veh/h	1099	471
Arrive On Green	0.31	0.31
Sat Flow, veh/h	3554	1522
Grp Volume(v), veh/h	57	288
Grp Sat Flow(s),veh/h/ln	1777	1522
Q Serve(g_s), s	1.1	16.2
Cycle Q Clear(g_c), s	1.1	16.2
Prop In Lane		1.00
Lane Grp Cap(c), veh/h	1099	471
V/C Ratio(X)	0.05	0.61
Avail Cap(c_a), veh/h	1099	471
HCM Platoon Ratio	1.00	1.00
Upstream Filter(l)	1.00	1.00
Uniform Delay (d), s/veh	24.3	29.5
Incr Delay (d2), s/veh	0.1	5.8
Initial Q Delay(d3),s/veh	0.0	0.0
%ile BackOfQ(50%),veh/ln	0.5	6.5
Unsig. Movement Delay, s/veh		
LnGrp Delay(d),s/veh	24.4	35.3
LnGrp LOS	C	D
Approach Vol, veh/h	420	
Approach Delay, s/veh	36.5	
Approach LOS	D	
Timer - Assigned Phs		

Intersection												
Int Delay, s/veh	1.5											
Movement	EBL	EBT	EBR	WBL	WBT	WBR	NBL	NBT	NBR	SBL	SBT	SBR
Lane Configurations		↕			↕			↕			↕	
Traffic Vol, veh/h	14	147	0	0	74	9	0	1	1	13	1	13
Future Vol, veh/h	14	147	0	0	74	9	0	1	1	13	1	13
Conflicting Peds, #/hr	0	0	0	0	0	0	0	0	0	0	0	0
Sign Control	Free	Free	Free	Free	Free	Free	Stop	Stop	Stop	Stop	Stop	Stop
RT Channelized	-	-	None	-	-	None	-	-	None	-	-	None
Storage Length	-	-	-	-	-	-	-	-	-	-	-	-
Veh in Median Storage, #	-	0	-	-	0	-	-	0	-	-	0	-
Grade, %	-	0	-	-	0	-	-	0	-	-	0	-
Peak Hour Factor	91	91	91	91	91	91	91	91	91	91	91	91
Heavy Vehicles, %	8	2	2	2	3	2	2	2	2	2	2	2
Mvmt Flow	15	162	0	0	81	10	0	1	1	14	1	14

Major/Minor	Major1		Major2			Minor1			Minor2			
Conflicting Flow All	91	0	0	162	0	0	286	283	162	279	278	86
Stage 1	-	-	-	-	-	-	192	192	-	86	86	-
Stage 2	-	-	-	-	-	-	94	91	-	193	192	-
Critical Hdwy	4.18	-	-	4.12	-	-	7.12	6.52	6.22	7.12	6.52	6.22
Critical Hdwy Stg 1	-	-	-	-	-	-	6.12	5.52	-	6.12	5.52	-
Critical Hdwy Stg 2	-	-	-	-	-	-	6.12	5.52	-	6.12	5.52	-
Follow-up Hdwy	2.272	-	-	2.218	-	-	3.518	4.018	3.318	3.518	4.018	3.318
Pot Cap-1 Maneuver	1467	-	-	1417	-	-	666	626	883	673	630	973
Stage 1	-	-	-	-	-	-	810	742	-	922	824	-
Stage 2	-	-	-	-	-	-	913	820	-	809	742	-
Platoon blocked, %	-	-	-	-	-	-	-	-	-	-	-	-
Mov Cap-1 Maneuver	1467	-	-	1417	-	-	650	619	883	666	623	973
Mov Cap-2 Maneuver	-	-	-	-	-	-	650	619	-	666	623	-
Stage 1	-	-	-	-	-	-	801	734	-	912	824	-
Stage 2	-	-	-	-	-	-	898	820	-	798	734	-

Approach	EB	WB	NB	SB
HCM Control Delay, s	0.7	0	10	9.8
HCM LOS			B	A

Minor Lane/Major Mvmt	NBLn1	EBL	EBT	EBR	WBL	WBT	WBR	SBLn1
Capacity (veh/h)	728	1467	-	-	1417	-	-	783
HCM Lane V/C Ratio	0.003	0.01	-	-	-	-	-	0.038
HCM Control Delay (s)	10	7.5	0	-	0	-	-	9.8
HCM Lane LOS	B	A	A	-	A	-	-	A
HCM 95th %tile Q(veh)	0	0	-	-	0	-	-	0.1

Intersection						
Int Delay, s/veh	0					
Movement	EBT	EBR	WBL	WBT	NBL	NBR
Lane Configurations						
Traffic Vol, veh/h	166	0	0	93	0	0
Future Vol, veh/h	166	0	0	93	0	0
Conflicting Peds, #/hr	0	0	0	0	0	0
Sign Control	Free	Free	Free	Free	Stop	Stop
RT Channelized	-	None	-	None	-	None
Storage Length	-	-	-	-	0	-
Veh in Median Storage, #	0	-	-	0	0	-
Grade, %	0	-	-	0	0	-
Peak Hour Factor	92	92	92	92	92	92
Heavy Vehicles, %	2	2	2	2	2	2
Mvmt Flow	180	0	0	101	0	0

Major/Minor	Major1	Major2	Minor1	Minor2	Minor3
Conflicting Flow All	0	0	180	0	281
Stage 1	-	-	-	-	180
Stage 2	-	-	-	-	101
Critical Hdwy	-	-	4.12	-	6.42
Critical Hdwy Stg 1	-	-	-	-	5.42
Critical Hdwy Stg 2	-	-	-	-	5.42
Follow-up Hdwy	-	-	2.218	-	3.518
Pot Cap-1 Maneuver	-	-	1396	-	709
Stage 1	-	-	-	-	851
Stage 2	-	-	-	-	923
Platoon blocked, %	-	-	-	-	-
Mov Cap-1 Maneuver	-	-	1396	-	709
Mov Cap-2 Maneuver	-	-	-	-	709
Stage 1	-	-	-	-	851
Stage 2	-	-	-	-	923

Approach	EB	WB	NB
HCM Control Delay, s	0	0	0
HCM LOS			A

Minor Lane/Major Mvmt	NBLn1	EBT	EBR	WBL	WBT
Capacity (veh/h)	-	-	-	1396	-
HCM Lane V/C Ratio	-	-	-	-	-
HCM Control Delay (s)	0	-	-	0	-
HCM Lane LOS	A	-	-	A	-
HCM 95th %tile Q(veh)	-	-	-	0	-

Intersection						
Int Delay, s/veh	3.7					
Movement	EBL	EBR	NBL	NBT	SBT	SBR
Lane Configurations	T		T		T	
Traffic Vol, veh/h	36	124	66	340	558	24
Future Vol, veh/h	36	124	66	340	558	24
Conflicting Peds, #/hr	0	0	0	0	0	0
Sign Control	Stop	Stop	Free	Free	Free	Free
RT Channelized	-	None	-	None	-	None
Storage Length	0	-	-	-	-	-
Veh in Median Storage, #	0	-	-	0	0	-
Grade, %	0	-	-	0	0	-
Peak Hour Factor	92	92	92	92	92	92
Heavy Vehicles, %	2	2	2	2	2	5
Mvmt Flow	39	135	72	370	607	26

Major/Minor	Minor2	Major1	Major2			
Conflicting Flow All	1134	620	633	0	-	0
Stage 1	620	-	-	-	-	-
Stage 2	514	-	-	-	-	-
Critical Hdwy	6.42	6.22	4.12	-	-	-
Critical Hdwy Stg 1	5.42	-	-	-	-	-
Critical Hdwy Stg 2	5.42	-	-	-	-	-
Follow-up Hdwy	3.518	3.318	2.218	-	-	-
Pot Cap-1 Maneuver	224	488	950	-	-	-
Stage 1	536	-	-	-	-	-
Stage 2	600	-	-	-	-	-
Platoon blocked, %				-	-	-
Mov Cap-1 Maneuver	203	488	950	-	-	-
Mov Cap-2 Maneuver	203	-	-	-	-	-
Stage 1	485	-	-	-	-	-
Stage 2	600	-	-	-	-	-

Approach	EB	NB	SB
HCM Control Delay, s	23	1.5	0
HCM LOS	C		

Minor Lane/Major Mvmt	NBL	NBT	EBLn1	SBT	SBR
Capacity (veh/h)	950	-	371	-	-
HCM Lane V/C Ratio	0.076	-	0.469	-	-
HCM Control Delay (s)	9.1	0	23	-	-
HCM Lane LOS	A	A	C	-	-
HCM 95th %tile Q(veh)	0.2	-	2.4	-	-

Intersection						
Int Delay, s/veh	0.3					
Movement	EBL	EBR	NBL	NBT	SBT	SBR
Lane Configurations	T			T		
Traffic Vol, veh/h	3	10	12	397	675	2
Future Vol, veh/h	3	10	12	397	675	2
Conflicting Peds, #/hr	0	0	0	0	0	0
Sign Control	Stop	Stop	Free	Free	Free	Free
RT Channelized	-	None	-	None	-	None
Storage Length	0	-	-	-	-	-
Veh in Median Storage, #	0	-	-	0	0	-
Grade, %	0	-	-	0	0	-
Peak Hour Factor	89	89	89	89	89	89
Heavy Vehicles, %	2	2	2	2	2	2
Mvmt Flow	3	11	13	446	758	2

Major/Minor	Minor2	Major1	Major2			
Conflicting Flow All	1231	759	760	0	-	0
Stage 1	759	-	-	-	-	-
Stage 2	472	-	-	-	-	-
Critical Hdwy	6.42	6.22	4.12	-	-	-
Critical Hdwy Stg 1	5.42	-	-	-	-	-
Critical Hdwy Stg 2	5.42	-	-	-	-	-
Follow-up Hdwy	3.518	3.318	2.218	-	-	-
Pot Cap-1 Maneuver	196	406	852	-	-	-
Stage 1	462	-	-	-	-	-
Stage 2	628	-	-	-	-	-
Platoon blocked, %				-	-	-
Mov Cap-1 Maneuver	192	406	852	-	-	-
Mov Cap-2 Maneuver	192	-	-	-	-	-
Stage 1	453	-	-	-	-	-
Stage 2	628	-	-	-	-	-

Approach	EB	NB	SB
HCM Control Delay, s	16.7	0.3	0
HCM LOS	C		

Minor Lane/Major Mvmt	NBL	NBT	EBLn1	SBT	SBR
Capacity (veh/h)	852	-	323	-	-
HCM Lane V/C Ratio	0.016	-	0.045	-	-
HCM Control Delay (s)	9.3	0	16.7	-	-
HCM Lane LOS	A	A	C	-	-
HCM 95th %tile Q(veh)	0	-	0.1	-	-

HCM 6th Signalized Intersection Summary
5: Rays Rd & Memorial Dr

Spivey Lake Residential
No Build PM

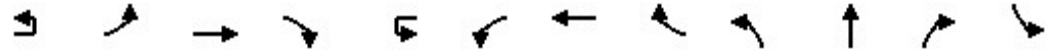

Movement	EBU	EBL	EBT	EBR	WBU	WBL	WBT	WBR	NBL	NBT	NBR	SBL
Lane Configurations		⇌	⇌	⇌		⇌	⇌	⇌	⇌	⇌		⇌
Traffic Volume (veh/h)	10	206	1456	77	15	42	1228	140	65	88	44	186
Future Volume (veh/h)	10	206	1456	77	15	42	1228	140	65	88	44	186
Initial Q (Qb), veh		0	0	0		0	0	0	0	0	0	0
Ped-Bike Adj(A_pbT)		1.00		1.00		1.00		1.00	1.00		1.00	1.00
Parking Bus, Adj		1.00	1.00	1.00		1.00	1.00	1.00	1.00	1.00	1.00	1.00
Work Zone On Approach			No				No			No		
Adj Sat Flow, veh/h/ln		1870	1870	1870		1870	1870	1870	1870	1870	1870	1870
Adj Flow Rate, veh/h		217	1533	0		44	1293	0	68	93	46	196
Peak Hour Factor		0.95	0.95	0.95		0.95	0.95	0.95	0.95	0.95	0.95	0.95
Percent Heavy Veh, %		2	2	2		2	2	2	2	2	2	2
Cap, veh/h		289	2015			120	1765		362	619	288	265
Arrive On Green		0.08	0.39	0.00		0.03	0.35	0.00	0.04	0.26	0.26	0.08
Sat Flow, veh/h		3456	5106	1585		3456	5106	1585	1781	2354	1096	3456
Grp Volume(v), veh/h		217	1533	0		44	1293	0	68	69	70	196
Grp Sat Flow(s),veh/h/ln		1728	1702	1585		1728	1702	1585	1781	1777	1673	1728
Q Serve(g_s), s		6.4	27.0	0.0		1.3	23.1	0.0	2.9	3.1	3.4	5.8
Cycle Q Clear(g_c), s		6.4	27.0	0.0		1.3	23.1	0.0	2.9	3.1	3.4	5.8
Prop In Lane		1.00		1.00		1.00		1.00	1.00		0.66	1.00
Lane Grp Cap(c), veh/h		289	2015			120	1765		362	467	440	265
V/C Ratio(X)		0.75	0.76			0.37	0.73		0.19	0.15	0.16	0.74
Avail Cap(c_a), veh/h		466	2703			166	2261		374	467	440	399
HCM Platoon Ratio		1.00	1.00	1.00		1.00	1.00	1.00	1.00	1.00	1.00	1.00
Upstream Filter(l)		1.00	1.00	0.00		1.00	1.00	0.00	1.00	1.00	1.00	1.00
Uniform Delay (d), s/veh		46.5	27.2	0.0		49.0	29.8	0.0	26.1	29.3	29.4	46.9
Incr Delay (d2), s/veh		3.9	0.9	0.0		1.9	0.9	0.0	0.2	0.7	0.8	4.0
Initial Q Delay(d3),s/veh		0.0	0.0	0.0		0.0	0.0	0.0	0.0	0.0	0.0	0.0
%ile BackOfQ(50%),veh/ln		2.8	10.3	0.0		0.6	9.0	0.0	1.2	1.4	1.4	2.6
Unsig. Movement Delay, s/veh												
LnGrp Delay(d),s/veh		50.5	28.1	0.0		50.9	30.7	0.0	26.4	30.0	30.2	51.0
LnGrp LOS		D	C			D	C		C	C	C	D
Approach Vol, veh/h			1750	A			1337	A		207		
Approach Delay, s/veh			30.9				31.4			28.9		
Approach LOS			C				C			C		
Timer - Assigned Phs	1	2	3	4	5	6	7	8				
Phs Duration (G+Y+Rc), s	14.7	41.9	10.3	37.0	9.6	47.0	14.0	33.3				
Change Period (Y+Rc), s	6.0	6.0	6.0	6.0	6.0	6.0	6.0	6.0				
Max Green Setting (Gmax), s	14.0	46.0	5.0	31.0	5.0	55.0	12.0	24.0				
Max Q Clear Time (g_c+I1), s	8.4	25.1	4.9	22.5	3.3	29.0	7.8	5.4				
Green Ext Time (p_c), s	0.3	8.8	0.0	1.7	0.0	12.0	0.2	0.6				

Intersection Summary

HCM 6th Ctrl Delay	32.7
HCM 6th LOS	C

Notes

User approved ignoring U-Turning movement.
Unsignalized Delay for [EBR, WBR] is excluded from calculations of the approach delay and intersection delay.

HCM 6th Signalized Intersection Summary
 5: Rays Rd & Memorial Dr

Spivey Lake Residential
 No Build PM



Movement	SBT	SBR
Lane Configurations	↑↑	↑
Traffic Volume (veh/h)	193	331
Future Volume (veh/h)	193	331
Initial Q (Qb), veh	0	0
Ped-Bike Adj(A_pbT)		1.00
Parking Bus, Adj	1.00	1.00
Work Zone On Approach	No	
Adj Sat Flow, veh/h/ln	1870	1870
Adj Flow Rate, veh/h	203	348
Peak Hour Factor	0.95	0.95
Percent Heavy Veh, %	2	2
Cap, veh/h	1060	473
Arrive On Green	0.30	0.30
Sat Flow, veh/h	3554	1585
Grp Volume(v), veh/h	203	348
Grp Sat Flow(s),veh/h/ln	1777	1585
Q Serve(g_s), s	4.4	20.5
Cycle Q Clear(g_c), s	4.4	20.5
Prop In Lane		1.00
Lane Grp Cap(c), veh/h	1060	473
V/C Ratio(X)	0.19	0.74
Avail Cap(c_a), veh/h	1060	473
HCM Platoon Ratio	1.00	1.00
Upstream Filter(l)	1.00	1.00
Uniform Delay (d), s/veh	27.1	32.8
Incr Delay (d2), s/veh	0.4	9.8
Initial Q Delay(d3),s/veh	0.0	0.0
%ile BackOfQ(50%),veh/ln	1.9	8.9
Unsig. Movement Delay, s/veh		
LnGrp Delay(d),s/veh	27.5	42.5
LnGrp LOS	C	D
Approach Vol, veh/h	747	
Approach Delay, s/veh	40.7	
Approach LOS	D	
Timer - Assigned Phs		

Intersection												
Int Delay, s/veh	4.6											
Movement	EBL	EBT	EBR	WBL	WBT	WBR	NBL	NBT	NBR	SBL	SBT	SBR
Lane Configurations		↕			↕			↕			↕	
Traffic Vol, veh/h	30	61	2	1	102	27	7	0	5	34	0	81
Future Vol, veh/h	30	61	2	1	102	27	7	0	5	34	0	81
Conflicting Peds, #/hr	0	0	0	0	0	0	0	0	0	0	0	0
Sign Control	Free	Free	Free	Free	Free	Free	Stop	Stop	Stop	Stop	Stop	Stop
RT Channelized	-	-	None	-	-	None	-	-	None	-	-	None
Storage Length	-	-	-	-	-	-	-	-	-	-	-	-
Veh in Median Storage, #	-	0	-	-	0	-	-	0	-	-	0	-
Grade, %	-	0	-	-	0	-	-	0	-	-	0	-
Peak Hour Factor	79	79	79	79	79	79	79	79	79	79	79	79
Heavy Vehicles, %	2	9	2	2	12	6	2	2	2	23	2	14
Mvmt Flow	38	77	3	1	129	34	9	0	6	43	0	103

Major/Minor	Major1			Major2			Minor1			Minor2		
Conflicting Flow All	163	0	0	80	0	0	355	320	79	306	304	146
Stage 1	-	-	-	-	-	-	155	155	-	148	148	-
Stage 2	-	-	-	-	-	-	200	165	-	158	156	-
Critical Hdwy	4.12	-	-	4.12	-	-	7.12	6.52	6.22	7.33	6.52	6.34
Critical Hdwy Stg 1	-	-	-	-	-	-	6.12	5.52	-	6.33	5.52	-
Critical Hdwy Stg 2	-	-	-	-	-	-	6.12	5.52	-	6.33	5.52	-
Follow-up Hdwy	2.218	-	-	2.218	-	-	3.518	4.018	3.318	3.707	4.018	3.426
Pot Cap-1 Maneuver	1416	-	-	1518	-	-	600	597	981	607	609	870
Stage 1	-	-	-	-	-	-	847	769	-	807	775	-
Stage 2	-	-	-	-	-	-	802	762	-	797	769	-
Platoon blocked, %	-	-	-	-	-	-	-	-	-	-	-	-
Mov Cap-1 Maneuver	1416	-	-	1518	-	-	518	580	981	590	591	870
Mov Cap-2 Maneuver	-	-	-	-	-	-	518	580	-	590	591	-
Stage 1	-	-	-	-	-	-	823	747	-	784	774	-
Stage 2	-	-	-	-	-	-	707	761	-	770	747	-

Approach	EB			WB			NB			SB		
HCM Control Delay, s	2.5			0.1			10.7			10.8		
HCM LOS							B			B		

Minor Lane/Major Mvmt	NBLn1	EBL	EBT	EBR	WBL	WBT	WBR	SBLn1
Capacity (veh/h)	645	1416	-	-	1518	-	-	763
HCM Lane V/C Ratio	0.024	0.027	-	-	0.001	-	-	0.191
HCM Control Delay (s)	10.7	7.6	0	-	7.4	0	-	10.8
HCM Lane LOS	B	A	A	-	A	A	-	B
HCM 95th %tile Q(veh)	0.1	0.1	-	-	0	-	-	0.7

Intersection						
Int Delay, s/veh	1.7					
Movement	EBT	EBR	WBL	WBT	NBL	NBR
Lane Configurations						
Traffic Vol, veh/h	96	7	5	109	24	17
Future Vol, veh/h	96	7	5	109	24	17
Conflicting Peds, #/hr	0	0	0	0	0	0
Sign Control	Free	Free	Free	Free	Stop	Stop
RT Channelized	-	None	-	None	-	None
Storage Length	-	-	-	-	0	-
Veh in Median Storage, #	0	-	-	0	0	-
Grade, %	0	-	-	0	0	-
Peak Hour Factor	92	92	92	92	92	92
Heavy Vehicles, %	2	2	2	2	2	2
Mvmt Flow	104	8	5	118	26	18

Major/Minor	Major1	Major2	Minor1		
Conflicting Flow All	0	0	112	0	236 108
Stage 1	-	-	-	-	108 -
Stage 2	-	-	-	-	128 -
Critical Hdwy	-	-	4.12	-	6.42 6.22
Critical Hdwy Stg 1	-	-	-	-	5.42 -
Critical Hdwy Stg 2	-	-	-	-	5.42 -
Follow-up Hdwy	-	-	2.218	-	3.518 3.318
Pot Cap-1 Maneuver	-	-	1478	-	752 946
Stage 1	-	-	-	-	916 -
Stage 2	-	-	-	-	898 -
Platoon blocked, %	-	-	-	-	-
Mov Cap-1 Maneuver	-	-	1478	-	749 946
Mov Cap-2 Maneuver	-	-	-	-	749 -
Stage 1	-	-	-	-	916 -
Stage 2	-	-	-	-	894 -

Approach	EB	WB	NB
HCM Control Delay, s	0	0.3	9.6
HCM LOS			A

Minor Lane/Major Mvmt	NBLn1	EBT	EBR	WBL	WBT
Capacity (veh/h)	820	-	-	1478	-
HCM Lane V/C Ratio	0.054	-	-	0.004	-
HCM Control Delay (s)	9.6	-	-	7.4	0
HCM Lane LOS	A	-	-	A	A
HCM 95th %tile Q(veh)	0.2	-	-	0	-

Intersection						
Int Delay, s/veh	2.4					
Movement	EBL	EBR	NBL	NBT	SBT	SBR
Lane Configurations	T			T		
Traffic Vol, veh/h	22	67	79	261	380	32
Future Vol, veh/h	22	67	79	261	380	32
Conflicting Peds, #/hr	0	0	0	0	0	0
Sign Control	Stop	Stop	Free	Free	Free	Free
RT Channelized	-	None	-	None	-	None
Storage Length	0	-	-	-	-	-
Veh in Median Storage, #	0	-	-	0	0	-
Grade, %	0	-	-	0	0	-
Peak Hour Factor	88	88	88	88	88	88
Heavy Vehicles, %	2	3	2	6	8	2
Mvmt Flow	25	76	90	297	432	36

Major/Minor	Minor2	Major1		Major2	
Conflicting Flow All	927	450	468	0	0
Stage 1	450	-	-	-	-
Stage 2	477	-	-	-	-
Critical Hdwy	6.42	6.23	4.12	-	-
Critical Hdwy Stg 1	5.42	-	-	-	-
Critical Hdwy Stg 2	5.42	-	-	-	-
Follow-up Hdwy	3.518	3.327	2.218	-	-
Pot Cap-1 Maneuver	298	607	1094	-	-
Stage 1	642	-	-	-	-
Stage 2	624	-	-	-	-
Platoon blocked, %				-	-
Mov Cap-1 Maneuver	269	607	1094	-	-
Mov Cap-2 Maneuver	269	-	-	-	-
Stage 1	579	-	-	-	-
Stage 2	624	-	-	-	-

Approach	EB	NB	SB
HCM Control Delay, s	14.9	2	0
HCM LOS	B		

Minor Lane/Major Mvmt	NBL	NBT	EBLn1	SBT	SBR
Capacity (veh/h)	1094	-	463	-	-
HCM Lane V/C Ratio	0.082	-	0.218	-	-
HCM Control Delay (s)	8.6	0	14.9	-	-
HCM Lane LOS	A	A	B	-	-
HCM 95th %tile Q(veh)	0.3	-	0.8	-	-

Intersection						
Int Delay, s/veh	0.9					
Movement	EBL	EBR	NBL	NBT	SBT	SBR
Lane Configurations	T			T		
Traffic Vol, veh/h	15	33	10	307	457	5
Future Vol, veh/h	15	33	10	307	457	5
Conflicting Peds, #/hr	0	0	0	0	0	0
Sign Control	Stop	Stop	Free	Free	Free	Free
RT Channelized	-	None	-	None	-	None
Storage Length	0	-	-	-	-	-
Veh in Median Storage, #	0	-	-	0	0	-
Grade, %	0	-	-	0	0	-
Peak Hour Factor	90	90	90	90	90	90
Heavy Vehicles, %	2	2	2	6	7	2
Mvmt Flow	17	37	11	341	508	6

Major/Minor	Minor2	Major1	Major2			
Conflicting Flow All	874	511	514	0	-	0
Stage 1	511	-	-	-	-	-
Stage 2	363	-	-	-	-	-
Critical Hdwy	6.42	6.22	4.12	-	-	-
Critical Hdwy Stg 1	5.42	-	-	-	-	-
Critical Hdwy Stg 2	5.42	-	-	-	-	-
Follow-up Hdwy	3.518	3.318	2.218	-	-	-
Pot Cap-1 Maneuver	320	563	1052	-	-	-
Stage 1	602	-	-	-	-	-
Stage 2	704	-	-	-	-	-
Platoon blocked, %				-	-	-
Mov Cap-1 Maneuver	316	563	1052	-	-	-
Mov Cap-2 Maneuver	316	-	-	-	-	-
Stage 1	594	-	-	-	-	-
Stage 2	704	-	-	-	-	-

Approach	EB	NB	SB
HCM Control Delay, s	14	0.3	0
HCM LOS	B		

Minor Lane/Major Mvmt	NBL	NBT	EBLn1	SBT	SBR
Capacity (veh/h)	1052	-	452	-	-
HCM Lane V/C Ratio	0.011	-	0.118	-	-
HCM Control Delay (s)	8.5	0	14	-	-
HCM Lane LOS	A	A	B	-	-
HCM 95th %tile Q(veh)	0	-	0.4	-	-

HCM 6th Signalized Intersection Summary
5: Rays Rd & Memorial Dr

Spivey Lake Residential
Build AM

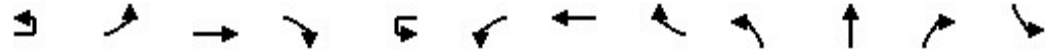

Movement	EBU	EBL	EBT	EBR	WBU	WBL	WBT	WBR	NBL	NBT	NBR	SBL
Lane Configurations		37	↑↑↑	7		37	↑↑↑	7	7	↑↑		77
Traffic Volume (veh/h)	9	121	809	46	15	15	1311	94	55	108	20	87
Future Volume (veh/h)	9	121	809	46	15	15	1311	94	55	108	20	87
Initial Q (Qb), veh		0	0	0		0	0	0	0	0	0	0
Ped-Bike Adj(A_pbT)		1.00		1.00		1.00		1.00	1.00		1.00	1.00
Parking Bus, Adj		1.00	1.00	1.00		1.00	1.00	1.00	1.00	1.00	1.00	1.00
Work Zone On Approach			No				No			No		
Adj Sat Flow, veh/h/ln		1752	1796	1856		1752	1826	1796	1870	1870	1870	1737
Adj Flow Rate, veh/h		125	834	0		15	1352	0	57	111	21	90
Peak Hour Factor		0.97	0.97	0.97		0.97	0.97	0.97	0.97	0.97	0.97	0.97
Percent Heavy Veh, %		10	7	3		10	5	7	2	2	2	11
Cap, veh/h		183	1924			55	1759		448	939	173	144
Arrive On Green		0.06	0.39	0.00		0.02	0.35	0.00	0.04	0.31	0.31	0.04
Sat Flow, veh/h		3237	4904	1572		3237	4985	1522	1781	2994	553	3209
Grp Volume(v), veh/h		125	834	0		15	1352	0	57	65	67	90
Grp Sat Flow(s),veh/h/ln		1618	1635	1572		1618	1662	1522	1781	1777	1771	1605
Q Serve(g_s), s		3.9	12.9	0.0		0.5	24.9	0.0	2.2	2.7	2.8	2.8
Cycle Q Clear(g_c), s		3.9	12.9	0.0		0.5	24.9	0.0	2.2	2.7	2.8	2.8
Prop In Lane		1.00		1.00		1.00		1.00	1.00		0.31	1.00
Lane Grp Cap(c), veh/h		183	1924			55	1759		448	557	555	144
V/C Ratio(X)		0.68	0.43			0.27	0.77		0.13	0.12	0.12	0.63
Avail Cap(c_a), veh/h		282	2516			157	2364		465	557	555	217
HCM Platoon Ratio		1.00	1.00	1.00		1.00	1.00	1.00	1.00	1.00	1.00	1.00
Upstream Filter(l)		1.00	1.00	0.00		1.00	1.00	0.00	1.00	1.00	1.00	1.00
Uniform Delay (d), s/veh		47.8	23.0	0.0		50.2	29.7	0.0	22.4	25.3	25.3	48.5
Incr Delay (d2), s/veh		4.5	0.2	0.0		2.7	1.1	0.0	0.1	0.4	0.4	4.4
Initial Q Delay(d3),s/veh		0.0	0.0	0.0		0.0	0.0	0.0	0.0	0.0	0.0	0.0
%ile BackOfQ(50%),veh/ln		1.6	4.7	0.0		0.2	9.5	0.0	0.9	1.2	1.2	1.2
Unsig. Movement Delay, s/veh												
LnGrp Delay(d),s/veh		52.3	23.1	0.0		52.8	30.8	0.0	22.5	25.7	25.7	52.9
LnGrp LOS		D	C			D	C		C	C	C	D
Approach Vol, veh/h			959	A			1367	A		189		
Approach Delay, s/veh			26.9				31.0			24.7		
Approach LOS			C				C			C		
Timer - Assigned Phs	1	2	3	4	5	6	7	8				
Phs Duration (G+Y+Rc), s	11.8	42.5	10.0	39.0	7.7	46.5	10.6	38.4				
Change Period (Y+Rc), s	6.0	6.0	6.0	6.0	6.0	6.0	6.0	6.0				
Max Green Setting (Gmax), s	9.0	49.0	5.0	33.0	5.0	53.0	7.0	31.0				
Max Q Clear Time (g_c+I1), s	5.9	26.9	4.2	19.9	2.5	14.9	4.8	4.8				
Green Ext Time (p_c), s	0.1	9.6	0.0	1.2	0.0	6.1	0.0	0.7				

Intersection Summary

HCM 6th Ctrl Delay	30.4
HCM 6th LOS	C

Notes

User approved ignoring U-Turning movement.
Unsignalized Delay for [EBR, WBR] is excluded from calculations of the approach delay and intersection delay.

HCM 6th Signalized Intersection Summary
 5: Rays Rd & Memorial Dr

Spivey Lake Residential
 Build AM



Movement	SBT	SBR
Lane Configurations	↑↑	↑
Traffic Volume (veh/h)	64	300
Future Volume (veh/h)	64	300
Initial Q (Qb), veh	0	0
Ped-Bike Adj(A_pbT)		1.00
Parking Bus, Adj	1.00	1.00
Work Zone On Approach	No	
Adj Sat Flow, veh/h/ln	1870	1796
Adj Flow Rate, veh/h	66	309
Peak Hour Factor	0.97	0.97
Percent Heavy Veh, %	2	7
Cap, veh/h	1135	486
Arrive On Green	0.32	0.32
Sat Flow, veh/h	3554	1522
Grp Volume(v), veh/h	66	309
Grp Sat Flow(s),veh/h/ln	1777	1522
Q Serve(g_s), s	1.3	17.9
Cycle Q Clear(g_c), s	1.3	17.9
Prop In Lane		1.00
Lane Grp Cap(c), veh/h	1135	486
V/C Ratio(X)	0.06	0.64
Avail Cap(c_a), veh/h	1135	486
HCM Platoon Ratio	1.00	1.00
Upstream Filter(l)	1.00	1.00
Uniform Delay (d), s/veh	24.4	30.0
Incr Delay (d2), s/veh	0.1	6.2
Initial Q Delay(d3),s/veh	0.0	0.0
%ile BackOfQ(50%),veh/ln	0.6	7.2
Unsig. Movement Delay, s/veh		
LnGrp Delay(d),s/veh	24.5	36.2
LnGrp LOS	C	D
Approach Vol, veh/h	465	
Approach Delay, s/veh	37.8	
Approach LOS	D	
Timer - Assigned Phs		

Intersection												
Int Delay, s/veh	1.5											
Movement	EBL	EBT	EBR	WBL	WBT	WBR	NBL	NBT	NBR	SBL	SBT	SBR
Lane Configurations		↕			↕			↕			↕	
Traffic Vol, veh/h	14	171	7	4	88	9	4	1	3	13	1	13
Future Vol, veh/h	14	171	7	4	88	9	4	1	3	13	1	13
Conflicting Peds, #/hr	0	0	0	0	0	0	0	0	0	0	0	0
Sign Control	Free	Free	Free	Free	Free	Free	Stop	Stop	Stop	Stop	Stop	Stop
RT Channelized	-	-	None	-	-	None	-	-	None	-	-	None
Storage Length	-	-	-	-	-	-	-	-	-	-	-	-
Veh in Median Storage, #	-	0	-	-	0	-	-	0	-	-	0	-
Grade, %	-	0	-	-	0	-	-	0	-	-	0	-
Peak Hour Factor	91	91	91	91	91	91	91	91	91	91	91	91
Heavy Vehicles, %	8	2	2	2	3	2	2	2	2	2	2	2
Mvmt Flow	15	188	8	4	97	10	4	1	3	14	1	14

Major/Minor	Major1		Major2		Minor1		Minor2					
Conflicting Flow All	107	0	0	196	0	0	340	337	192	334	336	102
Stage 1	-	-	-	-	-	-	222	222	-	110	110	-
Stage 2	-	-	-	-	-	-	118	115	-	224	226	-
Critical Hdwy	4.18	-	-	4.12	-	-	7.12	6.52	6.22	7.12	6.52	6.22
Critical Hdwy Stg 1	-	-	-	-	-	-	6.12	5.52	-	6.12	5.52	-
Critical Hdwy Stg 2	-	-	-	-	-	-	6.12	5.52	-	6.12	5.52	-
Follow-up Hdwy	2.272	-	-	2.218	-	-	3.518	4.018	3.318	3.518	4.018	3.318
Pot Cap-1 Maneuver	1447	-	-	1377	-	-	614	584	850	620	585	953
Stage 1	-	-	-	-	-	-	780	720	-	895	804	-
Stage 2	-	-	-	-	-	-	887	800	-	779	717	-
Platoon blocked, %	-	-	-	-	-	-	-	-	-	-	-	-
Mov Cap-1 Maneuver	1447	-	-	1377	-	-	597	575	850	609	576	953
Mov Cap-2 Maneuver	-	-	-	-	-	-	597	575	-	609	576	-
Stage 1	-	-	-	-	-	-	771	711	-	884	802	-
Stage 2	-	-	-	-	-	-	870	798	-	765	708	-

Approach	EB		WB		NB		SB	
HCM Control Delay, s	0.5		0.3		10.5		10.1	
HCM LOS					B		B	

Minor Lane/Major Mvmt	NBLn1	EBL	EBT	EBR	WBL	WBT	WBR	SBLn1
Capacity (veh/h)	668	1447	-	-	1377	-	-	735
HCM Lane V/C Ratio	0.013	0.011	-	-	0.003	-	-	0.04
HCM Control Delay (s)	10.5	7.5	0	-	7.6	0	-	10.1
HCM Lane LOS	B	A	A	-	A	A	-	B
HCM 95th %tile Q(veh)	0	0	-	-	0	-	-	0.1

Intersection						
Int Delay, s/veh	1.1					
Movement	EBT	EBR	WBL	WBT	NBL	NBR
Lane Configurations						
Traffic Vol, veh/h	168	24	17	97	14	10
Future Vol, veh/h	168	24	17	97	14	10
Conflicting Peds, #/hr	0	0	0	0	0	0
Sign Control	Free	Free	Free	Free	Stop	Stop
RT Channelized	-	None	-	None	-	None
Storage Length	-	-	-	-	0	-
Veh in Median Storage, #	0	-	-	0	0	-
Grade, %	0	-	-	0	0	-
Peak Hour Factor	92	92	92	92	92	92
Heavy Vehicles, %	2	2	2	2	2	2
Mvmt Flow	183	26	18	105	15	11

Major/Minor	Major1	Major2	Minor1		
Conflicting Flow All	0	0	209	0	337 196
Stage 1	-	-	-	-	196 -
Stage 2	-	-	-	-	141 -
Critical Hdwy	-	-	4.12	-	6.42 6.22
Critical Hdwy Stg 1	-	-	-	-	5.42 -
Critical Hdwy Stg 2	-	-	-	-	5.42 -
Follow-up Hdwy	-	-	2.218	-	3.518 3.318
Pot Cap-1 Maneuver	-	-	1362	-	658 845
Stage 1	-	-	-	-	837 -
Stage 2	-	-	-	-	886 -
Platoon blocked, %	-	-	-	-	-
Mov Cap-1 Maneuver	-	-	1362	-	649 845
Mov Cap-2 Maneuver	-	-	-	-	649 -
Stage 1	-	-	-	-	837 -
Stage 2	-	-	-	-	874 -

Approach	EB	WB	NB
HCM Control Delay, s	0	1.1	10.2
HCM LOS			B

Minor Lane/Major Mvmt	NBLn1	EBT	EBR	WBL	WBT
Capacity (veh/h)	718	-	-	1362	-
HCM Lane V/C Ratio	0.036	-	-	0.014	-
HCM Control Delay (s)	10.2	-	-	7.7	0
HCM Lane LOS	B	-	-	A	A
HCM 95th %tile Q(veh)	0.1	-	-	0	-

Intersection						
Int Delay, s/veh	4.5					
Movement	EBL	EBR	NBL	NBT	SBT	SBR
Lane Configurations	T			T		
Traffic Vol, veh/h	39	133	82	347	570	29
Future Vol, veh/h	39	133	82	347	570	29
Conflicting Peds, #/hr	0	0	0	0	0	0
Sign Control	Stop	Stop	Free	Free	Free	Free
RT Channelized	-	None	-	None	-	None
Storage Length	0	-	-	-	-	-
Veh in Median Storage, #	0	-	-	0	0	-
Grade, %	0	-	-	0	0	-
Peak Hour Factor	92	92	92	92	92	92
Heavy Vehicles, %	2	2	2	2	2	5
Mvmt Flow	42	145	89	377	620	32

Major/Minor	Minor2	Major1	Major2			
Conflicting Flow All	1191	636	652	0	-	0
Stage 1	636	-	-	-	-	-
Stage 2	555	-	-	-	-	-
Critical Hdwy	6.42	6.22	4.12	-	-	-
Critical Hdwy Stg 1	5.42	-	-	-	-	-
Critical Hdwy Stg 2	5.42	-	-	-	-	-
Follow-up Hdwy	3.518	3.318	2.218	-	-	-
Pot Cap-1 Maneuver	207	478	935	-	-	-
Stage 1	527	-	-	-	-	-
Stage 2	575	-	-	-	-	-
Platoon blocked, %				-	-	-
Mov Cap-1 Maneuver	182	478	935	-	-	-
Mov Cap-2 Maneuver	182	-	-	-	-	-
Stage 1	464	-	-	-	-	-
Stage 2	575	-	-	-	-	-

Approach	EB	NB	SB
HCM Control Delay, s	26.6	1.8	0
HCM LOS	D		

Minor Lane/Major Mvmt	NBL	NBT	EBLn1	SBT	SBR
Capacity (veh/h)	935	-	349	-	-
HCM Lane V/C Ratio	0.095	-	0.536	-	-
HCM Control Delay (s)	9.3	0	26.6	-	-
HCM Lane LOS	A	A	D	-	-
HCM 95th %tile Q(veh)	0.3	-	3	-	-

Intersection						
Int Delay, s/veh	1					
Movement	EBL	EBR	NBL	NBT	SBT	SBR
Lane Configurations	T			T		T
Traffic Vol, veh/h	10	27	41	413	684	14
Future Vol, veh/h	10	27	41	413	684	14
Conflicting Peds, #/hr	0	0	0	0	0	0
Sign Control	Stop	Stop	Free	Free	Free	Free
RT Channelized	-	None	-	None	-	None
Storage Length	0	-	-	-	-	-
Veh in Median Storage, #	0	-	-	0	0	-
Grade, %	0	-	-	0	0	-
Peak Hour Factor	89	89	89	89	89	89
Heavy Vehicles, %	2	2	2	2	2	2
Mvmt Flow	11	30	46	464	769	16

Major/Minor	Minor2	Major1	Major2			
Conflicting Flow All	1333	777	785	0	-	0
Stage 1	777	-	-	-	-	-
Stage 2	556	-	-	-	-	-
Critical Hdwy	6.42	6.22	4.12	-	-	-
Critical Hdwy Stg 1	5.42	-	-	-	-	-
Critical Hdwy Stg 2	5.42	-	-	-	-	-
Follow-up Hdwy	3.518	3.318	2.218	-	-	-
Pot Cap-1 Maneuver	170	397	834	-	-	-
Stage 1	453	-	-	-	-	-
Stage 2	574	-	-	-	-	-
Platoon blocked, %				-	-	-
Mov Cap-1 Maneuver	157	397	834	-	-	-
Mov Cap-2 Maneuver	157	-	-	-	-	-
Stage 1	419	-	-	-	-	-
Stage 2	574	-	-	-	-	-

Approach	EB	NB	SB
HCM Control Delay, s	20	0.9	0
HCM LOS	C		

Minor Lane/Major Mvmt	NBL	NBT	EBLn1	SBT	SBR
Capacity (veh/h)	834	-	281	-	-
HCM Lane V/C Ratio	0.055	-	0.148	-	-
HCM Control Delay (s)	9.6	0	20	-	-
HCM Lane LOS	A	A	C	-	-
HCM 95th %tile Q(veh)	0.2	-	0.5	-	-

HCM 6th Signalized Intersection Summary
5: Rays Rd & Memorial Dr

Spivey Lake Residential
Build PM

Movement	EBU	EBL	EBT	EBR	WBU	WBL	WBT	WBR	NBL	NBT	NBR	SBL
Lane Configurations		2T	3T	T		2T	3T	T	T	2T		2T
Traffic Volume (veh/h)	10	227	1456	77	15	42	1228	154	65	97	44	194
Future Volume (veh/h)	10	227	1456	77	15	42	1228	154	65	97	44	194
Initial Q (Qb), veh		0	0	0		0	0	0	0	0	0	0
Ped-Bike Adj(A_pbT)		1.00		1.00		1.00		1.00	1.00		1.00	1.00
Parking Bus, Adj		1.00	1.00	1.00		1.00	1.00	1.00	1.00	1.00	1.00	1.00
Work Zone On Approach			No				No			No		
Adj Sat Flow, veh/h/ln		1870	1870	1870		1870	1870	1870	1870	1870	1870	1870
Adj Flow Rate, veh/h		239	1533	0		44	1293	0	68	102	46	204
Peak Hour Factor		0.95	0.95	0.95		0.95	0.95	0.95	0.95	0.95	0.95	0.95
Percent Heavy Veh, %		2	2	2		2	2	2	2	2	2	2
Cap, veh/h		309	1981			118	1699		366	662	283	272
Arrive On Green		0.09	0.39	0.00		0.03	0.33	0.00	0.04	0.27	0.27	0.08
Sat Flow, veh/h		3456	5106	1585		3456	5106	1585	1781	2425	1036	3456
Grp Volume(v), veh/h		239	1533	0		44	1293	0	68	73	75	204
Grp Sat Flow(s),veh/h/ln		1728	1702	1585		1728	1702	1585	1781	1777	1684	1728
Q Serve(g_s), s		7.2	27.9	0.0		1.3	24.0	0.0	2.9	3.3	3.6	6.1
Cycle Q Clear(g_c), s		7.2	27.9	0.0		1.3	24.0	0.0	2.9	3.3	3.6	6.1
Prop In Lane		1.00		1.00		1.00		1.00	1.00		0.62	1.00
Lane Grp Cap(c), veh/h		309	1981			118	1699		366	485	460	272
V/C Ratio(X)		0.77	0.77			0.37	0.76		0.19	0.15	0.16	0.75
Avail Cap(c_a), veh/h		456	2549			163	2116		377	485	460	391
HCM Platoon Ratio		1.00	1.00	1.00		1.00	1.00	1.00	1.00	1.00	1.00	1.00
Upstream Filter(I)		1.00	1.00	0.00		1.00	1.00	0.00	1.00	1.00	1.00	1.00
Uniform Delay (d), s/veh		47.3	28.4	0.0		50.1	31.6	0.0	26.0	29.3	29.4	47.9
Incr Delay (d2), s/veh		4.8	1.2	0.0		1.9	1.3	0.0	0.2	0.7	0.8	4.8
Initial Q Delay(d3),s/veh		0.0	0.0	0.0		0.0	0.0	0.0	0.0	0.0	0.0	0.0
%ile BackOfQ(50%),veh/ln		3.2	10.8	0.0		0.6	9.5	0.0	1.2	1.5	1.5	2.8
Unsig. Movement Delay, s/veh												
LnGrp Delay(d),s/veh		52.1	29.6	0.0		52.1	32.9	0.0	26.2	29.9	30.1	52.7
LnGrp LOS		D	C			D	C		C	C	C	D
Approach Vol, veh/h			1772	A			1337	A		216		
Approach Delay, s/veh			32.6				33.6			28.8		
Approach LOS			C				C			C		
Timer - Assigned Phs	1	2	3	4	5	6	7	8				
Phs Duration (G+Y+Rc), s	15.5	41.3	10.3	39.0	9.6	47.2	14.3	35.0				
Change Period (Y+Rc), s	6.0	6.0	6.0	6.0	6.0	6.0	6.0	6.0				
Max Green Setting (Gmax), s	14.0	44.0	5.0	33.0	5.0	53.0	12.0	26.0				
Max Q Clear Time (g_c+I1), s	9.2	26.0	4.9	23.7	3.3	29.9	8.1	5.6				
Green Ext Time (p_c), s	0.3	8.2	0.0	1.8	0.0	11.3	0.2	0.7				

Intersection Summary												
HCM 6th Ctrl Delay			34.3									
HCM 6th LOS			C									

Notes
User approved ignoring U-Turning movement.
Unsignalized Delay for [EBR, WBR] is excluded from calculations of the approach delay and intersection delay.

HCM 6th Signalized Intersection Summary
5: Rays Rd & Memorial Dr

Spivey Lake Residential
Build PM



Movement	SBT	SBR
Lane Configurations	↑↑	↑
Traffic Volume (veh/h)	199	344
Future Volume (veh/h)	199	344
Initial Q (Qb), veh	0	0
Ped-Bike Adj(A_pbT)		1.00
Parking Bus, Adj	1.00	1.00
Work Zone On Approach	No	
Adj Sat Flow, veh/h/ln	1870	1870
Adj Flow Rate, veh/h	209	362
Peak Hour Factor	0.95	0.95
Percent Heavy Veh, %	2	2
Cap, veh/h	1105	493
Arrive On Green	0.31	0.31
Sat Flow, veh/h	3554	1585
Grp Volume(v), veh/h	209	362
Grp Sat Flow(s),veh/h/ln	1777	1585
Q Serve(g_s), s	4.6	21.7
Cycle Q Clear(g_c), s	4.6	21.7
Prop In Lane		1.00
Lane Grp Cap(c), veh/h	1105	493
V/C Ratio(X)	0.19	0.73
Avail Cap(c_a), veh/h	1105	493
HCM Platoon Ratio	1.00	1.00
Upstream Filter(l)	1.00	1.00
Uniform Delay (d), s/veh	26.8	32.7
Incr Delay (d2), s/veh	0.4	9.4
Initial Q Delay(d3),s/veh	0.0	0.0
%ile BackOfQ(50%),veh/ln	2.0	9.4
Unsig. Movement Delay, s/veh		
LnGrp Delay(d),s/veh	27.2	42.0
LnGrp LOS	C	D
Approach Vol, veh/h	775	
Approach Delay, s/veh	40.8	
Approach LOS	D	
Timer - Assigned Phs		

APPENDIX D: TURN LANE EVALUATIONS

GDOT Access Manual Turn Lane Evaluations

ID	Intersection	Movement/ Turn Lane	GDOT Criteria met?	AADT (Norman Rd): < 6,000 Trip Dist. Volume			
1	Driveway 1 / Otello Rd & Norman Rd	WBL	NO	LTV	4%	37	> 300
		EBR	NO	RTV	8%	74	> 200
2	Driveway 2 & Norman Rd	WBL	NO	LTV	18%	166	> 300
		EBR	YES	RTV	26%	240	> 200
4	Rays Rd & Spartan Ln	NBL	NO	LTV	31%	286	> 300
		SBR	NO	RTV	13%	120	> 200

		IN	OUT
Daily	1,844	922	922
AM Peak Hour	121	28	93
PM Peak Hour	147	92	55

APPENDIX E: TECHNICAL MEMORANDUM

TECHINCAL MEMO

To: Davis Moore, Mosaic Communities
 From: Naveed Jaffar, PE, PTOE
 Date: April 27, 2021
 Re: Spivey Lake Residential Development, DeKalb County, Georgia

NV5 Engineers & Consultants, Inc. completed a traffic impact study in April 2021 for the proposed Spivey Lake Residential Development along Norman Road in DeKalb County, Georgia. This memorandum serves as a supplement to the completed traffic study in order to provide the hourly distribution of expected generated trips to and from the development. This memorandum also serves to explore the potential trip reduction for multi-modal and transit impacts.

Trip Generation – Hourly Trip Generation

The proposed development will consist of 40 single family homes, 138 two-family homes, and 52 townhomes. The development has a projected build out date of 2024 and will generate a total of 1,844 new daily trips. Of these daily volumes, 121 (28 entering and 93 exiting) are expected to occur in the AM peak hour while 147 (92 entering and 55 exiting) are expected to occur in the PM peak hour. Table 1 depicts the total expected Trip Generation for the development.

Table 1. Complete Trip Generation

LAND USE	PERIOD	TOTAL	IN	OUT
Single Family Homes, LUC 210 (40 Dwelling Units)	Daily	448	224	224
	AM Peak Hour	33	8	25
	PM Peak Hour	42	26	16
*Two/Three Family Homes (190 Dwelling Units - 138 Two-Family Homes, 52 Townhomes)	Daily	1,396	698	698
	AM Peak Hour	88	20	68
	PM Peak Hour	105	66	39
Total Net Trips	Daily	1,844	922	922
	AM Peak Hour	121	28	93
	PM Peak Hour	147	92	55

*Study utilizes ITE (Institute of Transportation Engineers) Land Use Code *Multi-Family Housing Low-Rise (LUC 220)*

The hourly trip generation was developed using the ITE (Institute of Transportation Engineers') methodology. From the hourly trip generation, we can expect on average for there to be one (1) vehicle every 0.8 minutes (46 seconds) throughout the day. Table 2 depicts the estimated number of generated trips expected every hour of the day and the frequency.

Table 2. Estimated Hourly Trip Generation – Trip Generation Rate

Beginning Hour	Expected Trips	
	Total	Vehicle Every (X) Minutes
12:00 AM	14	4.2
1:00 AM	8	7.6
2:00 AM	8	7.4
3:00 AM	9	6.5
4:00 AM	15	4.0
5:00 AM	33	1.8
6:00 AM	69	0.9
7:00 AM	118	0.5
8:00 AM	111	0.5
9:00 AM	97	0.6
10:00 AM	82	0.7
11:00 AM	96	0.6
12:00 PM	102	0.6
1:00 PM	94	0.6
2:00 PM	106	0.6
3:00 PM	127	0.5
4:00 PM	139	0.4
5:00 PM	149	0.4
6:00 PM	137	0.4
7:00 PM	110	0.5
8:00 PM	89	0.7
9:00 PM	66	0.9
10:00 PM	37	1.6
11:00 PM	28	2.2
Total	1,844	0.8

Table 3 depicts the expected number of trips that will utilize Norman Road, Rays Road, and Spartan Lane during each hour of the day. The planned traffic calming measures are likely to discourage travel along Othello Avenue. Therefore, there is not a significant amount of traffic from the development expected to utilize Othello Avenue. Supporting worksheets for computations are attached. The hourly breakdown by movement for each of the access points of the development is also attached.

Table 3. Estimated Hourly Roadway Trips

Beginning Hour	Norman Road b/w Othello Ave and Rays Road		Rays Road b/w Norman Road and Spartan Lane		Spartan Lane b/w subject development and Rays Road	
	Eastbound	Westbound	Northbound	Southbound	Eastbound	Westbound
12:00 AM	4	4	5	4	2	4
1:00 AM	2	2	3	2	1	2
2:00 AM	2	2	2	3	2	2
3:00 AM	3	3	3	3	2	2
4:00 AM	4	5	4	6	4	2
5:00 AM	8	10	7	13	11	3
6:00 AM	17	22	13	29	25	5
7:00 AM	29	37	25	47	40	12
8:00 AM	28	34	24	43	36	12
9:00 AM	25	29	25	34	27	15
10:00 AM	22	24	24	27	20	16
11:00 AM	27	27	29	30	22	20
12:00 PM	29	28	31	31	22	23
1:00 PM	26	26	29	29	21	21
2:00 PM	30	29	34	31	21	25
3:00 PM	37	34	43	34	22	34
4:00 PM	41	37	48	36	23	38
5:00 PM	44	40	52	39	25	41
6:00 PM	41	36	48	36	22	38
7:00 PM	32	30	37	31	21	28
8:00 PM	26	24	31	23	14	25
9:00 PM	20	17	24	17	10	19
10:00 PM	11	10	14	9	5	11
11:00 PM	8	7	11	6	3	9
TOTAL	516	516	563	563	406	406

Trip Reduction

NV5 Engineers & Consultants has developed a potential trip reduction factor that could possibly be used to reduce the number of trips generated by the development. The factor considers the area use of transit, transit availability, pedestrian connection to transit facilities and nearby land uses, and site-specific characteristics. From the data and methodology used, a reduction factor of 0.90 was developed. The trip reduction worksheet is attached.

ATTACHMENTS

Access Point 1

2024 Build Traffic Counts - All Vehicles																				
Time (Hr Beg.)	Norman Road					Norman Road					North Access Point 1					Othello Avenue				
	Eastbound					Westbound					Northbound					Southbound				
	U-Turn	Left	Thru	Right	RTOR	U-Turn	Left	Thru	Right	RTOR	U-Turn	Left	Thru	Right	RTOR	U-Turn	Left	Thru	Right	RTOR
12:00 AM			1				0					0		0						
1:00 AM			0				0					0		0						
2:00 AM			0				0					0		0						
3:00 AM			0				0					0		0						
4:00 AM			0				0					1		0						
5:00 AM			1				0					2		1						
6:00 AM			1				0					5		2						
7:00 AM			2				1					7		4						
8:00 AM			2				1					7		3						
9:00 AM			3				1					5		2						
10:00 AM			3				1					4		2						
11:00 AM			4				2					4		2						
12:00 PM			4				2					4		2						
1:00 PM			4				2					4		2						
2:00 PM			5				2					4		2						
3:00 PM			6				3					4		2						
4:00 PM			7				3					4		2						
5:00 PM			7				4					5		2						
6:00 PM			7				3					4		2						
7:00 PM			5				3					4		2						
8:00 PM			5				2					3		1						
9:00 PM			3				2					2		1						
10:00 PM			2				1					1		0						
11:00 PM			2				1					1		0						
TOTAL			74				37					74		37						



Access Point 2

2024 Build Traffic Counts - All Vehicles																				
Time (Hr Beg.)	Norman Road					Norman Road					North Access Point 2					Southbound				
	Eastbound					Westbound					Northbound									
	U-Turn	Left	Thru	Right	RTOR	U-Turn	Left	Thru	Right	RTOR	U-Turn	Left	Thru	Right	RTOR	U-Turn	Left	Thru	Right	RTOR
12:00 AM			0	2			2	0				1		1						
1:00 AM			0	1			1	0				1		1						
2:00 AM			0	1			1	0				1		1						
3:00 AM			0	1			1	0				1		1						
4:00 AM			0	1			1	0				3		2						
5:00 AM			1	2			1	0				7		5						
6:00 AM			2	3			2	0				15		10						
7:00 AM			4	7			5	1				24		16						
8:00 AM			3	7			5	1				22		15						
9:00 AM			2	9			6	1				16		11						
10:00 AM			2	10			7	1				12		8						
11:00 AM			2	12			8	2				13		9						
12:00 PM			2	13			9	2				13		9						
1:00 PM			2	12			8	2				12		9						
2:00 PM			2	15			10	2				13		9						
3:00 PM			2	20			14	3				13		9						
4:00 PM			2	22			16	3				14		9						
5:00 PM			2	24			17	4				15		10						
6:00 PM			2	22			16	3				13		9						
7:00 PM			2	16			11	3				12		8						
8:00 PM			1	15			10	2				9		6						
9:00 PM			1	11			8	2				6		4						
10:00 PM			0	7			5	1				3		2						
11:00 PM			0	5			4	1				2		1						
TOTAL			37	240			166	37				240		166						



Access Point 3

2024 Build Traffic Counts - All Vehicles																				
Time (Hr Beg.)	Spartan Lane					Rays Road					Rays Road									
	Eastbound					Westbound					Northbound					Southbound				
	U-Turn	Left	Thru	Right	RTOR	U-Turn	Left	Thru	Right	RTOR	U-Turn	Left	Thru	Right	RTOR	U-Turn	Left	Thru	Right	RTOR
12:00 AM		1		2								3	1					1	1	
1:00 AM		0		1								1	1					1	1	
2:00 AM		1		1								1	1					1	1	
3:00 AM		1		2								1	1					1	1	
4:00 AM		1		3								2	1					2	1	
5:00 AM		3		8								2	1					4	1	
6:00 AM		8		18								3	2					10	1	
7:00 AM		12		28								8	5					15	4	
8:00 AM		11		26								9	5					14	4	
9:00 AM		8		19								11	6					11	4	
10:00 AM		6		14								11	6					8	5	
11:00 AM		6		15								14	8					8	6	
12:00 PM		7		16								16	9					9	7	
1:00 PM		6		15								15	8					8	6	
2:00 PM		6		15								18	10					8	7	
3:00 PM		6		15								24	13					8	10	
4:00 PM		7		16								27	15					9	11	
5:00 PM		7		18								29	16					10	12	
6:00 PM		7		16								27	15					9	11	
7:00 PM		6		14								20	11					8	8	
8:00 PM		4		10								18	10					6	7	
9:00 PM		3		7								13	7					4	6	
10:00 PM		2		4								8	4					2	3	
11:00 PM		1		2								6	3					1	3	
TOTAL		120		286								286	157					157	120	



Transit and Carpool Evaluation Tool

4069 Norman Road, Stone Mountain, Georgia 30083

Spivey Lake Residential

Date: 4/21/2021

Prepared by: M. Early



Trip Reduction Factor: 0.90
 Parking Reduction Factor: N/A

Transit Summary

Local Fixed-Route Bus; GOOD arrival times; SOMEWHAT CLOSE; ADEQUATE ped access; ALL can use

Transit is Available to **100%**
of Residents

Influence of Available Transit 90.0%
 Area Transit Usage 16.4%
 Area Carpool Usage 9.5%
 Area Bike/Ped Activity 1.5%

Source: American Community Survey, 2018

Comments:

MARTA bus route 121 - Memorial Drive/N. Hairston Road (nearest transit to development); walk to closest transit stop, 0.63 - 1.05 miles; Transect Development character rating, T4; Pedestrian Connection, ADEQUATE- lack of sidewalk along Spartan Lane, consistent sidewalk to transit stops; TDM Strategy, IN PLACE - walking trails facilitating access to local roadway network

- Possible TDM Measures**
- Pre-Tax Incentives
 - Guaranteed Ride Home
 - Ride-Share / Carpool
 - Carpool Parking
 - Bike Facilities
 - Lockers
 - Informational Kiosks
 - Transportation Coordinators
 - Shuttle to Transit
 - Other (Specify)

Site Image:



Pedestrian connections are categorized as follows.

Pedestrian Connection	
Site to Transit Stop/Stn	Rating
Complete	Excellent
Partial-Mitigatable	Adequate
Partial-Non-Mitigatable	Poor
Not an Influencing Factor	Non-Relevant
None	No

Explanation of Rating

Excellent. An unbroken/unobstructed sidewalk or formal walking path from the site to the transit stop/station, providing a safe travel route.

Adequate. A broken/obstructed sidewalk or formal walking path from the site to the transit stop/station, which can be mitigated, and traveler movement and safety are minimally impacted

Poor. An unsafe and/or uncomfortable pedestrian travel environment between the site and the transit stop/station that cannot be mitigated.

Non-relevant. Access to transit stop/station from the site is not impacted by the presence, or lack thereof, of a formal pedestrian connection.

Proprietary to NV5, Inc.