

Public Hearing: YES NO

Department: Planning & Sustainability

SUBJECT:

COMMISSION DISTRICT(S): 2 & 6

Application of David Kirk to request a Special Land Use Permit (SLUP) to allow a drive through facility in Town Center Character Area, at 3795 North Druid Hills Road.

PETITION NO: N2. SLUP-21-1244886 (2021-2639)

PROPOSED USE: Drive through facility.

LOCATION: 3795 North Druid Hills Road.

PARCEL NO. : 18-100-04-019

INFO. CONTACT: Dustin Jackson, Sr. Planner

PHONE NUMBER: 404-371-6283

PURPOSE:

Application of David Kirk to request a Special Land Use Permit (SLUP) to allow a drive through facility in Town Center Character Area. The property is located on the southeast corner of North Druid Hills Road and Birch Road, at 3795 North Druid Hills Road, Decatur, GA. The property has 233 feet of frontage on North Druid Hills Road and 198 feet of frontage on Birch Road and contains 1.04 acres.

RECOMMENDATION:

COMMUNITY COUNCIL: Approval.

PLANNING COMMISSION: Pending.

PLANNING STAFF: Full Cycle Deferral.

STAFF ANALYSIS: Based on the applicant's willingness to make strides to blend aspects of the TC activity center policies and the need for concise guidance on the vision for the subject property, the Department of Planning and Sustainability recommends "Full Cycle Deferral". Additionally, the deferral would permit the applicant to redesign the proposal for compliance with the *Zoning Ordinance*. However, if the Planning Commission recommends approval, the Department of Planning and Sustainability recommends the attached conditions:

PLANNING COMMISSION VOTE: Pending.

COMMUNITY COUNCIL VOTE/RECOMMENDATION: Approval 8-1-1.

SLUP-21-1244886
Recommended Conditions

1. The subject property shall be developed in substantial conformity with the following site plans: "Variance Site Plan", prepared by Bohler, dated 04-29-2021 and with the building elevation attached to the SLUP application.
2. The applicant shall perform a traffic impact analysis and incorporate any recommended site improvements or directly adjacent right-of-way improvements, as approved by the Georgia Department of Transportation or DeKalb County.
3. The applicant shall install or contribute full costs for the installation of a left turn lane on N. Druid Hills Road at Birch Road.
4. No exterior sound systems, outdoor speakers, or sound amplification systems are permitted.
5. The Special Land Use Permit shall be issued to Midtown National Group, LP for a Chik-Fil-A drive-through restaurant only and shall not be transferrable for the purposes of establishing any other drive-through establishment.
6. The approval of this Special Land Use application by the Board of Commissioners has no bearing on the requirements for other regulatory approvals under the authority of the Zoning Board of Appeals, or other entities whose decision should be based on the merits of the application under review by such entity.
7. Truck loading/delivery shall not impede internal circulation on-site.
8. The applicant shall install adequate internal signage. Illustrations and design specifications for internal signage must be provided prior to land development phase approval.
9. If the restaurant partners with meal delivery service providers (e.g. Door Dash, Uber Eats, etc.), a portion of the excess parking spaces for passenger vehicles shall be designated for those meal delivery service providers.



DeKalb County Department of Planning & Sustainability

**330 Ponce De Leon Avenue, Suite 500
Decatur, GA 30030
(404) 371-2155 / plandev@dekalbcountyga.gov**

Michael Thurmond
Chief Executive Officer

**Planning Commission Hearing Date: July 8, 2021
Board of Commissioners Hearing Date: July 29th, 2021**

STAFF ANALYSIS

Case No.: SLUP-21-1244886 **Agenda #:** N2

Location/Address: 3795 North Druid Hills Road, Decatur, GA 30033 **Commission District:** 02 **Super District:** 06

Parcel ID: 18-100-04-019

Request: Special Land Use Permit (SLUP) request to allow for a drive-through restaurant.

Property Owner(s): Midtown National Group, LP

Applicant/Agent: David Kirk, on behalf of Chick-Fil-A, Inc.

Acreage: 1.04 acres

Existing Land Use: Retail Commercial

Surrounding Properties: To the north of the subject property is North Druid Hills Road, to the south is North DeKalb Mall, west is commercial, and to the east is commercial.

Adjacent Zoning: North: R75, O-I South: C-1 East: C-1 West: C-1

Comprehensive Plan: Town Center (TC) Consistent Inconsistent

Proposed Density: N.A.	Existing Density: N.A.
Proposed Square Ft.: 2,800 Sq. Ft.	Existing Units/Square Feet: N.A.
Proposed Lot Coverage: 6.14%	Existing Lot Coverage: N.A.

Subject Property and Surrounding Area

The subject property is a 1.04 acre site located on the south side of North Druid Hills Road bordering the north side of the North DeKalb Mall. An on-ramp to I-285 is located approximately 1,700 feet to the east of Lawrenceville Highway (Highway 78). The property is currently occupied by a vacant commercial retail establishment; formerly a Pier 1 Imports store. The adjoining and nearby land uses to the east, south, and west are commercial uses zoned C-1 and NS. The adjoining and nearby land uses to the north are mix of residential and commercial uses zoned R-75 and O-I. The commercial uses to the east of the subject property and fronting on North Druid Hills Road consist of four drive-through restaurants (Zaxby's, McDonalds, Chick-fil-A, and Checkers). Also, to the east of the subject property, uses include an existing dry-cleaners, auto repair shop, liquor store, gas station, and jeweler. There is also an existing 3-story commercial building that appears to have Class C office space with various existing businesses which include a store front church, hair salon, and a driving school. West of the subject property are two existing one story buildings home to Peachtree Spine Physicians as well as a pet hospital. South of the subject property is an undeveloped lot and North Dekalb Mall. It is important to note that the mall technically closed in 2020, however, there are a few stores, a U.S. Postal Service branch, and an AMC movie theatre still operating along perimeter of the physical mall site. To the north of the subject property, is a mix of residential and commercial uses. The residential uses are mostly located in the North Druid Woods neighborhood. It is a modest neighborhood consisting of one store ranch style homes. Office residential uses along this portion of the corridor consist of a holistic health center, auto insurance office, a dry cleaners, travel agents office, massage therapist, and chiropractor.

Zoning History

Based on DeKalb County records, it appears that the NS (Neighborhood Shopping) zoning of the property has not changed since adoption of the first zoning ordinance and map in 1956. The *DeKalb County 2035 Comprehensive Plan* designates the subject property's future land use as Town Center (TC).

Project Analysis

The applicant is requesting to rezone the subject property from NS (Neighborhood Shopping) to C-1 (Local Commercial) for the purpose of constructing a drive-through restaurant. The applicant's request proposes the relocation of the Chick-fil-A restaurant from 3905 N. Druid Hills Road to the subject property. Based on the site plan provided by the applicant, the construction of the 2,800 square foot drive through restaurant will require the demolition of the vacant one-story building which was a furniture and home essentials retail establishment (Pier 1 Imports). The project will make use of the two existing connections to Birch Road and North Druid Hills Road. These connections will serve as both entrances and exits for customers. The North Druid Hills access will serve as a right-in/right-out only. The drive-through restaurant will consist of three drive-through lanes that merge into two lanes as they approach the drive through service area, which will permit servers to walk food out instead of using a drive-through window. The redeveloped site is proposed to accommodate vehicular stacking for 41 cars and include 29 parking spaces, of which, two will be designated for patrons with disabilities. The restaurant will also have outdoor seating for customers on the east side of the building. Additionally, the developer intends to install a variety of trees and shrubs around the site to beautify it and buffer some of the vehicular activity.

COMPLIANCE WITH DISTRICT STANDARDS

STANDARD	REQUIREMENT	PROPOSED	COMPLIANCE
MAX LOT COVERAGE	90%	69.3%	Yes
BUILDING MATERIALS	Brick, stone, stucco, architectural concrete, glass.	Mostly brick.	Yes.
FRONT BUILDING SETBACK	10ft min/60ft max	> 10ft.	YES
SIDE – CORNER LOT ON PUBLIC STREETS SETBACK	30ft.	< 30ft.	NO (variance needed)
SIDE INTERIOR BUILDING SETBACK	15 Feet	> 15ft.	Yes
REAR BUILDING SETBACK	20 Feet	> 20ft.	YES
HEIGHT	2 stories/35 feet	1 story/21 feet	Yes
PARKING	1:150sf (min)= 19 spaces 1:75sf (max) = 37 spaces	29 parking spaces	Yes
PARKING CONFIGURATION	Non-residential buildings in an Activity Center shall have no more than one (1) double row of parking within the front yard where there is no intervening building between parking and the street.	No parking is proposed in the front yard. All paking is on side and in back.	Yes

PARKING CONFIGURATION	Non-residential buildings in an Activity Center shall be allowed to locate parking along the side or rear or as on-street parking dedicated as right-of-way by the applicant for a land disturbance permit or building permit.	Parking is located to the side and rear of the building.	Yes
OPEN SPACE	10%	30.6%	Yes
SIDEWALKS AND STREETSCAPING	6-ft. sidewalk, 10-ft. landscape strip, street trees 40 ft. on center (N. Druid Hills Rd.) 6-ft. sidewalk, 6-ft. landscape strip, street trees 50 ft. on center (Birch Rd.)	8ft (2ft near the curb; 6ft into the site; Yes	No. However, adjustments may be made pending GDOT, County Public Works, or ZBA variances Yes

Impact Analysis

Section 27-7.4.6 of the DeKalb County Code states that the following criteria shall be applied in evaluating and deciding any application for a Special Land Use Permit.

- A. Adequacy of the size of the site for the use contemplated and whether or not adequate land area is available for the proposed use including provision of all required yards, open space, off-street parking, and all other applicable requirements of the zoning district in which the use is proposed to be located.**

Located on 1.04 acres, adequate land area is available to operate a restaurant with a drive-through lane and comply with all required yards, open space, and off-street parking required within the C-1 (Local Commercial) Zoning District. However, the site plan does not comply with the minimum setbacks required in the C-1 zoning designation.

The complexity of this proposal is a conflict of aspirational versus practical; future versus present. The subject property is located in the Town Center (TC) activity center future land use designation. The intent of the Town Center character area is “to promote the concentration of residential and commercial structures, which serve many communities in order to reduce automobile travel, promote walkability and increased transit usage. The areas consist of a focal point for several neighborhoods with a variety of activities such as general retail, commercial, professional office, higher-density housing, and

appropriate public and open space uses that are easily accessible by pedestrians.” Associated planning principles that are envisioned in this activity center include: pedestrian-friendly design, mixed-use development, greater density of development, taller development, and parking at the rear of building among others. Therefore, the applicant proposes to situate the new building closer to the N. Druid Hills Road along with installation of parking and drive-thru facilities to the side and/or rear. However, it is important to note that the subject property sits on the outer edge of this TC activity center. Some of the preferred development standards apply more so at the core and taper off towards the outer edges. Additionally, since N. Druid Hills Road is a major arterial road, along this portion of the corridor, it may not be prudent to promote greater pedestrian activity within the corridor. Pedestrian facilities and gathering places may be more suitable internally between the properties along N. Druid Hills Road and North DeKalb Mall. While we desire a more pedestrian friendly environment overall for this activity center at its core, the parcels along North Druid Hills Road may be suitable for auto dependent uses.

However, if it is desired for the proposed building to sit closer to the improved sidewalk and streetscape, then the proposed façade does not include adequate fenestration to engage with potential pedestrians. The proposed north elevation appears to be relatively bare. It would not contribute to creation of a vibrant, pedestrian environment.

B. Compatibility of the proposed use with adjacent properties and land uses and with other properties and land uses in the district.

The proposed drive-through restaurant is consistent with the surrounding drive-through facilities in the area including a Zaxby’s drive-through restaurant directly adjacent to the subject property, a McDonalds drive-through, a Checkers drive-through and the existing Chick-fil-a drive-through. There is also a Chevron gas station and an auto repair shop nearby. All of these sites are east of the subject property along North Druid Hills Road. However, the reduction of automobile travel is preferred within the TC activity center.

C. Adequacy of public services, public facilities, and utilities to serve the proposed use.

Given that the area along North Druid Hills Road is developed with various commercial uses, it appears that there are adequate public services and utilities for the proposed drive-through restaurant.

D. Adequacy of the public street on which the use is proposed to be located and whether or not there is sufficient traffic-carrying capacity for the use proposed so as not to unduly increase traffic and create congestion in the area.

North Druid Hills Road is a major arterial. The County Transportation Division is requiring construction of a westbound left turn lane on North Druid Hills Road at Burch Road. From observation, left turns at this intersection are challenging once eastbound traffic on N. Druid Hills Road builds. A right in/right out ingress/egress is proposed, therefore, patrons approaching from the east will need that turn lane to more efficiently access the site from Birch Road. Addition of the left turn lane would improve the adequacy of the adjacent public streets.

E. Whether existing land uses located along access routes to the site will be adversely affected by the character of the vehicles or the volume of traffic generated by the proposed use.

Given the surrounding drive-through businesses, it does not appear that the character of the vehicles will adversely impact existing land uses along access routes to the site. Staff performed a site visit on June 16, 2021 at 1:30pm and traffic congestion was observed in both directions on North Druid Hills Road. Additionally, it was observed that the carrying capacity for the dedicated right turn lane on North Druid Hills Road adjacent to the subject property and Zaxby's may not be sufficient to accommodate right out traffic from the subject property and the full access ingress/egress at Zaxby's during peak hours, which may present some vehicular conflicts.

F. Adequacy of ingress and egress to the subject property and to all proposed buildings, structures, and uses thereon, with particular reference to pedestrian and automotive safety and convenience, traffic flow and control, and access in the event of fire or other emergency.

Two points of access are proposed. One point of access is on North Druid Hills Road (right in/right out only) and the other point of access (full access) is on Birch Road. Emergency vehicles can access the site from either point of ingress/egress. In addition to the observations in Criterion E, Zaxby's secondary ingress/egress is onto an access easement to its south which directs traffic to Birch Road and Sweet Briar Road adjacent to the North DeKalb Mall.

According to the site plan, internal circulation is centered on a "horseshoe" pattern to access three canopied drive-through lanes that narrow to two lanes for food delivery and parking around the perimeter of the site. Assuming the bulk of sales are via drive-through service, the proposed circulation plan may create a few issues: 1. the 2 parking spaces for disabled patrons are away from the building and close to the right in/right out access point at North Druid Hills Road; 2. in that vicinity drive-thru patrons who have received their food will also depart near the handicapped spaces and as patrons enter from North Druid Hills; 3. given the proposed layout, reasonable signage may be necessary to ensure internal circulation flows as intend.

Given the popularity of the proposed establishment, it may be more efficient and may lessen potential conflicts, if the applicant considers right in only from North Druid Hills Road, full access to/from Birch Road, and either a connection to the existing access easement to distribute traffic around the mall (where there are multiple controlled access intersections to North Druid Hills Road and Lawrenceville Highway) and/or install adequate signage to encourage drivers to take advantage of multiple ingress/egress points around the mall.

G. Whether the proposed use will create adverse impacts upon any adjoining land use by reason of noise, smoke, odor, dust, or vibration generated by the proposed use.

The proposed drive-through restaurant should not create adverse impacts upon any adjoining land use by reason of noise, smoke, odor, dust or vibration.

H. Whether the proposed use will create adverse impacts upon any adjoining land use by reason of the hours of operation of the proposed use.

The hours of operation for the proposed drive-through lane should not create adverse impacts upon adjoining land uses. The proposed use will not be a 24-hour establishment. It will operate on standard Chick-fil-a hours of operation.

I. Whether the proposed use will create adverse impacts upon any adjoining land use by reason of the manner of operation of the proposed use.

The manner of operation for the proposed drive-through lane could possibly impact the flow of traffic in an existing right turn lane that serves an existing Zaxby's drive-through restaurant. See criteria E and F also.

J. Whether the proposed use is otherwise consistent with the requirements of the zoning district classification in which the use is proposed to be located.

The applicant currently has a rezoning application on the agenda that requests a rezoning of the subject property from NS (Neighborhood Shopping) to C-1 (Local Commercial). As a preferred zoning district within the town center character area, it is implied that the C-1 zoning district and its collection of permissible principal and accessory uses are suitable; prohibited uses are not suitable; and that other uses are subject to special land use permit approval in order to evaluate the appropriateness of those uses based on impacts that may be unique depending on their settings. Drive-through lanes are permitted uses within the C-1 zoning district with an approved Special Land Use Permit (SLUP). While the proposed site plan complies with most of the C-1 zoning requirements, the building location would be subject to variance approval from the Zoning Board of Appeals because it would be within the required 30-foot side corner setback.

K. Whether the proposed use is consistent with the policies of the comprehensive plan.

The site is located within a Town Center Character Area designated by the *DeKalb County 2035 Comprehensive Plan*. See criterion A also.

Although a drive-through establishment is not the ideal use for this activity center, mitigating factors may include that the establishment is relocating about one-quarter of a mile away from its existing location within the activity center, and it would be located along a major arterial road. Because the subject property is located on the perimeter of the TC activity center, consideration should be given to striking an appropriate balance based on current conditions and future objectives for parcels with direct access to North Druid Hills Road such as shared access, inter-parcel connectivity, and fewer curb cuts until a major catalyst for change occurs at the core to set the baseline for surrounding concurrency.

L. Whether the proposed use provides for all required buffer zones and transitional buffer zones where required by the regulations of the zoning district in which the use is proposed to be located.

The proposed site does not abut any residential zoned properties. Therefore, buffer zones are not required.

M. Whether there is adequate provision of refuse and service areas.

Adequate refuse areas will be provided based on the submitted information by the applicant.

N. Whether the length of time for which the special land use permit is granted should be limited in duration.

There does not appear to be any compelling reasons for limiting the duration of the requested Special Land Use Permit.

O. Whether the size, scale and massing of proposed buildings are appropriate in relation to the size of the subject property and in relation to the size, scale and massing of adjacent and nearby lots and buildings.

The proposed one-story building would be compatible in size and massing with adjacent commercial buildings in the area.

P. Whether the proposed use will adversely affect historic buildings, sites, districts, or archaeological resources.

There are no known historic building, sites, districts or archeological resources in the immediate area that will be adversely effected by the proposed use.

Q. Whether the proposed use satisfies the requirements contained within the supplemental regulations for such special land use permit.

The proposed drive-through lane complies with most of the following supplemental regulations per Sec.27-4.2.23 of the DeKalb County Zoning Code:

- a. Drive-through facilities shall not be located within sixty feet of a residentially zoned property. *The nearest residential zoning is the R-75 zoning to the north approximately 90 feet away.*
- b. No drive-through facility shall be located on property less than ten thousand square feet in area, unless part of a mixed-use development. Stacking spaces for queuing of cars shall be provided for the drive-through area as required in Article 6. All driveway entrances, including stacking lane entrances, must be at least fifty (50) feet from an intersection. The distance is measured along the street from the junction of the two street curb lines to the nearest edge of the entrance. *The property is 45,302 square feet (1.04 acres) in size. Forty-one stacking spaces are provided. The nearest intersection is at North Druid Hills Road and Birch Road. The North Druid Hills entrance is located about 100 feet from the intersection and the Birch Road entrance is located about 130 feet from the intersection.*
- c. Drive-through lanes and service windows serving drive-through lanes shall only be located to the side or rear of buildings. *The proposed drive through lanes and one service window are located to the rear of the proposed building.*
- d. Drive-through canopies and other structures, where present, shall be constructed from the same materials as the primary building and with a similar level of architectural quality and detailing. *Per submitted plans, it appears that the canopies will be constructed with the same materials as the building.*
- e. Speaker boxes shall be pointed away from any adjacent residential properties and shall require masonry sound attenuation walls with landscaping or other speaker volume mitigation measures. Speaker boxes shall not play music but shall only be used for communication for placing orders. *Per the submitted plans the speaker boxes will be positioned so that they are not interfering with residential uses.*

- f. All lighting from drive-through facilities shall be shaded and screened so as to be directed away from any adjacent residential property. *No lighting or photometric plan was submitted.*
- g. Stacking spaces shall be provided for any use having a drive-through facility or areas having drop-off and pick-up areas in accordance with the following requirements. Stacking spaces shall be a minimum of ten (10) feet wide and twenty-five (25) feet long. Stacking spaces shall begin at the last service window for the drive-through lane (typically the “pick-up” window). *Per the submitted preliminary site plan the staking spaces are 11.5’ wide and meet the 25’ minimum in length.*
- h. All drive-through facilities with the exception of drive-through restaurants shall provide at least three stacking spaces for each window or drive-through service facility. *Per the submitted preliminary site plan there are 41 car stacking spaces are provided.*
- i. The following standards shall apply to all stacking spaces and drive-through facilities:
 - i. Drive-through lanes shall not impede on- and off-site traffic movements, shall not cross or pass through off-street parking areas, and shall not create unsafe conditions where crossed by pedestrian access to a public entrance of a building. *The proposed drive-through lane as currently designed might cause internal circulation issues that could affect traffic both on-site and off-site. These circulation issues might also interfere with pedestrians going to and from the handicapped spaces.*
 - ii. Drive-through lanes shall be separated by striping or curbing from off-street parking areas. Individual lanes shall be striped, marked, or otherwise distinctly delineated. *Based on the submitted preliminary site plan there appears to be striping and material delineation shown to separate lanes.*
 - iii. All drive-through facilities shall include a bypass lane with a minimum width of ten (10) feet, by which traffic may navigate around the drive-through facility without traveling in the drive-through lane. The bypass lane may share space with a parking access aisle. *A by-pass lane does not appear to be shown on the site plan.*
 - iv. Drive-through lanes must be set back five (5) feet from all lot lines and roadway right-of-way lines. *The proposed drive-through lane is at least 15 feet away from all property lines and roadway right-of-way lines.*
 - v. Owner and operator are responsible for daily litter clean-up to ensure the property remains free of trash, litter, and debris. *The owner and operator shall be responsible for daily litter clean-up to ensure the property remains free of trash, litter, and debris.*
 - vi. Drive-through restaurants shall not be located within five hundred (500) feet of an elementary, middle, or high school. *Per DeKalb County’s GIS data it appears that the proposed drive-through restaurant is a least 1,000 feet from an existing school to the northeast.*
 - vii. Drive-through restaurants located in activity centers require a special land use permit. In all other character areas, a special land use permit is required unless the facility can meet at least two of the following criteria: a. Facility is located within four hundred (400) feet of an intersection of a major arterial street and a major or minor arterial street, or within one thousand (1,000) feet of an interstate highway interchange. b. Facility is accessible only through inter-parcel access or through a shared driveway. c. Facility is part of a major development as defined in Art. 8.1.16. *The proposed drive-through restaurant is located within a Town Center activity center and is requesting a Special Land Use Permit.*

R. Whether the proposed use will create a negative shadow impact on any adjoining lot or building as a result of the proposed building height.

The proposed one-story drive-through restaurant will not create a negative shadow impact on any adjoining lot or building.

S. Whether the proposed use would be consistent with the needs of the neighborhood or the community as a whole, be compatible with the neighborhood, and would not be in conflict with the overall objective of the comprehensive plan.

See criteria A and K.

Staff Recommendation

Based on the applicant's willingness to make strides to blend aspects of the TC activity center policies and the need for concise guidance on the vision for the subject property, the Department of Planning and Sustainability recommends **full-cycle deferral**. Additionally, the deferral would permit the applicant to redesign the proposal for compliance with the *Zoning Ordinance*.

However, if the Planning Commission recommends approval, then the Department of Planning and Sustainability recommends the following conditions below:

1. The subject property shall be developed in substantial conformity with the following site plans: "Variance Site Plan", prepared by Bohler, dated 04-29-2021 and with the building elevation attached to the SLUP application.
2. The applicant shall perform a traffic impact analysis and incorporate any recommended site improvements or directly adjacent right-of-way improvements, as approved by the Georgia Department of Transportation or DeKalb County.
3. The applicant shall install or contribute full costs for the installation of a left turn lane on N. Druid Hills Road at Birch Road.
4. No exterior sound systems, outdoor speakers, or sound amplification systems are permitted.
5. The Special Land Use Permit shall be issued to Midtown National Group, LP for a Chik-Fil-A drive-through restaurant only and shall not be transferrable for the purposes of establishing any other drive-through establishment.
6. The approval of this Special Land Use application by the Board of Commissioners has no bearing on the requirements for other regulatory approvals under the authority of the Zoning Board of Appeals, or other entities whose decision should be based on the merits of the application under review by such entity.
7. Truck loading/delivery shall not impede internal circulation on-site.

8. The applicant shall install adequate internal signage. Illustrations and design specifications for internal signage must be provided prior to land development phase approval.
9. If the restaurant partners with meal delivery service providers (e.g. Door Dash, Uber Eats, etc.), a portion of the excess parking spaces for passenger vehicles shall be designated for those meal delivery service providers.

DEPARTMENT OF PLANNING & SUSTAINABILITY

SPECIAL LAND USE PERMIT APPLICATION

Amendments will not be accepted after 5 working days after the filing date.

Date Received: _____ Application No.: _____

APPLICANT NAME: David Kirk, on behalf of Chick-fil-A, Inc.

Daytime Phone #: 404-885-3415 Fax #: N/A

Mailing Address: 600 Peachtree Street, Suite 3000, Atlanta, GA 30308

E-mail: David.Kirk@troutman.com

OWNER NAME: Midtown National Group LP (if
more than one owner, attach contact information for each owner)

Daytime Phone #: N/A Fax #: N/A

Mailing Address: 9171 TOWNE CENTRE DR, STE 335, SAN DIEGO CA 92122

E-mail: N/A

SUBJECT PROPERTY ADDRESS OR LOCATION: 3795 DRUID HILLS RD N
Decatur, DeKalb County, GA, 30033

District(s): Unknown Land Lot(s): 100 Block(s): Unknown Parcel(s): 18 100 04 019

Acreage or Square Feet: 1.04 Commission District(s): 2 and SD6 Existing Zoning: NS (C-1 Proposed)

Proposed Special Land Use (SLUP): Restaurant with Drive-through

I hereby authorize the staff of the Planning and Development Department to inspect the property that is the subject of this application.

Owner: _____ Agent: **Signature of Applicant:** David C. Kirk
(Check One)

Printed Name of Applicant: David C. Kirk

Notary Signature and Seal:
Corinne M Caldwell



David C. Kirk
david.kirk@troutman.com

May 5, 2021

VIA U.S. CERTIFIED MAIL

Address Line
Address Line

Re: DeKalb County Community Meeting #2

Dear Neighbor:

I am writing to inform you of Chick-fil-A, Inc.'s ("Chick-fil-A") proposed Rezoning and Special Land Use Permit Applications (the "Applications") to be submitted to the DeKalb County Department of Planning & Sustainability to allow for the construction and operation of a new Chick-fil-A drive-through restaurant at 3795 North Druid Hills Road NE. This new restaurant will replace the older drive-through restaurant located nearby at 3905 North Druid Hills Road. The requested Rezoning Application seeks to rezone the property from Neighborhood Shopping ("NS") to Local Commercial ("C-1"). The Special Land Use Permit Application seeks approval of the associated drive-through facility. I am attaching for your review a copy of the Site Plan showing the proposed new restaurant and associated drive-through.

Chick-fil-A is holding a second Virtual Community Meeting via Zoom on **Thursday, May 20, 2021** at 5:30 P.M., at which time Chick-fil-A will share details of the proposal with attendees. To join the Virtual Community Meeting, please enter the web address below into your internet browser (with no spaces) and follow the prompts to join the meeting.

Web Address:

<https://troutman.zoom.us/j/92657834227?pwd=K1pGRWpKSk0xM1pBMldyKzdNREIKZz09>

Meeting ID: 926 5783 4227

Password: 425462

You may also join the Virtual Community Meeting by phone via the following number:

Number: 1-929-436-2866

Meeting ID: 926 5783 4227

Passcode: 425462

Should you have any questions about the Applications and proposed Chick-fil-A restaurant, please do not hesitate to give me a call at (404) 885-3415.

Sincerely,

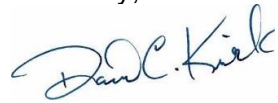

David C. Kirk

CHICK-FIL-A COMMUNITY MEETING SIGN-IN SHEET

Wednesday, April 28, 2021 5:30 p.m.

Virtual Meeting Via Zoom

NAME	ADDRESS
Stacey Russell	EyeTravel737@gmail.com (Mount Olive Drive)
Cedric Hudson	(County)

David C. Kirk
david.kirk@troutman.com

April 29, 2021

VIA FEDERAL EXPRESS AND EMAIL

Mr. Andrew Baker, AICP
Director
DeKalb County Department of Planning & Sustainability
330 West Ponce de Leon Avenue, Suites 100-500
Decatur, Georgia 30030

Re: Rezoning and Special Land Use Permit Application for 3795 North Druid Hills Road

Dear Mr. Baker:

On behalf of Chick-fil-A, Inc. ("Chick-fil-A" or the "Applicant"), I am pleased to provide for review and consideration by DeKalb County this letter of intent and the accompanying application materials in support of the requested Rezoning of the above-referenced property (the "Subject Property") from its current classification Neighborhood Shopping (NS) to the Local Commercial (C-1) classification and Special Land Use Permit ("SLUP") to allow for a drive-through restaurant. If approved, the Rezoning and SLUP will allow for the redevelopment of the Subject Property, which currently contains a vacant retail storefront, into a new, custom-designed 2,800 square-foot Chick-fil-A restaurant with a drive-through facility, outdoor seating, pedestrian improvements, and enhanced landscaping. The proposed development will update the Subject Property into an attractive, modern restaurant in keeping with the demands of the current market, customer expectations and team member needs, and current County requirements.

Included with this letter of intent are the following materials:

- A. An Application to Amend the Official Zoning Map of DeKalb County;
- B. A Special Land Use Permit Application;
- C. A Site Plan;
- D. A Survey and Legal Description of the Subject Property;
- E. A Landscape Plan;

- F. Architectural Elevations and Renderings; and
- G. An impact analysis for the requested SLUP and justification for the proposed Rezoning (included within the body of this letter).

Summary of the Proposed Project

As noted above, the Applicant seeks approvals necessary to redevelop the Subject Property, which now contains a vacant retail store (previously occupied by Pier 1 Imports) and associated street-fronting parking lot. On this property, Chick-fil-A proposes to construct and operate a new, custom-designed restaurant containing approximately 2,800 square feet of space. The restaurant will include a drive-through facility located in the rear of the property with 41 stacking spaces, 29 off-street parking spaces, outdoor seating, an improved streetscape, and enhanced landscaping. The Subject Property is currently zoned Neighborhood Shopping (NS), which does not permit drive-through restaurants. The Applicant requests the Subject Property to be rezoned from NS to Local Commercial (C-1) to allow for a drive-through restaurant. The proposed new restaurant will replace the older Chick-fil-A drive-through restaurant located nearby at 3905 North Druid Hills Road and is designed to better reflect the County's desired goals for design, traffic efficiency, and pedestrian accessibility.

Zoning Map Amendment Review and Approval Criteria

Proposed zoning amendments are evaluated in light of the following standards.

1. *Whether the zoning proposal is in conformity with the policy and intent of the Comprehensive Plan.*

Chick-fil-A's proposed redevelopment of the Subject Property is consistent with the County's Comprehensive Development Plan and Future Land Use Map, which designates the Subject Property as "Town Center." The Subject Property is currently occupied by a commercial retail use and will continue to be used commercially as a result of the proposed redevelopment. The Town Center character area specifically permits C-1 zoning classifications. The proposed building design, including its orientation to the street, enhanced streetscape improvements, and "walk-up" window will encourage pedestrian accessibility consistent with the Town Center goals.

2. *Whether the zoning proposal will permit a use that is suitable in view of the use and development of adjacent and nearby properties.*

The Subject Property is directly adjacent to a Zaxby's drive-through restaurant and is located across the street from a physician's office and the North DeKalb Mall. The proposed restaurant is consistent with the adjacent and nearby commercial uses located along North Druid Hills Road and will replace the vacant retail storefront with a custom-designed restaurant. The Applicant respectfully submits the zoning proposal will permit a use that is suitable in view of the use and development of adjacent and nearby properties and will not only efficiently accommodate vehicular traffic but will also be more welcoming to pedestrians.

3. *Whether the property to be affected by the zoning proposal has a reasonable economic use as currently zoned.*

The Applicant respectfully submits the proposed redevelopment will substantially enhance the economic use of the property by replacing the existing vacant retail store into a new, custom-designed Chick-fil-A restaurant with a drive-through facility, outdoor seating, enhanced landscaping, and streetscape improvements.

4. *Whether the zoning proposal will adversely affect the existing use or usability of adjacent or near-by properties.*

The proposed redevelopment will include a custom-designed, well-landscaped restaurant, and associated drive-through. The proposed redevelopment will have a positive effect on the surrounding neighborhood as it will encourage and accommodate pedestrian access.

5. *Whether there are other existing or changing conditions affecting the use and development of the property which give supporting grounds for either approval or disapproval of the zoning proposal.*

The Subject Property is currently occupied by a vacant retail storefront and associated street-fronting parking lot. The zoning proposal is intended to allow for the redevelopment of the Subject Property as a Chick-fil-A restaurant in a manner that better reflects the County's desired goals for design, traffic efficiency, and pedestrian accessibility. Chick-fil-A seeks to make a significant investment in this location and redevelop the existing site in a manner that it believes will benefit the surrounding community. The proposed drive-through will be located behind the new restaurant building and thus will be shielded from view along the public right-of-way. The proposed site improvements will result in more efficient, inviting, and safe pedestrian and traffic movement within the Subject Property and on nearby roadways and sidewalks.

6. *Whether the zoning proposal will adversely affect historic buildings, sites, districts, or archaeological resources.*

The Applicant respectfully submits the zoning proposal will have no adverse effect on any historic or archaeological resources. The redevelopment will be designed consistent with County's design, transportation accessibility, and landscape goals and the Applicant believes the improvement of the Subject Property will have a positive impact on adjacent and nearby properties.

7. *Whether the zoning proposal will result in a use which will or could cause excessive or burdensome use of existing streets, transportation facilities, utilities or schools.*

The zoning proposal will not cause an excessive or burdensome use of existing streets, transportation facilities, or utilities and will have no impact on school enrollment. The more pedestrian-oriented design of the site should encourage customers who live or work nearby to walk to the restaurant.

Special Land Use Permit Review Criteria

1. *Adequacy of the size of the site for use contemplated and whether or not adequate land area is available for the proposed use including provision of all required yards, open space, off-street parking, and all other applicable requirements of the zoning district in which the use is proposed to be located.*

The Subject Property is just over one acre in size and is sufficient to accommodate the proposed restaurant, outdoor seating, drive-through facility, and necessary parking.

2. *Compatibility of the proposed use with adjacent properties and land uses and with other properties and land uses in the district.*

The Subject Property is directly adjacent to a Zaxby's drive-through restaurant and is located across the street from a physician's office and the North DeKalb Mall. The proposed restaurant is consistent with the commercial uses located in this portion of the County and along North Druid Hills Road and will replace the vacant retail storefront with a custom-designed restaurant. The Applicant respectfully submits the zoning proposal will permit a use that is suitable in view of the use and development of adjacent and nearby properties and will not only efficiently accommodate vehicular traffic but will also be more welcoming to pedestrians

3. *Adequacy of public services, public facilities, and utilities to serve the use contemplated.*

Existing public facilities and services are adequate to serve the proposed restaurant and drive-through facility.

4. *Adequacy of the public street on which the use is proposed to be located and whether or not there is sufficient traffic-carrying capacity for the use proposed so as not to unduly increase traffic and create congestion in the area.*

There is sufficient traffic carrying capacity for the proposed restaurant use on North Druid Hills Road. The zoning proposal will allow for the redevelopment of the Subject Property in a manner that better reflects the County's desired goals for design, traffic efficiency, and pedestrian accessibility. The proposed drive-through will be located

behind the new restaurant building and thus will be shielded from view along the public right-of-way. The proposed site improvements will result in efficient, inviting, and safe pedestrian and traffic movement within the Subject Property and on nearby roadways and sidewalks.

5. *Whether or not existing land uses located along access routes to the site will be adversely affected by the character of the vehicles or the volume of traffic generated by the proposed use.*

The Applicant submits the proposal will have no adverse effect on existing uses located on North Druid Hills Road. The proposed redevelopment should have no impact on the character or volume of vehicular traffic on North Druid Hills Road.

6. *Ingress and egress to the subject property and to all proposed buildings, structures, and uses thereon, with particular references to pedestrian and automotive safety and convenience, traffic flow and control, and access in the event of fire or other emergency.*

Ingress and egress will be provided from North Druid Hills Road and Birch Road. The proposed site improvements will result in efficient, inviting, and safe pedestrian and traffic movement within the Subject Property and on nearby roadways and sidewalks.

7. *Whether or not the proposed use will create adverse impacts upon any adjoining land use by reason of noise, smoke, odor, dust, or vibration generated by the proposed use.*

The proposed use will not create noise, smoke, odor, dust, or vibration.

8. *Whether or not the proposed use will create adverse impacts upon any adjoining land use by reason of the hours of operation of the proposed use.*

The proposed restaurant use will be open Monday through Saturday from approximately 6:30 a.m. to 10:00 p.m. The proposed hours of operation are consistent with other commercial uses located along North Druid Hills Road and will have no negative impact on adjoining land uses.

9. *Whether or not the proposed use will create adverse impacts upon any adjoining land use by reason of the manner of operation of the proposed use.*

The proposed use will be operated in a safe and efficient manner by a local Chick-fil-A operator and will have no adverse impact on adjoining property.

10. *Whether or not the proposed plan is consistent with all of the requirements of the zoning district classification in which the use is proposed to be located.*

The proposed Chick-fil-A restaurant is designed to be consistent with the goals and site development standards of the proposed C-1 zoning district.

11. Whether or not the proposed use is consistent with the policies of the Comprehensive Plan.

Chick-fil-A's proposed redevelopment of the Subject Property is consistent with the County's Comprehensive Development Plan and Future Land Use Map, which designates the Subject Property as "Town Center." The Subject Property is currently occupied by a commercial retail use and will continue to be used commercially as a result of the proposed redevelopment. The Town Center character area specifically permits C-1 zoning classifications. The proposed building design, including its orientation to the street, enhanced streetscape improvements, and "walk-up" window will encourage pedestrian accessibility consistent with the Town Center goals.

12. Whether or not the proposed plan provides for all required buffer zones and transitional buffer zones where required by the regulations of the district in which the use is proposed to be located.

The proposed site design provides for all required setbacks and buffer zones.

13. Whether or not there is adequate provision of refuse and service areas.

As shown on the attached Site Plan, the proposed site design provides for adequate refuse and service areas.

14. Whether the length of time for which the special land use permit is granted should be limited in duration.

Given Chick-fil-A's significant proposed investment in the redevelopment of the Subject Property, Chick-fil-A requests the Special Land Use Permit be granted with no expiration.

15. Whether or not the size, scale and massing of proposed buildings are appropriate in relation to the size of the subject property and in relation to the size, scale and massing of the adjacent and nearby lots and buildings.

The proposed one-story 2,800 square foot restaurant is appropriate in scale and size relative to the Subject Property and relative to other nearby buildings, which are predominantly one-story in height.

16. Whether the proposed plan will adversely affect historic buildings, sites, districts, or archaeological resources.

The zoning proposal will have no adverse effect on any historic or archaeological resources.

17. Whether the proposed use satisfies the requirements contained within the Supplemental Regulations for such special land use permit.

The proposed restaurant and associated drive-through facility meets the standards provided in Section 4.2.23 of the County's Ordinance concerning drive-through facilities.

18. Whether or not the proposed building as a result of its proposed height will create a negative shadow impact on any adjoining lot or building.

The proposed one-story building will have no negative shadow impact on adjacent properties.

19. Whether the proposed use would result in a disproportional proliferation of that or similar uses in the subject character area.

Approval of the proposed redevelopment of the Subject Property will not result in a disproportional proliferation of restaurant or drive-through uses. The proposed restaurant will replace the existing Chick-fil-A drive-through restaurant located nearby at 3905 North Druid Hills Road.

20. Whether the proposed use would be consistent with the needs of the neighborhood or of the community as a whole, be compatible with the neighborhood, and would not be in conflict with the overall objectives of the comprehensive plan.

Consistent with the County's design goals, the objectives of the comprehensive plan, and the neighborhood and community character, the proposed new restaurant is designed to better reflect the County's desired goals for design, traffic efficiency, and pedestrian accessibility.

Summary and Conclusion

I believe this letter of intent, together with the accompanying application and supporting documents, provide all the information required by the County to review and evaluate this request. If there are other materials or information you believe would be helpful to your review of this request, please do not hesitate to contact me. I look forward to our continued cooperative efforts on this important matter.

Yours very truly,



David C. Kirk
Attorney for Chick-fil-A

EXHIBIT A

Chief Executive Officer
Michael Thurmond

DEPARTMENT OF PLANNING & SUSTAINABILITY

Director
Andrew A. Baker, AICP

PRE-APPLICATION FORM
REZONE, SPECIAL LAND USE PERMIT, MODIFICATION, AND LAND USE
(Required prior to filing application: signed copy of this form must be submitted at filing)

Applicant Name: David Kirk, on behalf of Chick-fil-A Phone: 404-885-3415 Email: David.Kirk@troutman.com

Property Address: 3795 North Druid Hills Road

Tax Parcel ID: 18 100 04 019 Comm. District(s): 2 Acreage: 1.04

Existing Use: Commercial (Retail) Proposed Use Commercial (Restaurant)

Supplemental Regs: _____ Overlay District: _____ DRI: _____

Rezoning: Yes No _____

Existing Zoning: NS Proposed Zoning: C-1 Square Footage/Number of Units: 2,800 sf

Rezoning Request: Chick-fil-A requests to rezone the property from NS to C-1 to allow for development of a Chick-fil-A restaurant and drive-through. Chick-fil-A intends to also submit a Special Land Use Permit application to allow for the proposed drive-through facility.

Land Use Plan Amendment: Yes _____ No

Existing Land Use: TC Proposed Land Use: _____ Consistent Inconsistent _____

Special Land Use Permit: Yes No _____ Article Number(s) 27- Section 4.2.23

Special Land Use Request(s) Drive-through Facility

Major Modification:

Existing Case Number(s): _____

Condition(s) to be modified:

DEPARTMENT OF PLANNING & SUSTAINABILITY

WHAT TO KNOW BEFORE YOU FILE YOUR APPLICATION

Pre-submittal Community Meeting: _____ Review Calendar Dates: PC: BOC:
 Letter of Intent: Impact Analysis: Owner Authorization(s): Campaign Disclosure:
 Zoning Conditions: _____ Community Council Meeting: _____ Public Notice, Signs: _____
 Tree Survey, Conservation: _____ Land Disturbance Permit (LDP): _____ Sketch Plat: _____
 Bldg. Permits: _____ Fire Inspection: _____ Business License: _____ State License: _____
 Lighting Plan: _____ Tent Permit: _____ Submittal Format: NO STAPLES, NO BINDERS PLEASE

Review of Site Plan

Density: NA Density Bonuses: NA Mix of Uses: NA Open Space: NA Enhanced
 Open Space: NA Setbacks: front sides side corner rear Lot Size:
 _____ Frontage: _____ Street Widths: _____ Landscape Strips: Buffers:
 Parking Lot Landscaping: _____ Parking - Auto: Parking - Bicycle: NA Screening:
NA Streetscapes: _____ Sidewalks: _____ Fencing/Walls: Bldg. Height: Bldg.
 Orientation: Bldg. Separation: NA Bldg. Materials: Roofs: Fenestration: NA
 Façade Design: Garages: NA Pedestrian Plan: NA Perimeter Landscape Strip:
 Possible Variances: retaining wall is 5' high @ highest point - no variance needed

Comments:

Applicant requested but did not receive Neighborhood Registry of complete list of contacts - will set up 200 community meetings before amendment date of May 6.

Planner: Melora Ferrman

Date 4/28/21

Filing Fees

REZONING:	RE, RLG, R-100, R-85, R-75, R-60, MHP, RSM, MR-1	\$500.00
	RNC, MR-2, HR-1, HR-2, HR-3, MU-1, MU-2, MU-3, MU-4, MU-5	\$750.00
	OI, OD, OIT, NS, C1, C2, M, M2	\$750.00
LAND USE MAP AMENDMENT		\$500.00
SPECIAL LAND USE PERMIT		\$400.00

Chief Executive Officer
Michael Thurmond

DEPARTMENT OF PLANNING & SUSTAINABILITY

Director
Andrew A. Baker, AICP

REZONE APPLICATION AUTHORIZATION

Completion of this form is required if the individual making the request is not the owner of the property.

DATE: 4/26/2021

CHECK TYPE OF APPLICATION:

- LAND USE PLAN
- REZONE
- MINOR MODIFICATION

TO WHOM IT MAY CONCERN:

(1) ~~(WE)~~, Danon Young, on behalf of Midtown National Group LP
(Name of owner(s))

being (owner)/(owners) of the property described below or attached hereby delegate authority to
David C. Kirk, Troutman Pepper Hamilton Sanders LLP
(Name of Applicant or Agent Representing Owner)

to file an application on (my) / (our) behalf.

~~Notary Public~~

~~Notary Public~~

~~Notary Public~~

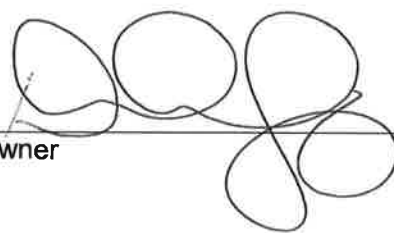
Owner

Owner

Owner

see attached Notary Acknowledgment

CALIFORNIA ALL-PURPOSE ACKNOWLEDGMENT

CIVIL CODE § 1189

A notary public or other officer completing this certificate verifies only the identity of the individual who signed the document to which this certificate is attached, and not the truthfulness, accuracy, or validity of that document.

State of California)
County of San Diego)
On April 26, 2021 before me, Giovanna Delia, Notary Public,
Date Here Insert Name and Title of the Officer
personally appeared Damon Young
Name(s) of Signer(s)

who proved to me on the basis of satisfactory evidence to be the person(s) whose name(s) is/are subscribed to the within instrument and acknowledged to me that he/she/they executed the same in his/her/their authorized capacity(ies), and that by his/her/their signature(s) on the instrument the person(s), or the entity upon behalf of which the person(s) acted, executed the instrument.

I certify under PENALTY OF PERJURY under the laws of the State of California that the foregoing paragraph is true and correct.

WITNESS my hand and official seal.



Signature Giovanna Delia
Signature of Notary Public

Place Notary Seal Above

OPTIONAL

Though this section is optional, completing this information can deter alteration of the document or fraudulent reattachment of this form to an unintended document.

Description of Attached Document

Title or Type of Document: _____
Document Date: _____ Number of Pages: _____
Signer(s) Other Than Named Above: _____

Capacity(ies) Claimed by Signer(s)

Signer's Name: _____
 Corporate Officer — Title(s): _____
 Partner — Limited General
 Individual Attorney in Fact
 Trustee Guardian or Conservator
 Other: _____
Signer Is Representing: _____

Signer's Name: _____
 Corporate Officer — Title(s): _____
 Partner — Limited General
 Individual Attorney in Fact
 Trustee Guardian or Conservator
 Other: _____
Signer Is Representing: _____

EXHIBIT B

DEPARTMENT OF PLANNING & SUSTAINABILITY

SPECIAL LAND USE PERMIT APPLICATION AUTHORIZATION

The property owner should complete this form or a similar, signed and notarized form if the individual who will file the application with the County is not the property owner.

Date: 4/26/2021

TO WHOM IT MAY CONCERN:

(I) ~~(WE)~~, Daron Young, on behalf of Midtown National Group LP
Name of Owner(s)

being (owner) (~~owners~~) of the subject property described below or attached hereby delegate authority to
David C. Kirk, Troutman Pepper Hamilton Sanders LLP
Name of Applicant or Agent

to file an application on (my) (our) behalf.

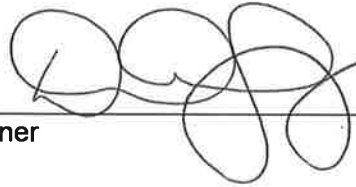

Notary Public

Owner

Notary Public

Owner

Notary Public

Owner

Notary Public

Owner

see attached Notary Acknowledgment

CALIFORNIA ALL-PURPOSE ACKNOWLEDGMENT

CIVIL CODE § 1189

A notary public or other officer completing this certificate verifies only the identity of the individual who signed the document to which this certificate is attached, and not the truthfulness, accuracy, or validity of that document.

State of California)
County of San Diego)
On April 26, 2021 before me, Giovanna Delia, Notary Public,
Date Here Insert Name and Title of the Officer
personally appeared Daron Young
Name(s) of Signer(s)

who proved to me on the basis of satisfactory evidence to be the person(s) whose name(s) is/are subscribed to the within instrument and acknowledged to me that he/she/they executed the same in his/her/their authorized capacity(ies), and that by his/her/their signature(s) on the instrument the person(s), or the entity upon behalf of which the person(s) acted, executed the instrument.

I certify under PENALTY OF PERJURY under the laws of the State of California that the foregoing paragraph is true and correct.

WITNESS my hand and official seal.



Signature Giovanna Delia
Signature of Notary Public

Place Notary Seal Above

OPTIONAL

Though this section is optional, completing this information can deter alteration of the document or fraudulent reattachment of this form to an unintended document.

Description of Attached Document

Title or Type of Document: _____

Document Date: _____ Number of Pages: _____

Signer(s) Other Than Named Above: _____

Capacity(ies) Claimed by Signer(s)

Signer's Name: _____

Corporate Officer — Title(s): _____

Partner — Limited General

Individual Attorney in Fact

Trustee Guardian or Conservator

Other: _____

Signer Is Representing: _____

Signer's Name: _____

Corporate Officer — Title(s): _____

Partner — Limited General

Individual Attorney in Fact

Trustee Guardian or Conservator

Other: _____

Signer Is Representing: _____

EXHIBIT C

SITE DATA	
ZONING:	C-1 (LOCAL COMMERCIAL)
FUTURE LAND USE DESIGNATION:	TC (TOWN CENTER)
PARCEL IDENTIFICATION NUMBER:	1810004019
TOTAL SITE AREA:	1.047 AC.
DISTURBED AREA:	1.1 AC.
IMPERVIOUS SURFACE AREA MAXIMUM (%):	0.942 AC. (90.0%)
IMPERVIOUS SURFACE AREA PROPOSED (%):	0.726 AC. (69.3%)
OPEN SPACE AREA REQUIRED (%):	0.105 AC. (10.0%)
OPEN SPACE AREA PROPOSED (%):	0.321 AC. (30.6%)
FLOOR AREA RATIO MAXIMUM:	20.00%
FLOOR AREA RATIO PROPOSED:	6.14%
BUILDING HEIGHT PROPOSED:	21' - 4"
BUILDING SETBACK - FRONT (BIRCH ROAD):	20 FT MIN. / 60 FT MAX.
SIDE (N. DRUID HILLS RD.):	30 FT
SIDE (INTERIOR):	30 FT
REAR:	20 FT
LANDSCAPE BUFFER - FRONT (BIRCH ROAD):	10 FT
SIDE (N. DRUID HILLS RD.):	5 FT
SIDE (INTERIOR):	5 FT
REAR:	5 FT
BUILDING FLOOR AREA:	2,800 S.F.
PARKING RATIO REQUIRED - MAX: 1 SPACE PER /150 S.F. = 19 SPACES	MIN: 1 SPACE / 250 S.F. = 12 SPACES
PARKING PROVIDED:	29 SPACES
ACCESSIBLE PARKING REQUIRED:	2 SPACES
ACCESSIBLE PARKING PROVIDED:	2 SPACES

- NOTES:
- THIS PLAN IS CONCEPTUAL IN NATURE AND SUBJECT TO CHANGE
 - THIS PROPERTY IS NOT LOCATED IN A SPECIAL FLOOD HAZARD AREA BASED ON THE FLOOD INSURANCE RATE MAP FOR THIS AREA. THE MAP NUMBER FOR THIS AREA IS 13089C0067K, AND THE DATE OF SAID MAP IS AUGUST 15, 2019.
 - NO STREAMS EXIST ON THE PROPERTY.

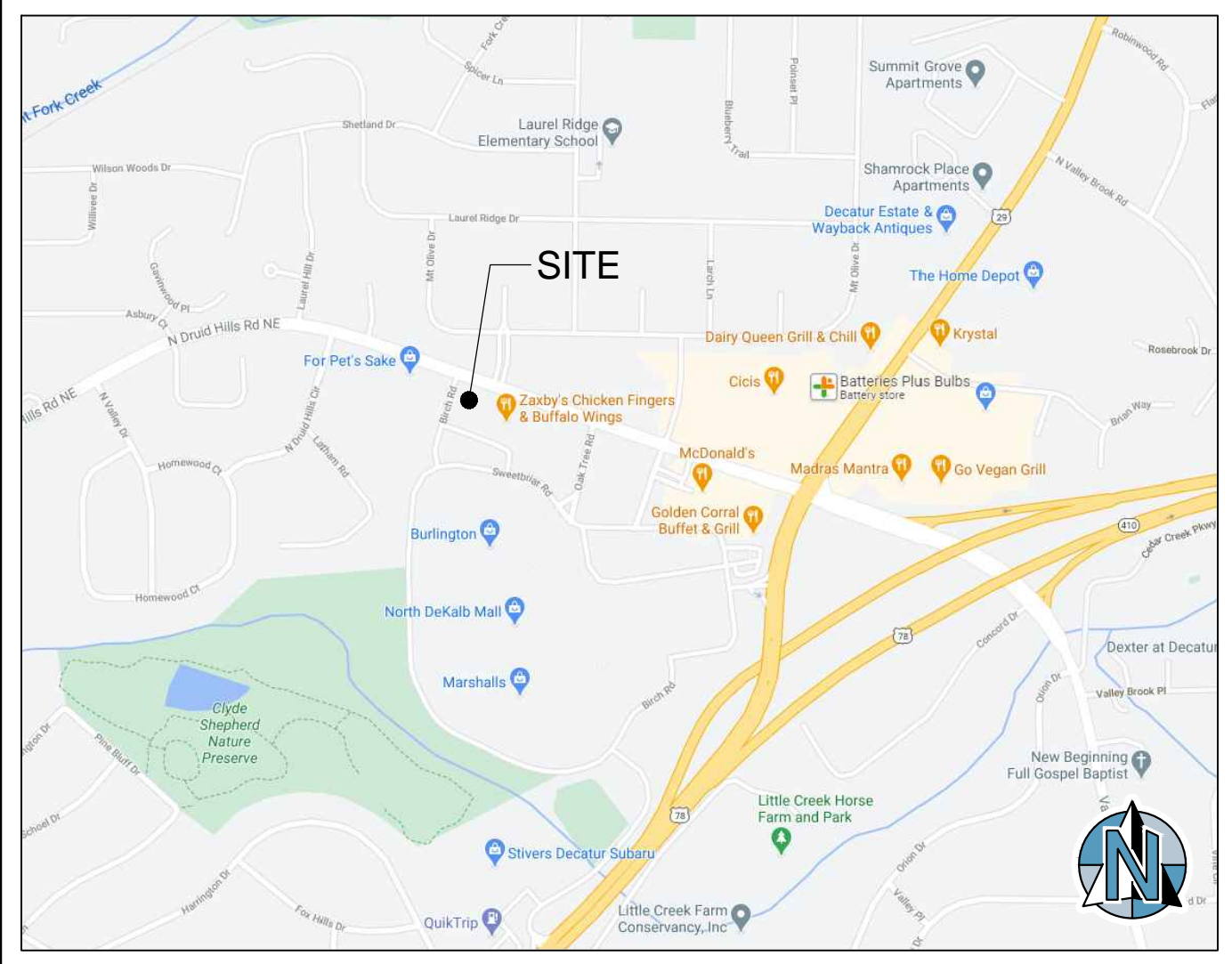

VICINITY MAP NOT TO SCALE

N/F PROJ
PATTEN & P.
 DEED BOOK 24380 / PAGE 212
 1/2" RBR FND
 EXISTING H&I

N/F PROPERTY OF
LCI-SVAP NDM JV, LP
 DEED BOOK 24380 / PAGE 239
 ZONED C-1

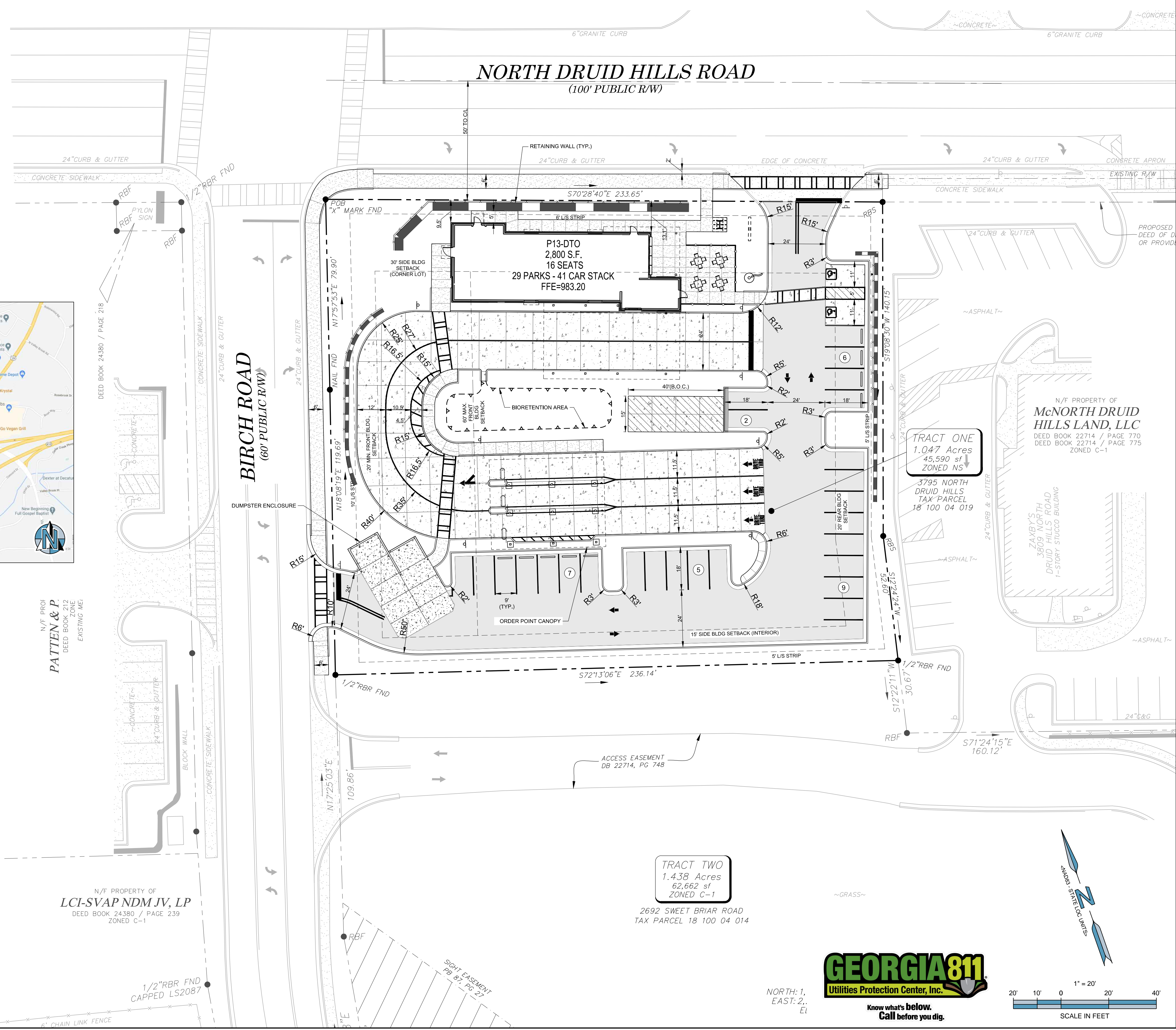

TRACT ONE
 1.047 Acres
 45,590 sf
 ZONED NS
 3795 NORTH DRUID HILLS RD
 TAX PARCEL 18 100 04 019

TRACT TWO
 1.438 Acres
 62,662 sf
 ZONED C-1
 2692 SWEET BRIAR ROAD
 TAX PARCEL 18 100 04 014

5200 BUFFINGTON ROAD
 ATLANTA, GA 30349-2998

DEVELOPER:
CHICK-FIL-A, INC.
 5200 BUFFINGTON ROAD
 ATLANTA GA 30349-2998
 (404) 808-1145

CONTACT: MR. JASON POCIASK

ENGINEER:
FORESITE group
 Foresite Group, LLC. w | www.fg-inc.net
 3740 Davinci Ct. o | 770.368.1399
 Suite 100 f | 770.368.1944
 Peachtree Corners, GA 30092

PROJECT:
 3795 NORTH DRUID HILLS RD.
 DECATUR, GA 30033
 PARCEL #:1810004019

FSR #04846

SEAL:

REVISIONS	DATE

PROJECT MANAGER: JMJ
 DRAWING BY: JRH
 JURISDICTION: DEKALB COUNTY, GA
 DATE: 2021-04-12
 SCALE: 1" = 20'
 TITLE:

PRELIMINARY SITE PLAN

SHEET NUMBER:
C-2.0

COMMENTS: NOT RELEASED FOR CONSTRUCTION

JOB/FILE NUMBER: 397.010

GEORGIA811
 Utilities Protection Center, Inc.
 Know what's below.
 Call before you dig.

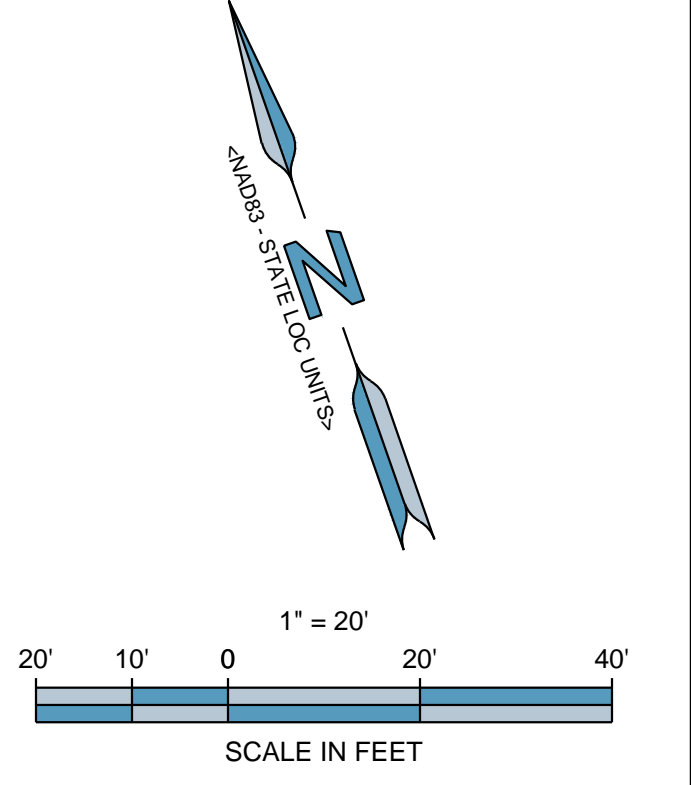

P:\2021\04\1810004019\1810004019.DWG: 04/13/2021 10:53:09 AM BUCKLE UP, INC. 1810004019.DWG: 04/13/2021 10:53:09 AM BUCKLE UP, INC.

EXHIBIT D

TRACT ONE PROPERTY DESCRIPTION

All that tract or parcel of land lying or being in Land Lot 100, 18th District, Dekalb County, Georgia, and being more particularly described as follows:

Beginning at an X mark found at the intersection of the Easterly right-of-way of Birch Road (60 foot right-of-way) with the Southerly right-of-way of North Druid Hills Road (100 foot right-of-way); thence along said right-of-way of North Druid Hills Road South 70 degrees 28 minutes 40 seconds East, a distance of 233.65 feet to a 5/8 inch rebar set; thence leaving said right-of-way South 19 degrees 08 minutes 30 seconds West, a distance of 140.15 feet to a 5/8 inch rebar set; thence South 12 degrees 24 minutes 24 seconds West, a distance of 52.60 feet to a 1/2 inch rebar found; thence North 72 degrees 13 minutes 06 seconds West, a distance of 236.14 feet to a 1/2 inch rebar found on the Easterly right-of-way of Birch Road; thence along said right-of-way North 18 degrees 08 minutes 19 seconds East, a distance of 119.69 feet to a nail found; thence North 17 degrees 57 minutes 53 seconds East, a distance of 79.90 feet to an X mark found, said point being the True Point of Beginning.

Said tract of land contains 1.047 Acres.

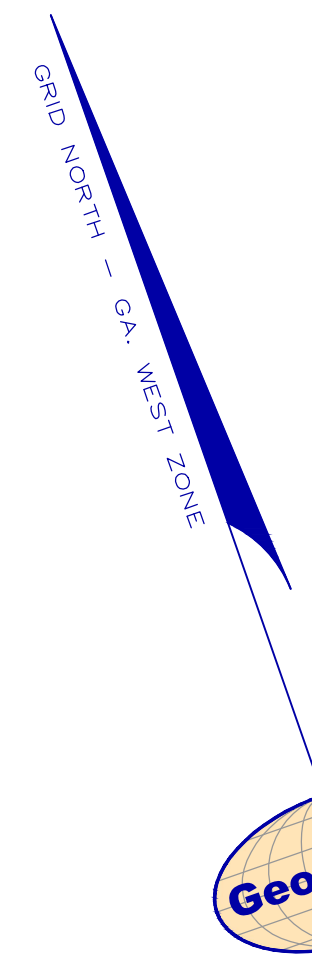

(CLERK OF COURT RECORDING INFORMATION)

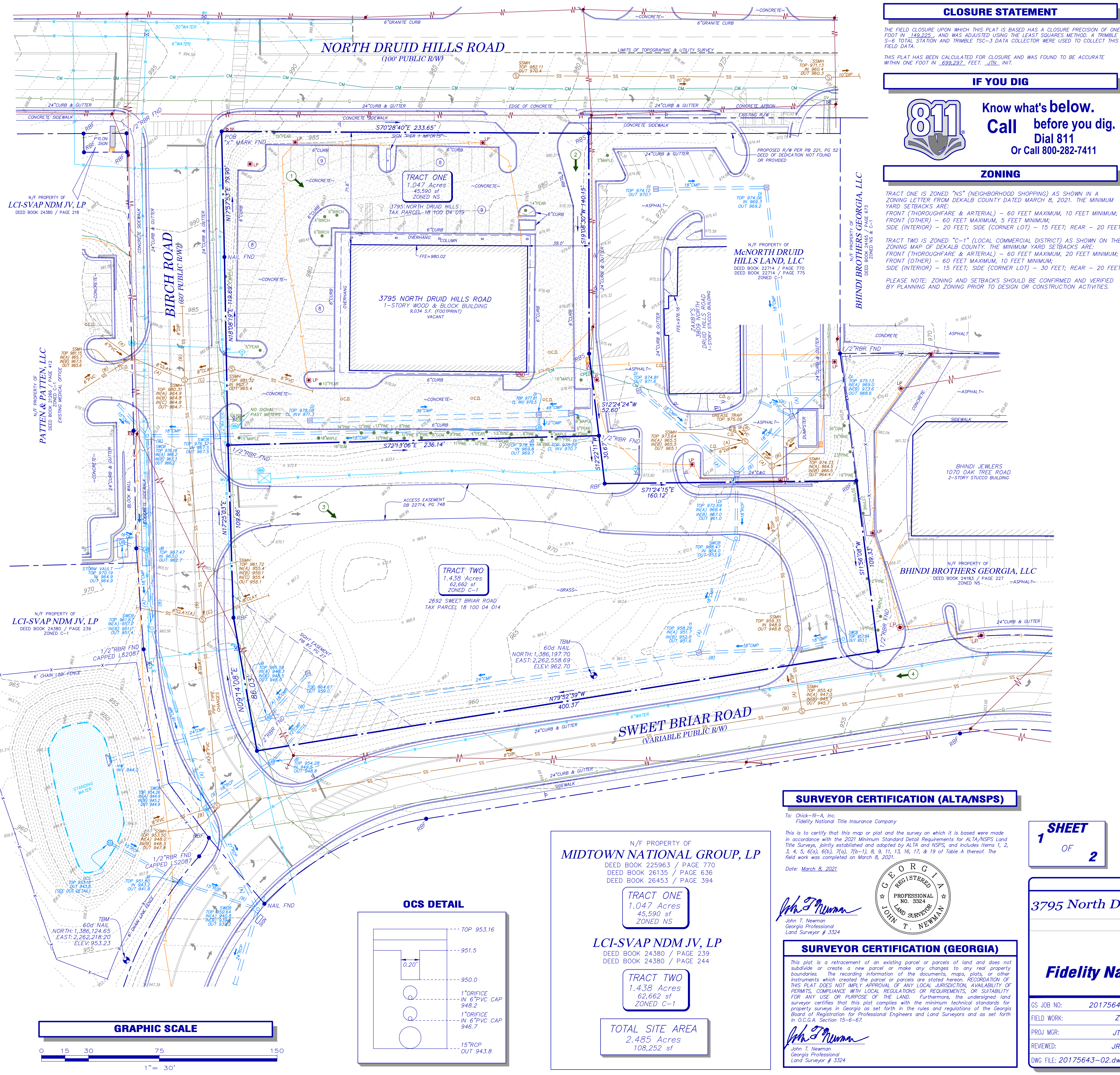

CLOSURE STATEMENT

THE FIELD CLOSURE UPON WHICH THIS PLAN IS BASED HAS A CLOSURE PRECISION OF ONE FOOT IN 149,225, AND WAS ADJUSTED USING THE LEAST SQUARES METHOD. A TRIMBLE S-6 TOTAL STATION AND TRIMBLE TSC-3 DATA COLLECTOR WERE USED TO COLLECT THIS FIELD DATA.

THIS PLAN HAS BEEN CALCULATED FOR CLOSURE AND WAS FOUND TO BE ACCURATE WITHIN ONE FOOT IN 699,297 FEET, \pm IN. INT.

IF YOU DIG



Know what's below.
Call before you dig.
Dial 811
Or Call 800-282-7411

ZONING

TRACT ONE IS ZONED "NS" (NEIGHBORHOOD SHOPPING) AS SHOWN IN A ZONING LETTER FROM DEKALB COUNTY DATED MARCH 8, 2021. THE MINIMUM YARD SETBACKS ARE:
FRONT (THOROUGHFARE & ARTERIAL) - 60 FEET MAXIMUM, 10 FEET MINIMUM;
FRONT (OTHER) - 60 FEET MAXIMUM, 5 FEET MINIMUM;
SIDE (INTERIOR) - 20 FEET; SIDE (CORNER LOT) - 15 FEET; REAR - 20 FEET.

TRACT TWO IS ZONED "C-1" (LOCAL COMMERCIAL DISTRICT) AS SHOWN ON THE ZONING MAP OF DEKALB COUNTY; THE MINIMUM YARD SETBACKS ARE:
FRONT (THOROUGHFARE & ARTERIAL) - 60 FEET MAXIMUM, 20 FEET MINIMUM;
FRONT (OTHER) - 60 FEET MAXIMUM, 10 FEET MINIMUM;
SIDE (INTERIOR) - 15 FEET; SIDE (CORNER LOT) - 30 FEET; REAR - 20 FEET.

PLEASE NOTE: ZONING AND SETBACKS SHOULD BE CONFIRMED AND VERIFIED BY PLANNING AND ZONING PRIORITY TO DESIGN OR CONSTRUCTION ACTIVITIES.

VICINITY MAP

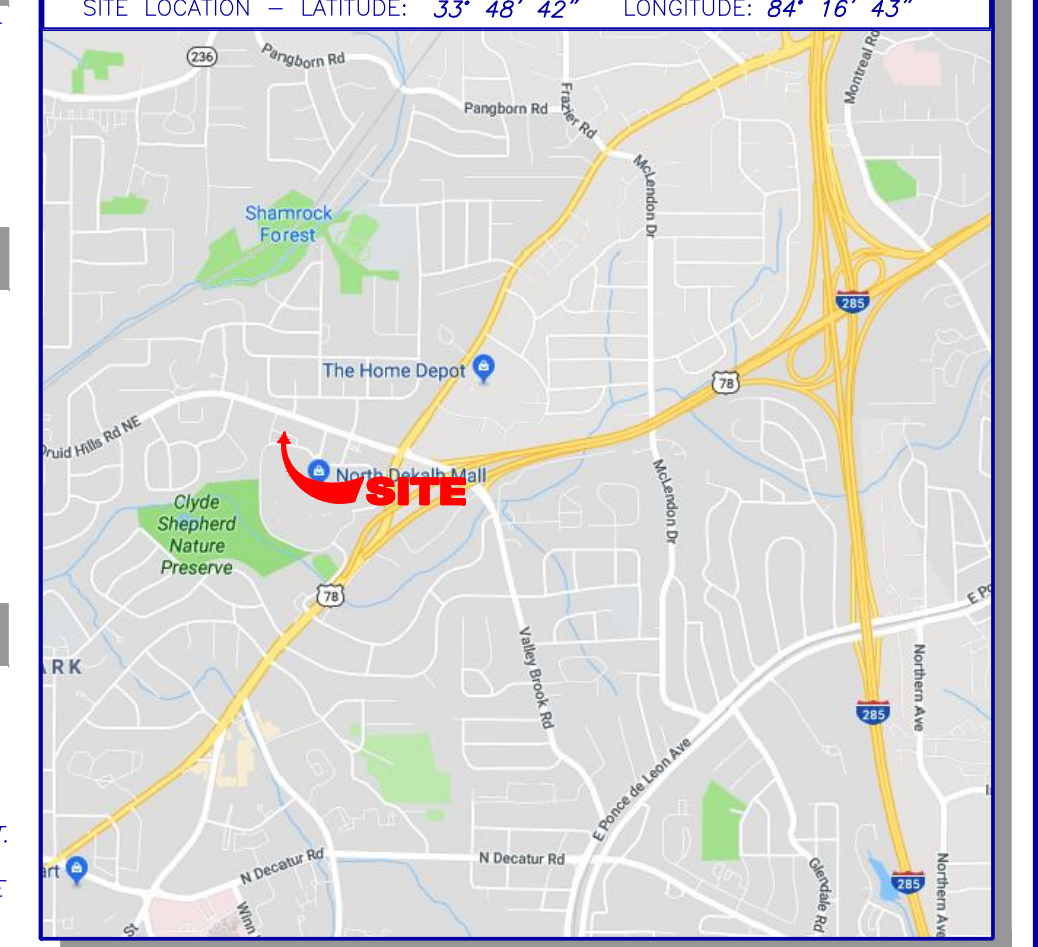

GENERAL NOTES

THIS SURVEY HAS BEEN PREPARED FOR THE EXCLUSIVE USE OF THE PERSON OR ENTITIES NAMED HEREON. NO EXPRESS OR IMPLIED WARRANTIES WITH RESPECT TO THE INFORMATION SHOWN HEREON IS TO BE EXTENDED TO ANY PERSONS OR ENTITIES OTHER THAN THOSE SHOWN HEREON.

REVISIONS LISTED ON THIS SURVEY APPLY ONLY TO THE SPECIFIC CHANGES REFERENCED, AND DO NOT CONSTITUTE AN UPDATE OF OTHER DATA ON THIS SURVEY. THE SURVEY DATE HEREON IS THE APPLICABLE DATE AS RELATED TO PROVISIONS OF STATUTES OF LIMITATION UNLESS SPECIFICALLY NOTED OTHERWISE.

THIS PROPERTY IS NOT LOCATED IN A SPECIAL FLOOD HAZARD AREA BASED ON THE FLOOD INSURANCE RATE MAP FOR THIS AREA. THE MAP NUMBER FOR THIS AREA IS 13089C0067K, AND THE DATE OF SAID MAP IS AUGUST 15, 2019. THIS DETERMINATION WAS MADE BY GRAPHICALLY DETERMINING THE POSITION OF THIS SITE ON SAID FIRM MAPS UNLESS OTHERWISE NOTED.

PLEASE NOTE: TREES 4-INCH DBH (DIAMETER AT BREAST HEIGHT) AND LARGER WERE LOCATED FOR THIS SURVEY.

RIGHT-OF-WAY LINES SHOWN ON THIS SURVEY THAT ARE NOT ACTUAL BOUNDARIES OF THE SUBJECT TRACT(S) ARE DEPICTED GRAPHICALLY AND ARE SHOWN APPROXIMATELY FOR INFORMATIONAL PURPOSES ONLY. SAID RIGHT-OF-WAY LINES SHOULD NOT BE UTILIZED FOR DESIGN PURPOSES.

THE DATUM FOR THIS SITE WAS ESTABLISHED UTILIZING GLOBAL POSITIONING SYSTEMS, AND BASED ON POSITIONAL VALUES FOR THE VIRTUAL REFERENCE STATION NETWORK DEVELOPED BY eGPS SOLUTIONS. THE HORIZONTAL REFERENCE FRAME IS NORTH AMERICAN DATUM OF 1983(2011)-STATE PLANE COORDINATE SYSTEM OF GEORGIA-WEST ZONE. THE VERTICAL REFERENCE FRAME IS NORTH AMERICAN VERTICAL DATUM OF 1988. ANY DIRECTIONS OR DIMENSIONS SHOWN ARE A RECTANGULAR, GROUND LEVEL PROJECTION OF THE STATE PLANE COORDINATE SYSTEM.

NO EVIDENCE OF THE SITE BEING USED AS A SOLID WASTE DUMP, SUMP OR SANITARY LANDFILL WAS OBSERVED DURING THE TIME FIELD WORK WAS PERFORMED ON THE SUBJECT PARCEL.

ALL MATTERS SHOWN ON RECORDED PLATS PROVIDED TO THE SURVEYOR ARE SHOWN ON THE SURVEY.

AT THE DATE OF THIS SURVEY, THE SUBJECT PROPERTY HAD ACCESS TO AND FROM A DULY DEDICATED PUBLIC RIGHT-OF-WAY, NORTH DRUID HILLS ROAD AND BIRCH ROAD. THE SURVEYOR MAKES NO CERTIFICATION AS TO WHETHER OR NOT THESE ACCESS POINTS HAVE BEEN APPROVED OR PERMITTED BY JURISDICTIONAL AUTHORITIES.

THE SUBJECT PROPERTY IS CONTIGUOUS WITH ADJACENT RIGHT-OF-WAYS WITHOUT GAPS, GORES, OR OVERLAPS.

NO VISIBLE ABOVE-GROUND ENCROACHMENTS WERE OBSERVED AT THE DATE OF SURVEY.

ALTA CERTIFICATION TABLE "A" NOTES:
Item 16 - No evidence of current earth moving work, building construction or building additions was observed at the date of survey.
Item 17 - No evidence was observed indicating changes in street right of way lines either completed or proposed.

SURVEY REFERENCES
1> ALTA/NSPS LAND TITLE SURVEY OF NORTH DEKALB MALL, PREPARED BY GEOSURVEY, LTD., DATED DECEMBER 15, 2021. (JOB NO. 20175643)

SITE PHOTOGRAPHS



LEGEND

- | | |
|---------------------------------|----------------------------------|
| STANDARD ABBREVIATIONS | STANDARD SYMBOLS |
| AC AIR CONDITIONER | ⊕ OVERHEAD TRAFFIC SIGNAL LIGHT |
| BH BORE HOLE | ⊖ POWER POLE |
| BSL BUILDING SETBACK LINE | — GUY WIRE |
| CI CURB INLET | — POWER LINE |
| CMP CORRUGATED METAL PIPE | ⊕ LIGHT POLE |
| CMF CONCRETE MONUMENT FND | ⊕ ELECTRIC TRANSFORMER |
| CO SANITARY CLEANOUT | ⊕ WATER VAULT |
| CPED COMMUNICATION PEDESTAL | ⊕ GAS VALVE |
| CPED CRIMPED TOP PIPE | ⊕ GAS METER |
| DI DROP INLET | ⊕ WATER VALVE |
| DIP DUCTILE IRON PIPE | ⊕ WATER METER |
| DWBC DOUBLE WING CATCH BASIN | ⊕ FIRE HYDRANT |
| FNC FENCE | — UNDERGROUND ELECTRIC LINE |
| GM GAS METER | — UNDERGROUND GAS LINE |
| FND FOUND | — UNDERGROUND COMMUNICATION LINE |
| GM GAS METER | — UNDERGROUND WATER LINE |
| INV INVERT | ⊕ PHOTO POSITION INDICATOR |
| JB JUNCTION BOX | ⊕ REGULAR PARKING SPACE COUNT |
| MB MANHOLE | ⊕ HANDICAP PARKING SPACE |
| OCS OUTLET CONTROL STRUCTURE | ⊕ TREE POSITION INDICATOR |
| OPN OPEN TOP PIPE | |
| PM POWER METER | |
| PMB POINT OF BEGINNING | |
| POC POINT OF COMMENCEMENT | |
| RPC REINFORCED CONCRETE PIPE | |
| RFB 5/8" RFB FND CAPPED LSF 621 | |
| RBR 5/8" RBR SET CAPPED LSF 621 | |
| SS SANITARY SEWER | |
| SWB SINGLE WING CATCH BASIN | |
| TRANS ELECTRIC TRANSFORMER | |

GRAPHIC SCALE

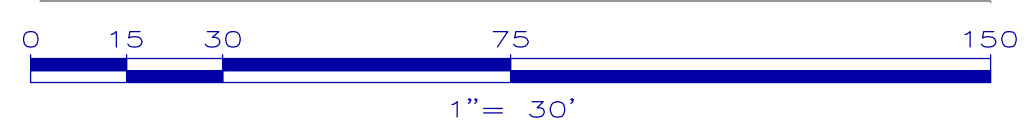

OCS DETAIL

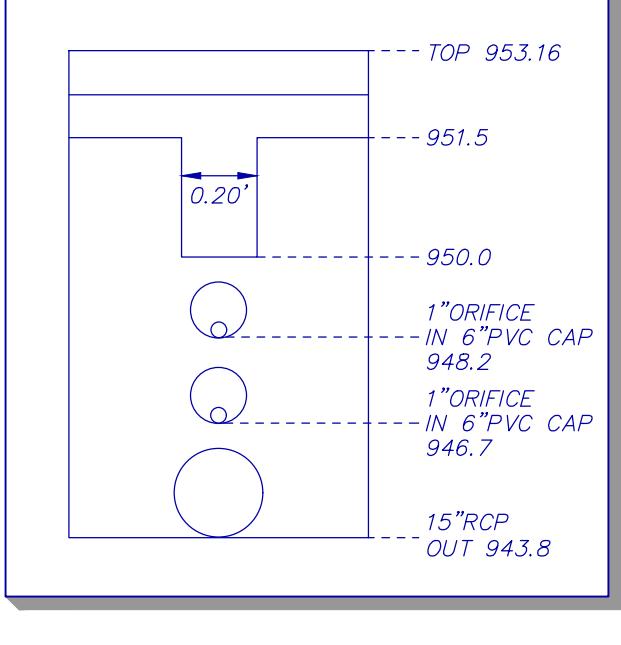

N/F PROPERTY OF
MIDTOWN NATIONAL GROUP, LP
DEED BOOK 225963 / PAGE 770
DEED BOOK 26135 / PAGE 636
DEED BOOK 26453 / PAGE 394

TRACT ONE
1.047 Acres
45,590 sf
ZONED NS

LCI-SVAP NDM JV, LP
DEED BOOK 24380 / PAGE 239
DEED BOOK 24380 / PAGE 244

TRACT TWO
1.438 Acres
62,662 sf
ZONED C-1

TOTAL SITE AREA
2.485 Acres
108,252 sf

SURVEYOR CERTIFICATION (ALTA/NSPS)

To: Chick-fil-A, Inc.
Fidelity National Title Insurance Company

This is to certify that this map or plat and the survey on which it is based were made in accordance with the 2021 Minimum Standard Detail Requirements for ALTA/NSPS Land Title Surveys, jointly established and adopted by ALTA and NSPS, and includes Items 1, 2, 3, 4, 5, 6(a), 6(b), 7(a), 7(b-1), 8, 9, 11, 13, 16, 17, & 19 of Table A thereof. The field work was completed on March 8, 2021.

Date: March 8, 2021

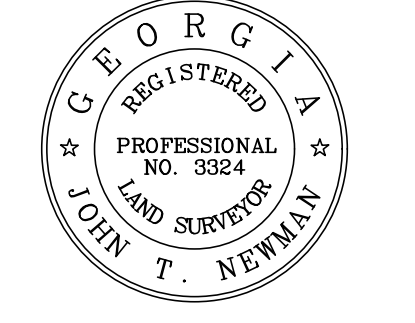

SURVEYOR CERTIFICATION (GEORGIA)

This plat is a retracement of an existing parcel or parcels of land and does not subdivide or create a new parcel or make any changes to any real property boundaries. The recording information of the documents, maps, plats, or other instruments which created the parcel or parcels are stated herein. RECORDATION OF THIS PLAT DOES NOT IMPLY APPROVAL OF ANY LOCAL JURISDICTION, AVAILABILITY OF PERMITS, COMPLIANCE WITH LOCAL REGULATIONS OR REQUIREMENTS, OR SUITABILITY FOR ANY USE OR PURPOSE OF THE LAND. Furthermore, the undersigned land surveyor certifies that this plat complies with the minimum technical standards for property surveys in Georgia as set forth in the rules and regulations of the Georgia Board of Registration for Professional Engineers and Land Surveyors and as set forth in O.C.G.A. Section 15-6-67.

John T. Newman
Georgia Professional Land Surveyor # 3324

1 SHEET
OF
2

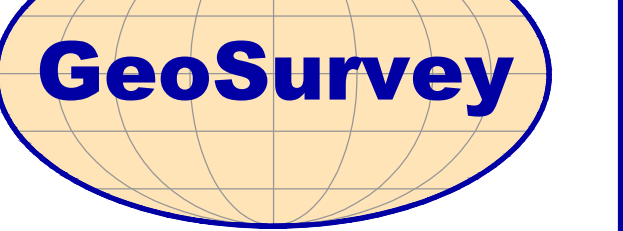

Land Surveying • 3D Laser Scanning
1660 Barnes Mill Road
Marietta, Georgia 30062
Phone: (770) 795-9900
Fax: (770) 795-8880
www.geosurvey.com
EMAIL: info@geosurvey.com
Certificate of Authorization #LSF-000621

ALTA/NSPS LAND TITLE SURVEY		3795 North Druid Hills Rd & 2692 Sweet Briar Rd	
FOR			
Chick-fil-A, Inc.			
Fidelity National Title Insurance Company			
GS JOB NO:	20175643	DRAWING SCALE:	1" = 30'
FIELD WORK:	ZM	CITY:	UNINCORPORATED
PROJ MGR:	JTN	COUNTY:	DEKALB
REVIEWED:	JRC	STATE:	GA
DWG FILE:	20175643-02.dwg	DISTRICT:	18TH
SURVEY DATE:		03-08-2021	
REVISIONS (SEE GENERAL NOTES)		No. Date Description	
1. 3-12-21		Add zoning letter	

TITLE EXCEPTIONS

THE FOLLOWING EXCEPTIONS ARE LISTED IN SCHEDULE B, SECTION 2, OF A COMMITMENT FOR TITLE INSURANCE, AS PREPARED BY FIDELITY NATIONAL TITLE INSURANCE COMPANY, INSURANCE NO. 201819GA, EFFECTIVE DATE OCTOBER 26, 2020.
13. Easements from T.C. Holms to Georgia Power Company as follows:
a. Dated January 4, 1953, filed August 4, 1953, Recorded in Deed Book 985, Page 486, aforesaid records.
MAY AFFECT SITE - BLANKET EASEMENT WITH VAGUE DESCRIPTION - NOT PLOTTABLE
b. Dated December 3, 1954, filed January 4, 1955, Recorded in Deed Book 1080, Page 398, aforesaid records.
AFFECTS SITE - BLANKET EASEMENT - NOT PLOTTABLE
14. Right of Way Deed from Beech-Nut, Inc. to DeKalb County, dated July 28, 1969, filed August 6, 1969, Recorded in Deed Book 2445, Page 324, aforesaid records.
AFFECTS SITE - BLANKET EASEMENT - NOT PLOTTABLE
15. Right of Way Easement from City Ice Delivery Company to Georgia Power Company, dated October 13, 1969, filed November 13, 1969, Recorded in Deed Book 2481, Page 139, aforesaid records.
AFFECTS SITE - BLANKET EASEMENT - NOT PLOTTABLE
16. Right of Way Easement from Dobbs Houses, Division of Beech-Nut, Inc. to Georgia Power Company, dated September 20, 1969, filed November 13, 1969, Recorded in Deed Book 2481, Page 89, aforesaid records.
AFFECTS 3809 NORTH DRUID HILLS ROAD - BLANKET EASEMENT - NOT PLOTTABLE
17. Right of Way Easement from Dobbs Houses, Inc. to Georgia Power Company, dated December 9, 1969, filed January 30, 1970, Recorded in Deed Book 2501, Page 365, aforesaid records.
AFFECTS 3809 NORTH DRUID HILLS ROAD - BLANKET EASEMENT - NOT PLOTTABLE
18. Stormwater Detention Facility Inspection and Maintenance Agreement by and between Hendon Columbia, LLC and DeKalb County, Georgia, executed December 17, 2010, filed December 21, 2010, Recorded in Deed Book 22282, Page 388, aforesaid records.
AFFECTS SURVEY TRACT TWO - BLANKET EASEMENTS & RESTRICTIONS - NOT PLOTTABLE
19. All matters affecting subject property as shown on the following plats, all aforesaid records.
(A) Plat Book 24, Page 14 (Fee Simple);
NO EASEMENTS AFFECTING SITE DEPICTED ON DOCUMENT
(B) Plat Book 219, Page 113 (Easement Parcel 1);
NO EASEMENTS AFFECTING SITE DEPICTED ON DOCUMENT
(C) Plat Book 221, Page 52 (Easement Parcel 2);
NO EASEMENTS AFFECTING SITE DEPICTED ON DOCUMENT
As to Fee Parcel:
20. Memorandum of Lease by and between Citizens and Southern Trust Company (Georgia), N.A., as Trustees, et al, Romar Joint Venture and Pier 1 Imports (U.S.), Inc., a Delaware corporation, dated May 7, 1990, filed June 18, _____ and recorded in Deed Book 6727, Page 256, aforesaid records.
NOT A SURVEY MATTER
21. Easements as contained in that certain Right of Way Deed from O.S. Cofer to DeKalb County, Georgia, dated July 5, 1944, filed August 31, 1944 and recorded in Deed Book 606, Page 33, aforesaid records.
AFFECT SITE - BLANKET EASEMENT FOR DRAINAGE - NOT PLOTTABLE
22. Easements as contained in that certain Right of Way Deed from Robert C. Crim to DeKalb County, a political subdivision of the State of Georgia, dated October _____, 1988, filed October 18, 1988 and recorded in Deed Book 6270, Page 79, aforesaid records.
DOES NOT AFFECT SITE
As to Easement Parcel 2:
23. Assignment and Assumption of Declaration of Easements, Covenants and Restrictions among Hendon Columbia, LLC, and LG-SVAP NDM JV, LP, a Delaware limited liability company, dated May 9, 2014, filed May 15, 2014 and recorded in Deed Book 24380, Page 247, aforesaid records, as it affects that certain Declaration of Easements, Covenants and Restrictions by Hendon Columbia, LLC, a Georgia limited liability company, dated October 31, 2011, filed November 7, 2011 and recorded in Deed Book 22714, Page 748, aforesaid records.
AFFECTS SITE AS SHOWN

UTILITY NOTE

THE UNDERGROUND UTILITIES SHOWN HEREON ARE BASED ON LOCATION OF MARKINGS PROVIDED BY:

SUBSURFACE UTILITY INVESTIGATIONS, LLC
898 SWEET BRIAR TRAIL
CONYERS, GEORGIA 30094
(770) 557-4142

SUBSURFACE UTILITY INVESTIGATIONS, LLC UTILIZED SEVERAL TECHNIQUES INCLUDING, BUT NOT LIMITED TO, ELECTROMAGNETIC, MAGNETIC LOCATION FOR FERROUS METALS, ACOUSTIC AND PASSIVE FREQUENCIES TO DESIGNATE AND MARK BURIED UTILITIES ON THE SURFACE WITH PAINT AND FLAGS COVERING THE ENTIRE AREA OF THE PROJECT.

THE SURVEYOR MAKES NO GUARANTEES THAT THE UNDERGROUND UTILITIES SHOWN COMPRISE ALL SUCH UTILITIES IN THE AREA, EITHER IN-SERVICE OR ABANDONED, UNDERGROUND UTILITIES NOT OBSERVED OR LOCATED UTILIZING THIS TECHNIQUE MAY EXIST ON THIS SITE BUT NOT BE SHOWN, AND MAY BE FOUND UPON EXCAVATION. THE SURVEYOR FURTHER DOES NOT WARRANT THAT THE UNDERGROUND UTILITIES SHOWN ARE IN THE EXACT LOCATION INDICATED ALTHOUGH THE SURVEYOR DOES CERTIFY THAT THEY ARE LOCATED AS ACCURATELY AS POSSIBLE FROM INFORMATION AVAILABLE.

INFORMATION REGARDING MATERIAL AND SIZE OF UTILITIES IS BASED ON RECORDS ACQUIRED FROM THE UTILITY OWNERS.

PROPERTY DESCRIPTIONS

OVERALL PROPERTY DESCRIPTION

All that tract or parcel of land lying or being in Land Lot 100, 18th District, DeKalb County, Georgia, and being more particularly described as follows:

Beginning at an X mark found at the intersection of the Easterly right-of-way of Birch Road (60 foot right-of-way) with the Southerly right-of-way of North Druid Hills Road (100 foot right-of-way); thence along said right-of-way of North Druid Hills Road South 70 degrees 28 minutes 40 seconds East, a distance of 233.65 feet to a 5/8 inch rebar set; thence leaving said right-of-way South 19 degrees 08 minutes 30 seconds West, a distance of 140.15 feet to a 5/8 inch rebar set; thence South 12 degrees 24 minutes 24 seconds West, a distance of 52.60 feet to a 1/2 inch rebar found; thence South 12 degrees 22 minutes 11 seconds West, a distance of 30.67 feet to a 5/8 inch rebar found; thence South 71 degrees 24 minutes 15 seconds East, a distance of 160.12 feet to a 5/8 inch rebar found; thence South 11 degrees 56 minutes 08 seconds West, a distance of 109.33 feet to a 1/2 inch rebar found on the Northerly right-of-way of Sweet Briar Road (variable right-of-way); thence along said right-of-way North 79 degrees 52 minutes 39 seconds West, a distance of 400.37 feet to a 1/2 inch rebar found on the Easterly right-of-way of Birch Road; thence along said right-of-way North 09 degrees 14 minutes 08 seconds East, a distance of 86.03 feet to a 5/8 inch rebar found; thence North 17 degrees 25 minutes 03 seconds East, a distance of 109.86 feet to a 1/2 inch rebar found; thence North 18 degrees 08 minutes 19 seconds East, a distance of 119.69 feet to a nail found; thence North 17 degrees 57 minutes 53 seconds East, a distance of 79.90 feet to an X mark found, said point being the True Point of Beginning.

Said tract of land contains 2.485 Acres.

TRACT ONE PROPERTY DESCRIPTION

All that tract or parcel of land lying or being in Land Lot 100, 18th District, DeKalb County, Georgia, and being more particularly described as follows:

Beginning at an X mark found at the intersection of the Easterly right-of-way of Birch Road (60 foot right-of-way) with the Southerly right-of-way of North Druid Hills Road (100 foot right-of-way); thence along said right-of-way of North Druid Hills Road South 70 degrees 28 minutes 40 seconds East, a distance of 233.65 feet to a 5/8 inch rebar set; thence leaving said right-of-way South 19 degrees 08 minutes 30 seconds West, a distance of 140.15 feet to a 5/8 inch rebar set; thence South 12 degrees 24 minutes 24 seconds West, a distance of 52.60 feet to a 1/2 inch rebar found; thence North 72 degrees 13 minutes 06 seconds West, a distance of 236.14 feet to a 1/2 inch rebar found on the Easterly right-of-way of Birch Road; thence along said right-of-way North 18 degrees 08 minutes 19 seconds East, a distance of 119.69 feet to a nail found; thence North 17 degrees 57 minutes 53 seconds East, a distance of 79.90 feet to an X mark found, said point being the True Point of Beginning.

Said tract of land contains 1.047 Acres.

TRACT TWO PROPERTY DESCRIPTION

All that tract or parcel of land lying or being in Land Lot 100, 18th District, DeKalb County, Georgia, and being more particularly described as follows:

Commencing at an X mark found at the intersection of the Easterly right-of-way of Birch Road (60 foot right-of-way) with the Southerly right-of-way of North Druid Hills Road (100 foot right-of-way); thence along said right-of-way of Birch Road South 17 degrees 57 minutes 53 seconds West, a distance of 79.90 feet to a nail found; thence South 18 degrees 08 minutes 19 seconds West, a distance of 119.69 feet to a 1/2 inch rebar found; thence South 71 degrees 24 minutes 15 seconds East, a distance of 160.12 feet to a 5/8 inch rebar found; thence South 11 degrees 56 minutes 08 seconds East, a distance of 109.33 feet to a 1/2 inch rebar found on the Northerly right-of-way of Sweet Briar Road (variable right-of-way); thence along said right-of-way North 79 degrees 52 minutes 39 seconds West, a distance of 400.37 feet to a 1/2 inch rebar found on the Easterly right-of-way of Birch Road; thence along said right-of-way North 09 degrees 14 minutes 08 seconds East, a distance of 86.03 feet to a 5/8 inch rebar found; thence North 17 degrees 25 minutes 03 seconds East, a distance of 109.86 feet to a 1/2 inch rebar found, said point being the True Point of Beginning.

Said tract of land contains 1.438 Acres.

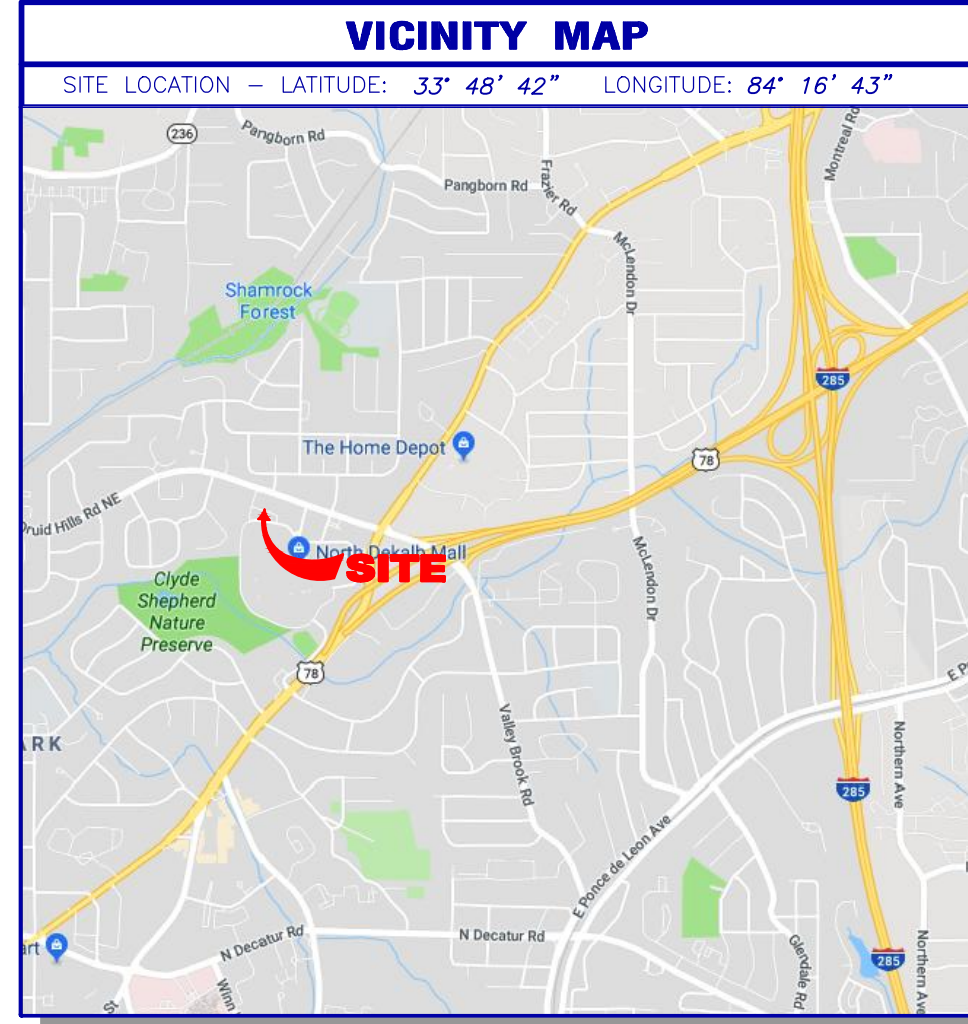

GENERAL NOTES

THIS SURVEY HAS BEEN PREPARED FOR THE EXCLUSIVE USE OF THE PERSON OR ENTITIES NAMED HEREON. NO EXPRESS OR IMPLIED WARRANTIES WITH RESPECT TO THE INFORMATION SHOWN HEREON IS TO BE EXTENDED TO ANY PERSONS OR ENTITIES OTHER THAN THOSE SHOWN HEREON.

REVISIONS LISTED ON THIS SURVEY APPLY ONLY TO THE SPECIFIC CHANGES REFERENCED, AND DO NOT CONSTITUTE AN UPDATE OF OTHER DATA ON THIS SURVEY. THE SURVEY DATE SHOWN HEREON IS THE APPLICABLE DATE AS RELATED TO PROVISIONS OF STATUTES OF LIMITATION UNLESS SPECIFICALLY NOTED OTHERWISE.

THIS PROPERTY IS NOT LOCATED IN A SPECIAL FLOOD HAZARD AREA BASED ON THE FLOOD INSURANCE RATE MAP FOR THIS AREA. THE MAP NUMBER FOR THIS AREA IS 13089C0067K, AND THE DATE OF SAID MAP IS AUGUST 15, 2019. THIS DETERMINATION WAS MADE BY GRAPHICALLY DETERMINING THE POSITION OF THIS SITE ON SAID FIRM MAPS UNLESS OTHERWISE NOTED.

PLEASE NOTE: TREES 4-INCH DBH (DIAMETER AT BREAST HEIGHT) AND LARGER WERE LOCATED FOR THIS SURVEY.

RIGHT-OF-WAY LINES SHOWN ON THIS SURVEY THAT ARE NOT ACTUAL BOUNDARIES OF THE SUBJECT TRACT(S) ARE DEPICTED GRAPHICALLY AND ARE SHOWN APPROXIMATELY FOR INFORMATIONAL PURPOSES ONLY. SAID RIGHT-OF-WAY LINES SHOULD NOT BE UTILIZED FOR DESIGN PURPOSES.

THE DATUM FOR THIS SITE WAS ESTABLISHED UTILIZING GLOBAL POSITIONING SYSTEMS, AND BASED ON POSITIONAL VALUES FOR THE VIRTUAL REFERENCE STATION NETWORK DEVELOPED BY eGPS SOLUTIONS. THE HORIZONTAL REFERENCE FRAME IS NORTH AMERICAN DATUM OF 1983(2011)-STATE PLANE COORDINATE SYSTEM OF GEORGIA-WEST ZONE. THE VERTICAL REFERENCE FRAME IS NORTH AMERICAN VERTICAL DATUM OF 1988. ANY DIRECTIONS OR DIMENSIONS SHOWN ARE A RECTANGULAR, GROUND LEVEL PROJECTION OF THE STATE PLANE COORDINATE SYSTEM.

NO EVIDENCE OF THE SITE BEING USED AS A SOLID WASTE DUMP, SUMP OR SANITARY LANDFILL WAS OBSERVED DURING THE TIME FIELD WORK WAS PERFORMED ON THE SUBJECT PARCEL.

ALL MATTERS SHOWN ON RECORDED PLATS PROVIDED TO THE SURVEYOR ARE SHOWN ON THE SURVEY.

AT THE DATE OF THIS SURVEY, THE SUBJECT PROPERTY HAD ACCESS TO AND FROM A DULY DEDICATED PUBLIC RIGHT-OF-WAY, NORTH DRUID HILLS ROAD AND BIRCH ROAD. THE SURVEYOR MAKES NO CERTIFICATION AS TO WHETHER OR NOT THESE ACCESS POINTS HAVE BEEN APPROVED OR PERMITTED BY JURISDICTIONAL AUTHORITIES.

THE SUBJECT PROPERTY IS CONTIGUOUS WITH ADJACENT RIGHT-OF-WAYS WITHOUT GAPS, GORES, OR OVERLAPS.

NO VISIBLE ABOVE-GROUND ENCROACHMENTS WERE OBSERVED AT THE DATE OF SURVEY.

ALTA CERTIFICATION TABLE "A" NOTES:
Item 16 - No evidence of current earth moving work, building construction or building additions was observed at the date of survey.
Item 17 - No evidence was observed indicating changes in street right of way lines either completed or proposed.

SURVEY REFERENCES
1> ALTA/NSPS LAND TITLE SURVEY OF NORTH DEKALB MALL, PREPARED BY GEOSURVEY, LTD., DATED DECEMBER 15, 2021. (JOB NO. 20175643)

CLOSURE STATEMENT

THE FIELD CLOSURE UPON WHICH THIS PLAT IS BASED HAS A CLOSURE PRECISION OF ONE FOOT IN 149,226, AND WAS ADJUSTED USING THE LEAST SQUARES METHOD. A TRIMBLE S-6 TOTAL STATION AND TRIMBLE TSC-3 DATA COLLECTOR WERE USED TO COLLECT THIS FIELD DATA.

THIS PLAT HAS BEEN CALCULATED FOR CLOSURE AND WAS FOUND TO BE ACCURATE WITHIN ONE FOOT IN 699,292 FEET. JDL INT.

IF YOU DIG



Know what's below.
Call before you dig.
Dial 811
Or Call 800-282-7411

GRAPHIC SCALE

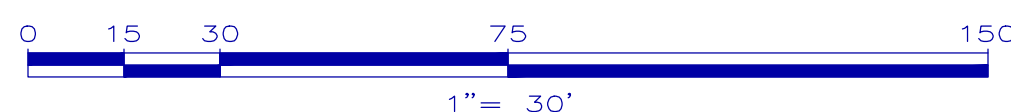

N/F PROPERTY OF
MIDTOWN NATIONAL GROUP, LP
DEED BOOK 225963 / PAGE 770
DEED BOOK 26135 / PAGE 636
DEED BOOK 26453 / PAGE 394
TRACT ONE
1.047 Acres
45,590 sf
ZONED NS
LCI-SVAP NDM JV, LP
DEED BOOK 24380 / PAGE 239
DEED BOOK 24380 / PAGE 244
TRACT TWO
1.438 Acres
62,662 sf
ZONED C-1
TOTAL SITE AREA
2.485 Acres
108,252 sf

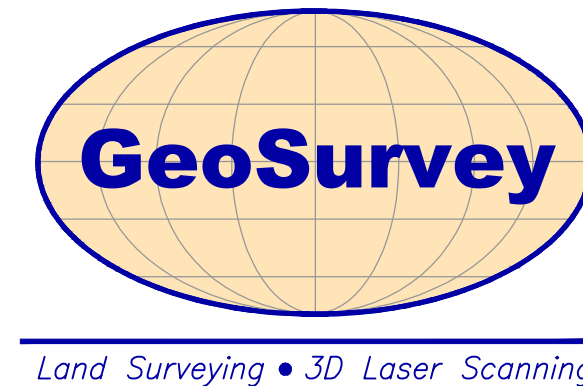

Land Surveying • 3D Laser Scanning

1660 Barnes Mill Road
Marietta, Georgia 30062

Phone: (770) 795-9900
Fax: (770) 795-8880

www.geosurvey.com
EMAIL: info@geosurvey.com
Certificate of Authorization #LSF-000621

2 SHEET
OF
2

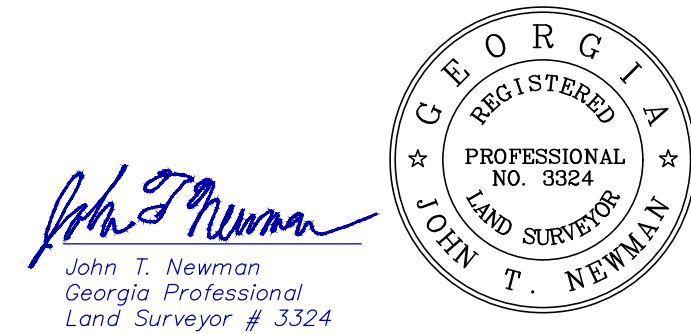
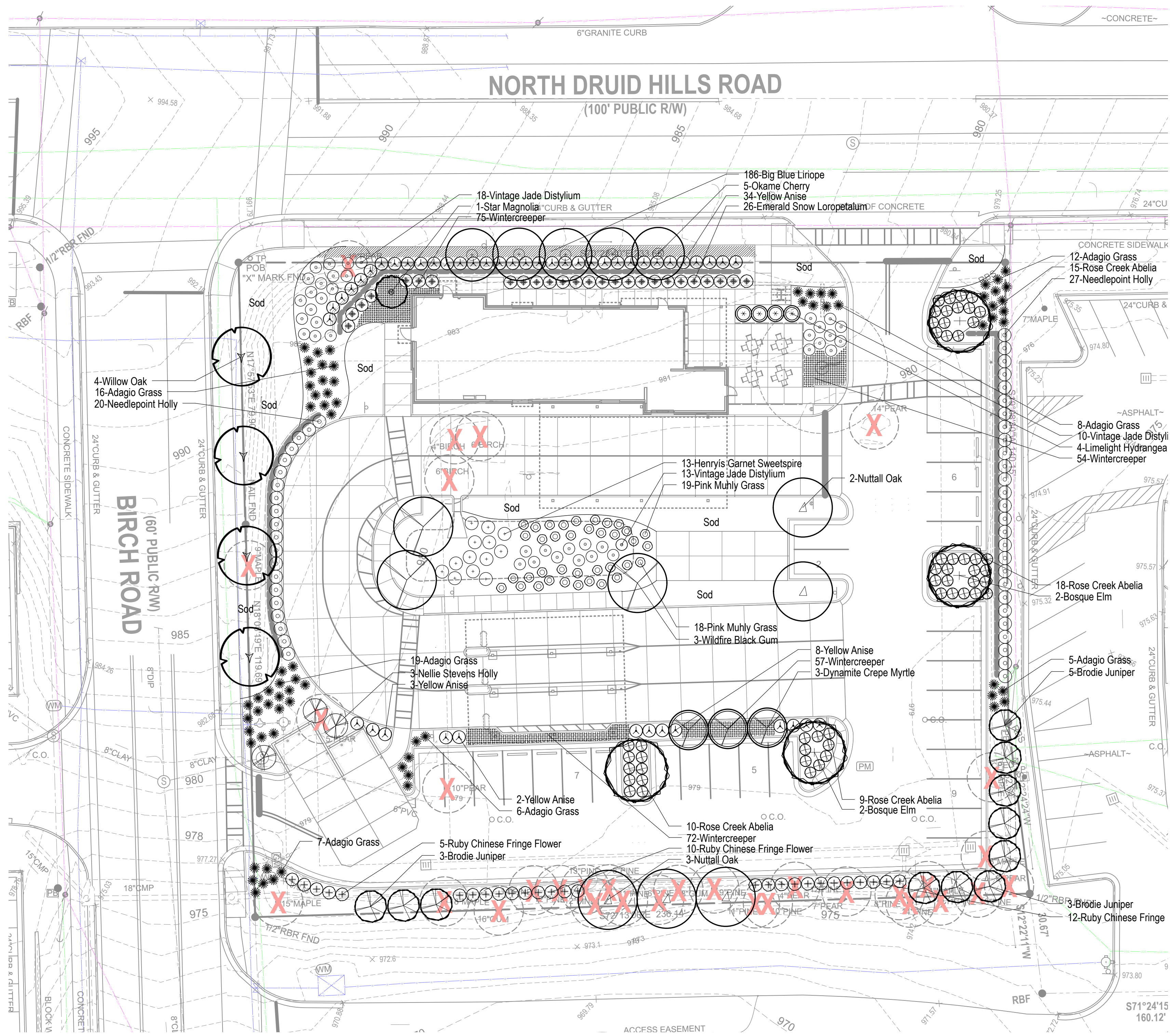

Table with 4 columns: ES JOB NO., DRAWING SCALE, SURVEY DATE, FIELD WORK, PROJ. MGR., REVIEWED, DWG FILE, CITY, COUNTY, STATE, LAND LOT, DISTRICT, and SURVEY DATE. Includes details for 3795 North Druid Hills Rd & 2692 Sweet Briar Rd.

EXHIBIT E



PLANT LIST

Qty	Botanical Name	Common Name	Scheduled Size	Remarks
Trees				
3	Ilex x Nellie R Stevens	Nellie Stevens Holly	5'-6" Hgt. B&B	
11	Juniperus virginiana 'Brodie'	Brodie Juniper	8'-10' Hgt.	
3	Lagerstroemia indica 'Whit II'	Dynamite Crepe Myrtle	7'-8' Hgt.	
1	Magnolia stellata	Star Magnolia	6'-8' Hgt.	
3	Nyssa sylvatica 'Wildfire'	Wildfire Black Gum	3" Cal.; 10' Hgt.	B & B; single straight leader
5	Prunus 'Okame'	Okame Cherry	2" Cal.; 10' Hgt. Minimum	
5	Quercus nuttallii	Nuttall Oak	3" Cal.; 10' Hgt.	B & B; single straight leader
4	Quercus phellos	Willow Oak	3" Cal.; 10' Hgt.	B & B; single straight leader
4	Ulmus parvifolia 'Bosque'	Bosque Elm	3" Cal.; 10' Hgt.	B & B
Shrubs				
52	Abelia x chinensis 'Rose Creek'	Rose Creek Abelia	3 Gal.	
41	Distylium 'Vintage Jade'	Vintage Jade Distylium	3 Gal.	
4	Hydrangea paniculata 'Limelight'	Limelight Hydrangea	3 Gal.	
47	Ilex cornuta 'Needlepoint'	Needlepoint Holly	3 Gal.	
47	Illicium parviflorum	Yellow Anise	3 Gal.	
13	Itea virginica 'Henry's Garnet'	Henry's Garnet Sweetspire	3 Gal.	
27	Loropetalum chinense 'Ruby'	Ruby Loropetalum	3 Gal. - 24"-36" Hgt.	
26	Loropetalum chinense 'Shang White'	Emerald Snow Loropetalum	3 Gal.	
73	Miscanthus sinensis 'Adagio'	Adagio Grass	3 Gal.	
37	Muhlenbergia capillaris	Pink Muhly Grass	3 Gal.	
Groundcovers				
258	Euonymus coloratus	Wintercreeper	1 Gal.	Plant 18" O.C.
186	Liriope muscari 'Big Blue'	Big Blue Liriope	1 Gal.	Plant 18" O.C.
Other				

NOTE:
This Landscape Plan is Preliminary in nature and is subject to change

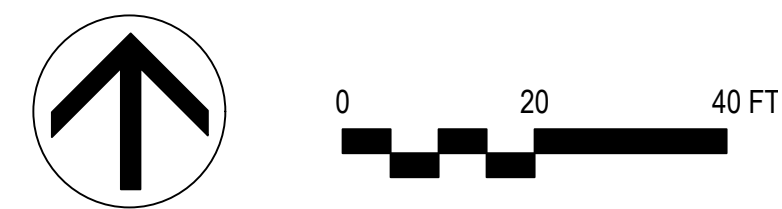

LANDSCAPE NOTES

SOUTHEAST

- Landscape Contractor to read and understand the Landscape Specifications (sheet L-102) prior to finalizing bids. The Landscape Specifications shall be adhered to throughout the construction process.
- Contractor is responsible for locating and protecting all underground utilities prior to digging.
- Contractor is responsible for protecting existing trees from damage during construction.
- All tree protection devices to be installed prior to the start of land disturbance, and maintained until final landscaping.
- All tree protection areas to be protected from sedimentation.
- All tree protection fencing to be inspected daily, and repaired or replaced as needed.
- No parking, storage or other construction activities are to occur within tree protection areas.
- All planting areas shall be cleaned of construction debris (ie. concrete, rock, rubble, building materials, etc) prior to adding and spreading of the topsoil.
- General Contractor is responsible for adding a min of 4" clean friable topsoil in all planting beds and all grassed areas. Graded areas to be held down the appropriate elevation to account for topsoil depth. See Landscape Specifications for required topsoil characteristics.
- In all parking lot islands, the General Contractor is responsible to remove all debris, fracture/loosen subgrade to a min. 24" depth. Add topsoil to a 6"-8" bermed height above island curbing; refer to landscape specifications and landscape island detail.
- Prior to beginning work, the Landscape Contractor shall inspect the subgrade, general site conditions, verify elevations, utility locations, irrigation, approve topsoil provided by the General Contractor and observe the site conditions under which the work is to be done. Notify the General Contractor of any unsatisfactory conditions, work shall not proceed until such conditions have been corrected and are acceptable to the Landscape Contractor.
- Any deviations from the approved set of plans are to be approved by the Landscape Architect.
- Landscaping shall be installed in conformance with ANSI Z60.1 the "American Standard for Nursery Stock" and the accepted standards of the American Association of Nurserymen.
- Existing grass in proposed planting areas shall be killed and removed. Hand rake to remove all rocks and debris larger than 1 inch in diameter, prior to adding topsoil and planting shrubs.
- Soil to be tested to determine fertilizer and lime requirements prior to laying sod.
- Annual and perennial beds: add min. 4 inch layer of organic material and till to a min. depth of 12 inches. Mulch annual and perennial beds with 2-3 inch depth of mini nuggets.
- All shrubs beds (existing and new) to be mulched with a min. 3 inch layer of mulch (double shredded hardwood mulch).
- Planting holes to be dug a minimum of twice the width of the root ball, for both shrub and tree. Set plant material 2-3" above finish grade. Backfill planting pit with topsoil and native excavated soil. Set plant material 2-3" above finish grade. Backfill planting pit with topsoil and native excavated soil.
- Sod to be delivered fresh (Cut less than 24 hours prior to arriving on site), laid immediately, rolled, and watered thoroughly immediately after planting. Edge of sod at planting beds are to be "V" trenched; see Landscape Details.
- Any existing grass disturbed during construction to be fully removed, regraded and replaced. All tire marks and indentations to be repaired.
- Water thoroughly twice in first 24 hours and apply mulch immediately.
- The Landscape Contractor shall guarantee all plants installed for one full year from date of acceptance by the owner. All plants shall be alive and at a vigorous rate of growth at the end of the guarantee period. The Landscape Contractor shall not be responsible for acts of God or vandalism. See Landscape Specifications for Warranty requirements/expectations.
- Any plant that is determined dead, in an unhealthy, unsightly condition, lost its shape due to dead branches, or other symptoms of poor, non-vigorous growth, shall be replaced by the Landscape Contractor. See Landscape Specifications for warranty requirements/expectations.
- Site to be 100% irrigated in all planting beds and grass area by an automatic underground irrigation system. See Irrigation Plan L-200 for design. Irrigation as-built shall be provided to the Landscape Architect within 24 hours of irrigation install completion.
- Stake all evergreen and deciduous trees as shown in the planting detail and as per the Landscape Specifications.
- Remove stakes and guying from all trees after one year from planting.

LEGEND

- EXISTING TREE TO BE REMOVED
- EXISTING TREE TO REMAIN
- TREE PROTECTION FENCING



Chick-fil-A
5200 Buffington Road
Atlanta, Georgia 30349-2998



770.442.8171 tel
770.442.1123 fax

Manley Land Design, Inc.
51 Old Canton Street
Alpharetta, Georgia 30009

manleylanddesign.com



CHICK-FIL-A
NORTH DRUID HILLS DTO
3795 North Druid Hills Road
Decatur, GA 30033

FSU# 4846

REVISION SCHEDULE
NO. DATE DESCRIPTION

MLD PROJECT # 2021062

PRINTED FOR

DATE 4.9.21

DRAWN BY MB

Information contained on this drawing and in all digital files produced for above named project may not be reproduced in any manner without express written or verbal consent from authorized project representatives.

SHEET

Landscape Plan

SHEET NUMBER

L-100

EXHIBIT F



EXTERIOR ELEVATION
1" = 10'-0"



EXTERIOR ELEVATION
1" = 10'-0"

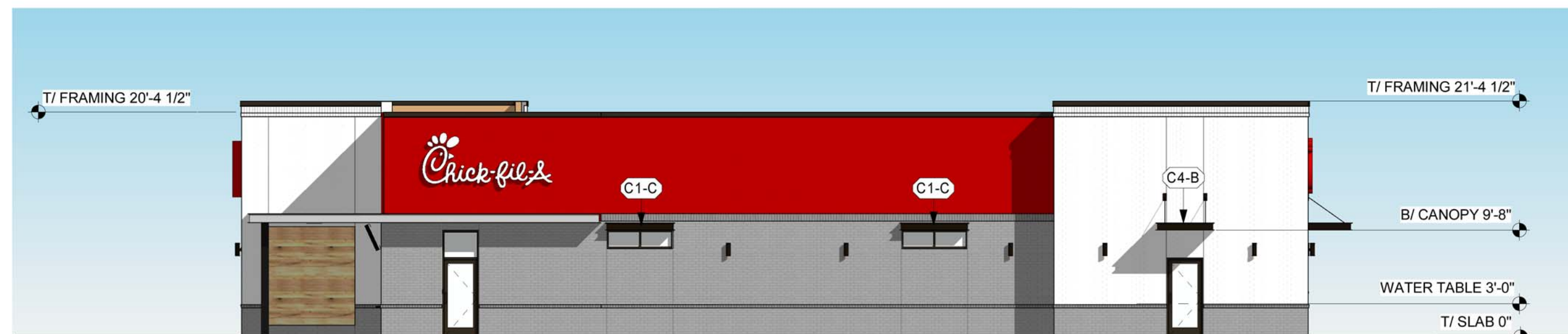

EXTERIOR ELEVATION
1" = 10'-0"



EXTERIOR ELEVATION
1" = 10'-0"



DEKALB COUNTY GOVERNMENT
PLANNING DEPARTMENT
DISTRIBUTION FORM

NOTE: PLEASE RETURN ALL COMMENTS VIA EMAIL OR FAX TO EXPEDITE THE PROCESS TO MICHELLE M ALEXANDER mmalexander@dekalbcountyga.gov OR JOHN REID jreid@DEKALBCOUNTYGA.GOV

COMMENTS FORM:
PUBLIC WORKS WATER AND SEWER

Case No.: Z-21-1244885

Parcel I.D. #: 18-100-04-019

Address: 3795 North Druid Hills Road
Decatur, Georgia

WATER:

Size of existing water main: 6" CI & 12" DI Water Main (adequate/inadequate)

Distance from property to nearest main: Adjacent to Property

Size of line required, if inadequate: N/A

SEWER:

Outfall Servicing Project: South Fork Peachtree Creek Basin

Is sewer adjacent to property: Yes (X) No () If no, distance to nearest line: _____

Water Treatment Facility: R. M. Clayton WTF () adequate () inadequate

Sewage Capacity: * (MGPD) Current Flow: 127 (MGPD)

COMMENTS:

* Please note that the sewer capacity has not been reviewed or approved for this project. A Sewer Capacity Request (SCR) must be completed and submitted for review. This can be a lengthy process and should be addressed early in the process.

SCR submitted 06/02/21 still processing.
A Jayson

Signature: [Signature]

Zoning Comments

N1 & N2 (Z-21-1244885 & SLUP-21-1244886) - North Druid Hills is classified as a major arterial. Required to add a left turn lane onto Birch. Drive on North Druid Hills limited to Right in/right out only. Please see chapter 5 of the zoning code and chapter 14-190 of the land development code for infrastructure requirements. Requires 10 foot landscape strip, bike lanes and 6 foot sidewalks or 10 foot multiuse path (preferred), street lighting on back of sidewalk. Right of way dedication of 50 feet from centerline or such that all public infrastructure is within county right of way, whichever greater. Birch Road is classified as a local street. Requires a 27.5 foot right of way dedication from the centerline or such that all public infrastructure is on county right of way. Due to the proximity of the mall, potential for redevelopment and connectivity the residential areas- a 10 foot multiuse trail to be included in the sight design along Birch. Requires a 6 foot landscape strip. Streetlights required on back of path.

N3. (Z-21-1244892) Flakes Mill Road is classified as a minor arterial. Access point on Flakes Mill Road must meet intersection sight distance prior to permitting and verified prior to occupancy by the engineer of record. Please see chapter 5 of the zoning code and chapter 14-190 of the land development code for infrastructure requirements. Requires 10 foot landscape strip, bike lanes and 6 foot sidewalks or 10 foot multiuse path (preferred), street lighting on back of sidewalk. Right of way dedication of 40 feet from centerline or such that all public infrastructure is within county right of way, whichever greater. New residential streets will be local with a right of way of 55 feet, 24 feet of pavement, curb and gutter, 6 foot landscape strip, a 6 foot sidewalk, street lighting required behind sidewalk.

N4. (Z-21-1244893) Norman Road is classified as a collector road. Please see chapter 5 of the zoning code and chapter 14-190 of the land development code for infrastructure requirements. Requires 10 foot landscape strip, bike lanes and 6 foot sidewalks or 10 foot multiuse path (preferred), street lighting on back of sidewalk. Right of way dedication of 35 feet from centerline or such that all public infrastructure is within county right of way, whichever greater. New residential streets will be local with a right of way of 55 feet, 24 feet of pavement, curb and gutter, 6 foot landscape strip, a 6 foot sidewalk, street lighting required on back of sidewalk. Continue at least 2 traffic calming features (splitter islands) similar to the ones installed in the City of Clarkton along frontage.

N5. (SLUP-21-1244895) No comment

N6. (SLUP-21-1244899) No comment



Board of Health

06/21/2021

To: Mr. John Reid, Senior Planner
From: Ryan Cira, Environmental Health Manager
Cc: Alan Gaines, Technical Services Manager
Re: Rezone Application Review

General Comments:

DeKalb County Health Regulations prohibit use of on-site sewage disposal systems for

- multiple dwellings
- food service establishments
- hotels and motels
- commercial laundries
- funeral homes
- schools
- nursing care facilities
- personal care homes with more than six (6) clients
- child or adult day care facilities with more than six (6) clients
- residential facilities containing food service establishments

If proposal will use on-site sewage disposal, please contact the Land Use Section (404) 508-7900.

Any proposal, which will alter wastewater flow to an on-site sewage disposal system, must be reviewed by this office prior to construction.

This office must approve any proposed food service operation or swimming pool prior to starting construction.

Public health recommends the inclusion of sidewalks to continue a preexisting sidewalk network or begin a new sidewalk network. Sidewalks can provide safe and convenient pedestrian access to a community-oriented facility and access to adjacent facilities and neighborhoods.

For a public transportation route, there shall be a 5ft. sidewalk with a buffer between the sidewalk and the road. There shall be enough space next to sidewalk for bus shelter's concrete pad installation. Recommendation: Provide trash can with liner at each bus stop with bench and monitor for proper removal of waste.

Since DeKalb County is classified as a Zone 1 radon county, this office recommends the use of radon resistant construction.



Board of Health

- N.1 Z-21-1244885 2021-2678/18-100-04-019
District 02 Super District 06
3795 North Druid Hills Road, Decatur, GA 30033
Acres: 1.04
- Please review general comments.
 - NS to C-1
- N.2 SLUP-21-1244886 2021-2638/18-100-04-019
District 02 Super District 06
3795 North Druid Hills Road, Decatur, GA 30033
Acres: 1.04
- Please review general comments.
 - SLUP to allow drive through facility through in Town Center Character area.
- N.3 Z-21-1244892 2021-2640/12-253-03-002
District 03 Super District 07
5035 Flakes Mills Road, Ellenwood, GA 30294
Acres: 27
- Septic system installed on several surrounding properties in the past.
 - Please review general comments.
 - R-100 to R-60
- N.4 Z-21-1244893 2021-2641/18-095-03-005, 18-095-03-006, 18-095-03-008, 18-095-03-009, 18-095-03-090, 18-095-03-094
District 04 Super District 06
3943 Norman Road, Stone Mountain, GA 30083
Acres: 35
- Septic system installed on several surrounding properties in the past.
 - Please review general comments.
 - R-85 to RSM
- N.5 SLUP-21-1244895 2021-2641/15-137-03-028
District 03 Super Districts 06
2445 Candler Road, Decatur, GA 30032
Acres: 0.3
- Dental Building at time septic installed on 12/4/1962.
 - Please review general comments.
 - SLUP to Housing Facility



Board of Health

N.6 SLUP-21-1244899 2021/2643/15-084-05-068
District 03 Super District 06
3008 Rollingwood Lane, Atlanta, GA 30316
Acres: 0.35
- Septic system installed 8/19/1960.
- Please review general comments.

N.7 TA-21-1244945 2021-2644
Districts 03 & 05 Super District 07
- Please review general comments.

N.8 TA-21-1244999 2021-2645
Districts 03 & 05 Super District 07
- Please review general comments.



DEKALB COUNTY GOVERNMENT
PLANNING DEPARTMENT
DISTRIBUTION FORM

NOTE: PLEASE RETURN ALL COMMENTS VIA EMAIL OR FAX TO EXPEDITE THE PROCESS TO MICHELLE ALEXANDER mmalexander@dekalbcountvga.gov AND/OR LASONDRA HILL lahill@dekalbcountvga.gov

**COMMENTS FORM:
PUBLIC WORKS TRAFFIC ENGINEERING**

Case No.: 2-21-1244885 Parcel I.D. #: 18-100-04-019

Address: 3795
N. David Hills Rd
Decatur Ga

Adjacent Roadway (s):

(classification) (classification)

Capacity (TPD) _____	Capacity (TPD) _____
Latest Count (TPD) _____	Latest Count (TPD) _____
Hourly Capacity (VPH) _____	Hourly Capacity (VPH) _____
Peak Hour. Volume (VPH) _____	Peak Hour. Volume (VPH) _____
Existing number of traffic lanes _____	Existing number of traffic lanes _____
Existing right of way width _____	Existing right of way width _____
Proposed number of traffic lanes _____	Proposed number of traffic lanes _____
Proposed right of way width _____	Proposed right of way width _____

Please provide additional information relating to the following statement.

According to studies conducted by the Institute of Traffic Engineers (ITE) 6/7TH Edition (whichever is applicable), churches generate an average of fifteen (15) vehicle trip end (VTE) per 1, 000 square feet of floor area, with an eight (8%) percent peak hour factor. Based on the above formula, the _____ square foot place of worship building would generate _____ vehicle trip ends, with approximately _____ peak hour vehicle trip ends.

Single Family residence, on the other hand, would generate ten (10) VTE's per day per dwelling unit, with a ten (10%) percent peak hour factor. Based on the above referenced formula, the _____ (Single Family Residential) District designation which allows a maximum of _____ units per acres, and the given fact that the project site is approximately _____ acres in land area, _____ daily vehicle trip end, and _____ peak hour vehicle trip end would be generated with residential development of the parcel.

COMMENTS:

Field & plans reviewed. Nothing found that would interrupt traffic flow.

Signature: [Signature]

N-2



DEKALB COUNTY GOVERNMENT
PLANNING DEPARTMENT
DISTRIBUTION FORM

NOTE: PLEASE RETURN ALL COMMENTS VIA EMAIL OR FAX TO EXPEDITE THE PROCESS TO MICHELLE ALEXANDER mmalexander@dekalbcountyga.gov AND/OR LASONDRA HILL lahill@dekalbcountyga.gov

COMMENTS FORM:
PUBLIC WORKS TRAFFIC ENGINEERING

Case No.: SLUP-21-1244886 Parcel I.D. #: 18-100-04-019

Address: 3795
N. David Hill Rd
Decatur, GA

Adjacent Roadway (s):

(classification) (classification)

Capacity (TPD) _____	Capacity (TPD) _____
Latest Count (TPD) _____	Latest Count (TPD) _____
Hourly Capacity (VPH) _____	Hourly Capacity (VPH) _____
Peak Hour Volume (VPH) _____	Peak Hour Volume (VPH) _____
Existing number of traffic lanes _____	Existing number of traffic lanes _____
Existing right of way width _____	Existing right of way width _____
Proposed number of traffic lanes _____	Proposed number of traffic lanes _____
Proposed right of way width _____	Proposed right of way width _____

Please provide additional information relating to the following statement.

According to studies conducted by the Institute of Traffic Engineers (ITE) 6/7TH Edition (whichever is applicable), churches generate an average of fifteen (15) vehicle trip end (VTE) per 1,000 square feet of floor area, with an eight (8%) percent peak hour factor. Based on the above formula, the _____ square foot place of worship building would generate _____ vehicle trip ends, with approximately _____ peak hour vehicle trip ends.

Single Family residence, on the other hand, would generate ten (10) VTE's per day per dwelling unit, with a ten (10%) percent peak hour factor. Based on the above referenced formula, the _____ (Single Family Residential) District designation which allows a maximum of _____ units per acres, and the given fact that the project site is approximately _____ acres in land area, _____ daily vehicle trip end, and _____ peak hour vehicle trip end would be generated with residential development of the parcel.

COMMENTS:

Field and plans reviewed. Nothing found that would disrupt traffic pattern/flow.

Signature: [Signature]

NEXT STEPS

Following an approval of this zoning action, one or several of the following may be required:

Land Disturbance Permit *(Required for of new building construction on non-residential properties, or land disturbance/improvement such as storm water detention, paving, digging, or landscaping.)*

Building Permit *(New construction or renovation of a building (interior or exterior) may require full plan submittal or other documentation. zoning, site development, watershed and health department standards will be checked for compliance.)*

Certificate of Occupancy *(Required prior to occupation of a commercial space and for use of property for any business type. The issuance follows the review of submitted plans if required based on the type occupancy.)*

Plat Approval *(Required if any parcel is being subdivided, re-parceled, or combined. Issued “administratively”; no public hearing required.)*

Sketch Plat Approval *(Required for the subdivision of property into three lots or more. Requires a public hearing by the Planning Commission.)*

Overlay Review *(Required review of development and building plans for all new construction or exterior modification of building(s) located within a designated overlay district.)*

Historic Preservation *(Certificate of Appropriateness required for any proposed changes to building exteriors or improvements to land when located within the Druid Hills or the Soapstone Geological Historic Districts. Historic Preservation Committee public hearing may be required.)*

Variance or Special Exception *(Required seeking relief from any development standards of the Zoning Ordinance. A public hearing and action by the Board of Appeals are required for most variances.)*

Minor Modification *(Required if there are any proposed minor changes to zoning conditions that were approved by the Board of Commissioners. The review is administrative if the changes are determined to be minor as described by Zoning Code.)*

Major Modification *(Required submittal of a complete zoning application for a public hearing if there are any proposed changes to zoning conditions approved by the Board of Commissioner on a prior rezoning.)*

Business License *(Required for any business or non-residential enterprise operating in Unincorporated DeKalb County, including in-home occupations).*

Alcohol License *(Required permit to sell alcohol for consumption on-site or packaged for off-site consumption. Signed and sealed distance survey is required. Background checks will be performed.)*

Each of the approvals and permits listed above require submittal of application, fees and supporting documents. Please consult with the appropriate department/division.